

## 664HC4102K2EM8

Conduction Cooled (High Density Resonant)

Parts are RoHS compliant

Parts are RoHS compliant

### ELECTRICAL SPECIFICATIONS

Capacitance: 0.66  $\mu$ F

AC Current: 600 A

ESR: 0.8 milliOhms at 100 kHz and 20°C

Self Inductance: 5 Nanohenries maximum

Tolerance: -10 %, +10 %

Temperature Range: -40°C to +85°C

Maximum Core Temperature: 85°C

Resonant Frequency: 95-216 kHz

Maximum power (KVAR): 400

VAC: 1000 Volts AC

### PHYSICAL DIMENSIONS

Length (L): 56 mm, 0.5 mm

Height (H): 66 mm, +/-0.1 mm

Thickness (B): 30.2 mm, +/-0.1 mm

LEAD STYLE: 2EM8

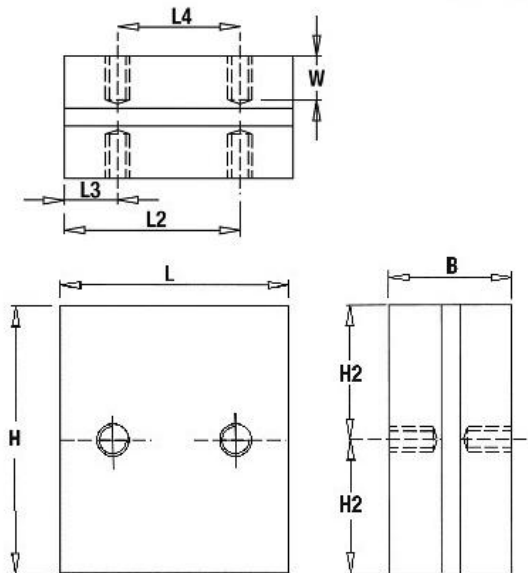

L	H	B	W	L2	L3	L4	H2
56±0.5	66±0.5	30.2±0.1	9	43	13	30	27.5
Mounting holes: M8 full thread with SS helicoil							
Tightening torque: 15Nm MAX							



3757 W. Touhy Ave. Lincolnwood, IL 60712 (847) 675-1760 FAX (847) 673-2850  
Illinois Capacitor (HK) Ltd., Tel: 85227930931, Fax: 85227930731, [www.illcap.com.hk](http://www.illcap.com.hk)  
© Copyright 2017 Illinois Capacitor. A division of Cornell Dublier, All Rights Reserved