

# PXE30-xxDxx Dual Output DC/DC Converter

9 to 18 Vdc , 18 to 36 Vdc , or 36 to 75 Vdc input, 12 to 15 Vdc Dual Output, 30W



## **APPLICATIONS**

Wireless Network  
Telecom/Datacom  
Industry Control System  
Measurement Equipment  
Semiconductor Equipment

## **Features**

- 30 watts maximum output power
- Output current up to 1250mA
- Standard 2" x 1.6" x 0.4" package
- High efficiency up to 88%
- 2:1 wide input voltage range
- Six-sided continuous shield
- Fixed switching frequency
- CE MARK meets 2006/95/EC, 93/68/EEC and 2004/108/EC
- UL60950-1, EN60950-1 and IEC60950-1 licensed
- ISO9001 certified manufacturing facilities
- Compliant to RoHS EU directive 2002/95/EC

## **Options**

- Heat sinks available for extended operation

## **General Description**

The PXE30-xxDxx series offers 30 watts of output power in a 2 x 1.6 x 0.4 inch package . This series has a 2:1 wide input voltage of 9-18VDC, 18-36VDC or 36-75VDC and features 1600VDC of isolation, short-circuit and over-voltage protection.

## **Table of Contents**

Absolute Maximum Rating	P2	Heat Sink Consideration	P22
Output Specification	P2	Remote ON/OFF Control	P23
Input Specification	P3	Mechanical Data	P24
General Specification	P4	Recommended Pad Layout	P25
Characteristic Curves	P5	Output Voltage Adjustment	P26
Test Configurations	P17	Soldering and Reflow Consideration	P27
EMC Considerations	P18	Packaging Information	P27
Input Source Impedance	P20	Part Number Structure	P28
Output Over Current Protection	P20	Safety and Installation Instruction	P28
Output Over Voltage Protection	P21	MTBF and Reliability	P28
Short Circuit Protection	P21		
Thermal Consideration	P21		

Absolute Maximum Rating				
Parameter	Model	Min	Max	Unit
Input Voltage	Continuous	12Dxx	18	V <sub>DC</sub>
		24Dxx	36	
		48Dxx	75	
	Transient (100mS)	12Dxx	36	
		24Dxx	50	
		48Dxx	100	
Input Voltage Variation (complies with EST300 132 part 4.4)	All		5	V/mS
Operating Ambient Temperature (with derating)	All	-40	85	°C
Operating Case Temperature	All		100	°C
Storage Temperature	All	-55	105	°C

Output Specification					
Parameter	Model	Min	Typ	Max	Unit
Output Voltage (V <sub>in</sub> = V <sub>in</sub> (nom) ; Full Load ; T <sub>A</sub> =25°C)	xxD12	11.88	12	12.12	V <sub>DC</sub>
	xxD15	14.85	15	15.15	
Voltage Adjustability	All	-10		+10	%
Output Regulation Line (V <sub>in</sub> (min) to V <sub>in</sub> (max) at Full Load) Load (Min. to 100% of Full Load)	All	-0.5		+0.5	%
		-1		+1	
Output Ripple & Noise Peak-to-Peak (20MHz bandwidth) (Measured with a 0.1μF/50V MLCC)	xxD12		100		mVp-p
	xxD15		100		
Temperature Coefficient	All	-0.02		+0.02	%/°C
Output Voltage Overshoot (V <sub>in</sub> (min) to V <sub>in</sub> (max) ; Full Load ; T <sub>A</sub> =25°C)	All		0	5	% V <sub>OUT</sub>
Dynamic Load Response (V <sub>in</sub> = V <sub>in</sub> (nom) ; T <sub>A</sub> =25°C) Load step change from 75% to 100% or 100 to 75% of Full Load Peak Deviation Setting Time (V <sub>OUT</sub> < 10% peak deviation)	All		250		mV
	All		300		μS
Output Current	xxD12	0		±1250	mA
	xxD15	0		±1000	
Output Over Voltage Protection (Zener diode clamp)	xxD12		15		V <sub>DC</sub>
	xxD15		18		
Output Over Current Protection	All			150	% FL.
Output Short Circuit Protection	All	Hiccup, automatic recovery			

Input Specification					
Parameter	Model	Min	Typ	Max	Unit
Operating Input Voltage	12Dxx	9	12	18	$V_{DC}$
	24Dxx	18	24	36	
	48Dxx	36	48	75	
Input Current (Maximum value at $V_{in} = V_{in(nom)}$ ; Full Load)	12D12			3012	mA
	12D15			3012	
	24D12			1488	
	24D15			1488	
	48D12			744	
	48D15			744	
Input Standby Current (Typical value at $V_{in} = V_{in(nom)}$ ; No Load)	12D12		60		mA
	12D15		40		
	24D12		30		
	24D15		30		
	48D12		20		
	48D15		20		
Under Voltage Lockout Turn-on Threshold	12Dxx			9	$V_{DC}$
	24Dxx			17.8	
	48Dxx			36	
Under Voltage Lockout Turn-off Threshold	12Dxx		8		$V_{DC}$
	24Dxx		16		
	48Dxx		33		
Input Reflected Ripple Current (5 to 20MHz, 12 $\mu$ H Source Impedance)	All		30		mAp-p
Start Up Time ( $V_{in} = V_{in(nom)}$ and Constant Resistive Load)					mS
	Power Up	All		25	
	Remote ON/OFF			25	
Remote ON/OFF Control (The ON/OFF pin voltage is referenced to $-V_{IN}$ )					$V_{DC}$
	Positive Logic DC-DC ON	All	3.0	12	
	DC-DC OFF		0	1.2	
Remote Off Input Current	All		2.5		mA
Input Current of Remote Control Pin	All	-0.5		0.5	mA

General Specification					
Parameter	Model	Min	Typ	Max	Unit
Efficiency ( $V_{in} = V_{in(nom)}$ ; Full Load ; $T_A=25^{\circ}C$ )	12D12		87		%
	12D15		87		
	24D12		88		
	24D15		88		
	48D12		88		
	48D15		88		
Isolation Voltage Input to Output Input to Case, Output to Case	All	1600 1600			$V_{DC}$
Isolation Resistance	All	1			$G\Omega$
Isolation Capacitance	All			1000	pF
Switching Frequency	All		300		kHz
Weight	All		48		g
MTBF Bellcore TR-NWT-000332, $T_C=40^{\circ}C$ MIL-HDBK-217F	All		$1.316 \times 10^6$ $3.465 \times 10^5$		hours
Over Temperature Protection	All		115		$^{\circ}C$

Characteristic Curves

All test conditions are at 25°C. The figures are for PXE30-12D12

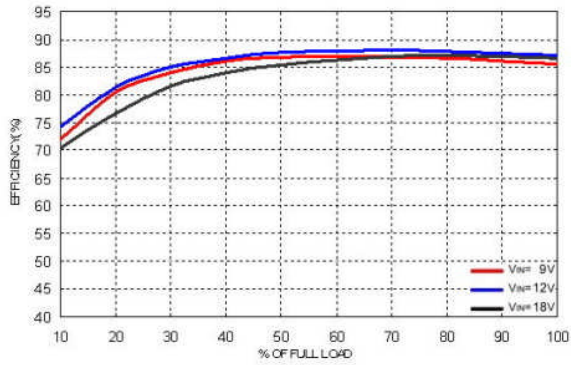

Efficiency Versus Output Current

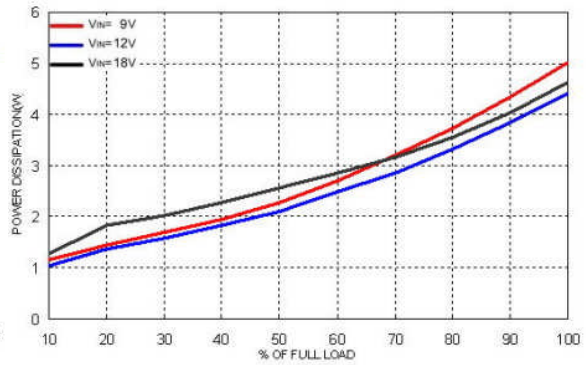

Power Dissipation Versus Output Current

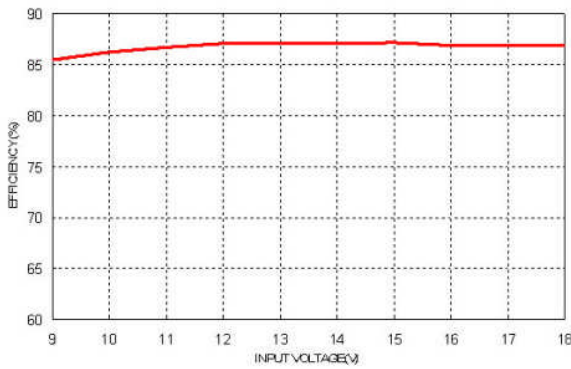

Efficiency Versus Input Voltage. Full Load

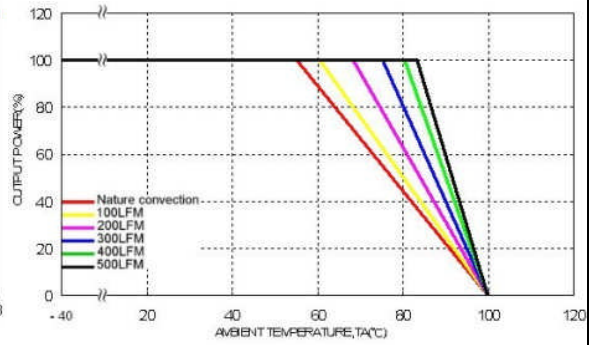

Derating Output Current Versus Ambient Temperature and Airflow  $V_{in} = V_{in}(nom)$

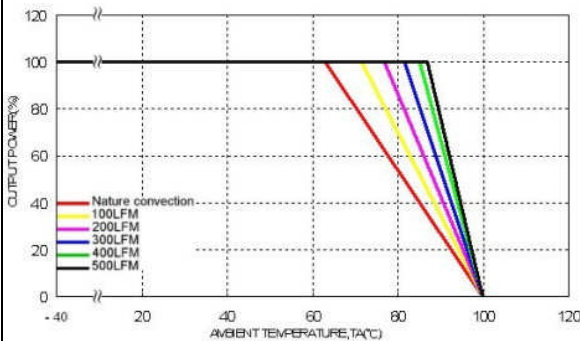

Derating Output Current Versus Ambient Temperature with Heat-Sink and Airflow,  $V_{in} = V_{in}(nom)$

Characteristic Curves (Continued)

All test conditions are at 25°C. The figures are for PXE30-12D12

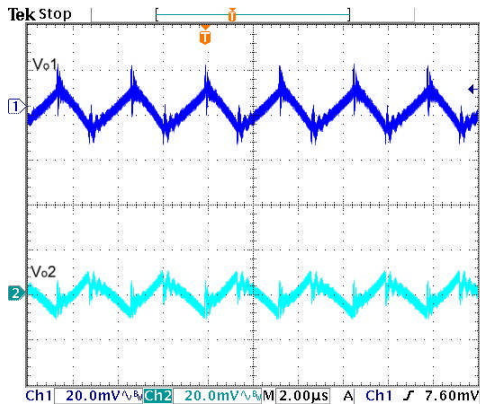

Typical Output Ripple and Noise.  
Vin=Vin(nom), Full Load

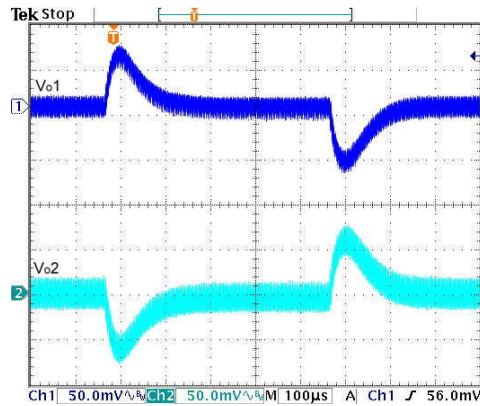

Transient Response to Dynamic Load Change from 100% to 75% to 100% of Full Load ; Vin=Vin(nom)

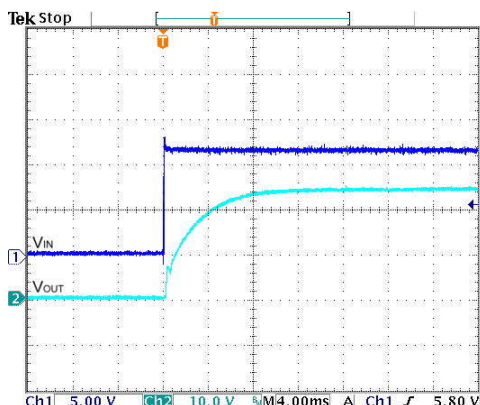

Typical Input Start-Up and Output Rise Characteristic  
Vin=Vin(nom), Full Load

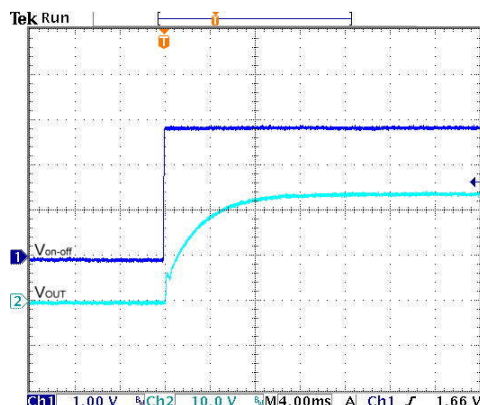

Using ON/OFF Voltage Start-Up and Vo Rise Characteristic  
Vin=Vin(nom), Full Load

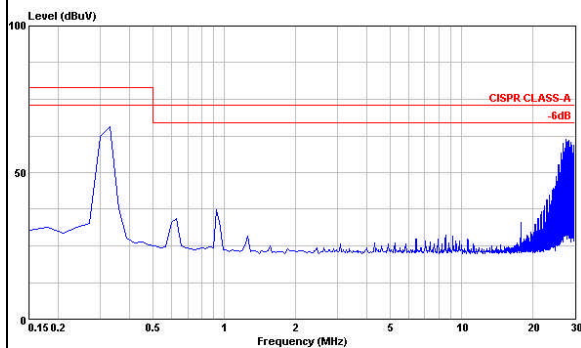

Conduction Emission of EN55022 Class A  
Vin=Vin(nom), Full Load

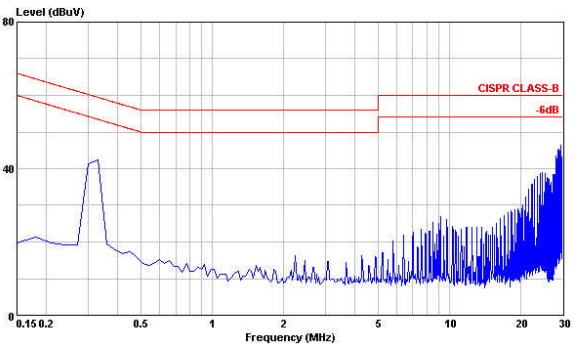

Conduction Emission of EN55022 Class B  
Vin=Vin(nom), Full Load

Characteristic Curves (Continued)

All test conditions are at 25°C. The figures are for PXE30-12D15

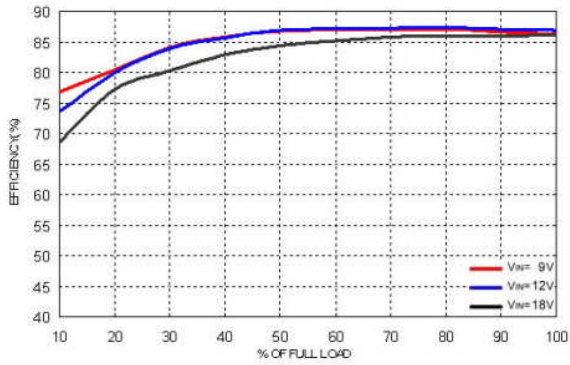

Efficiency Versus Output Current

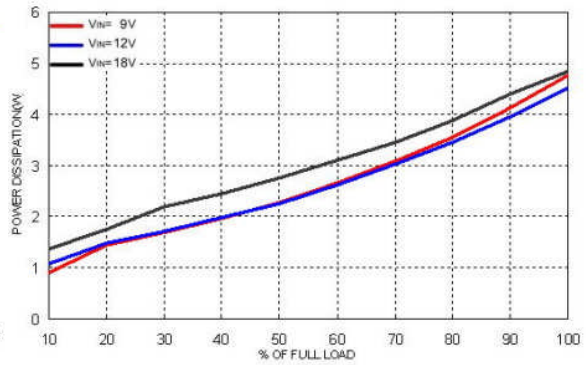

Power Dissipation Versus Output Current

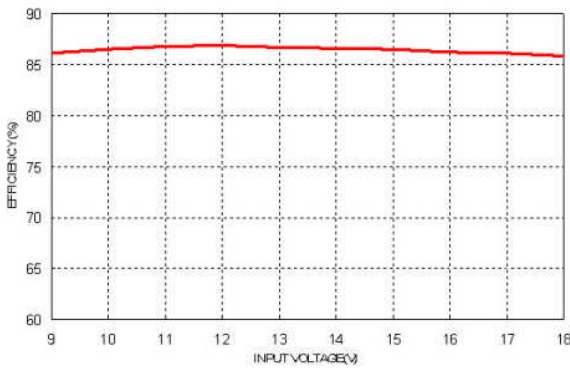

Efficiency Versus Input Voltage. Full Load

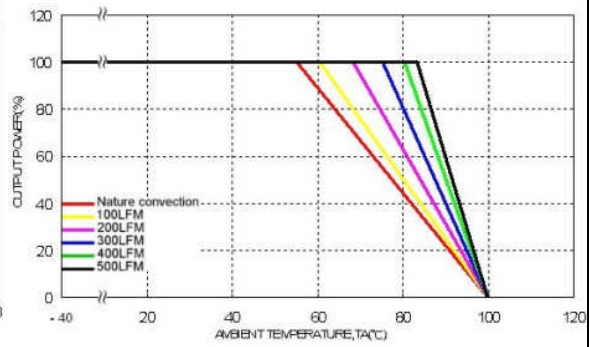

Derating Output Current Versus Ambient Temperature and Airflow Vin=Vin(nom)

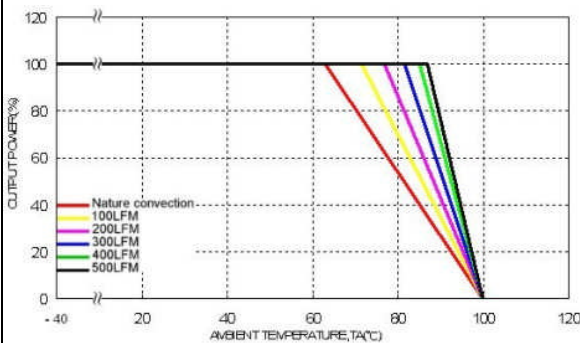

Derating Output Current Versus Ambient Temperature with Heat-Sink and Airflow, Vin = Vin(nom)

Characteristic Curves (Continued)

All test conditions are at 25°C. The figures are for PXE30-12D15

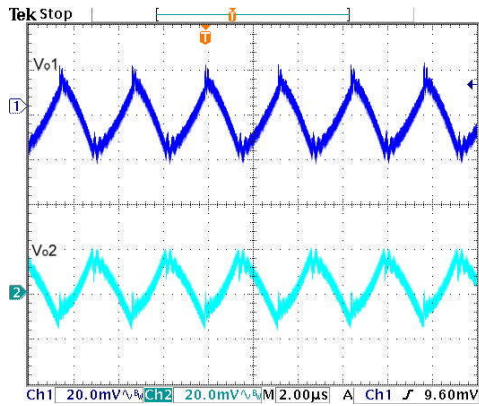

Typical Output Ripple and Noise.  
Vin=Vin(nom), Full Load

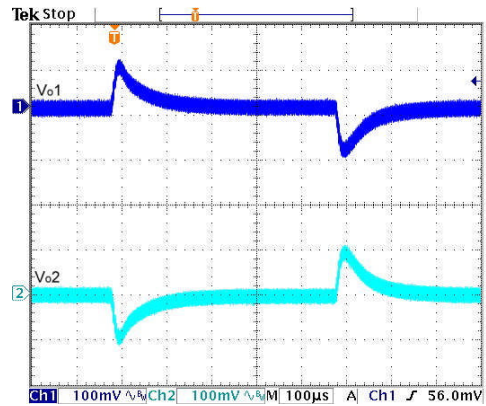

Transient Response to Dynamic Load Change from  
100% to 75% to 100% of Full Load ; Vin=Vin(nom)

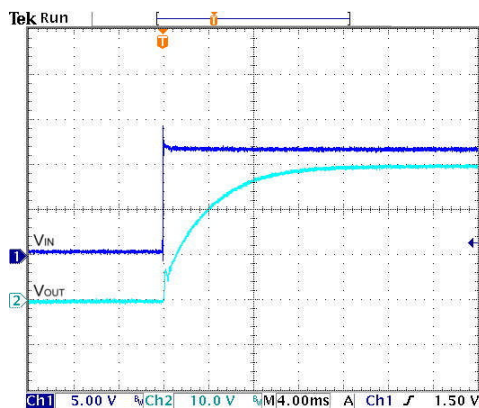

Typical Input Start-Up and Output Rise Characteristic  
Vin=Vin(nom), Full Load

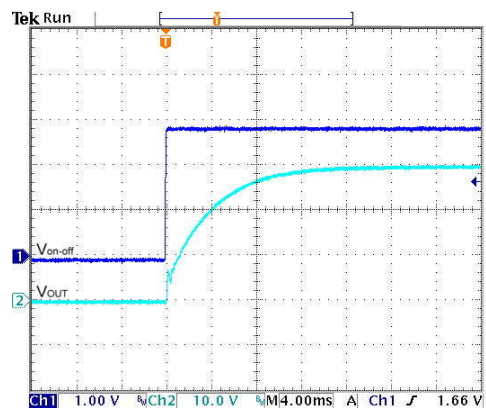

Using ON/OFF Voltage Start-Up and Vo Rise Characteristic  
Vin=Vin(nom), Full Load

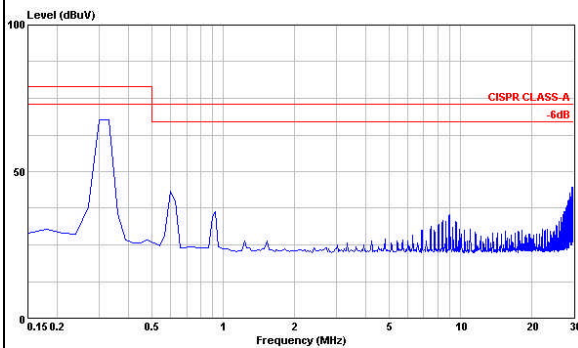

Conduction Emission of EN55022 Class A  
Vin=Vin(nom), Full Load

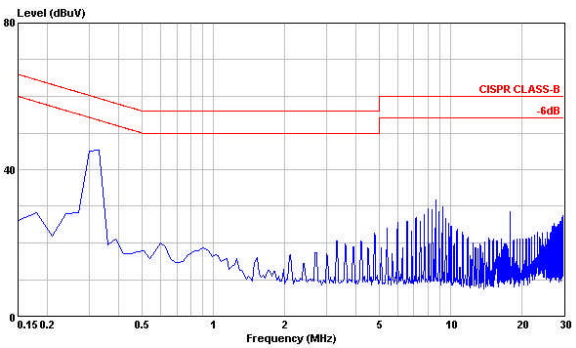

Conduction Emission of EN55022 Class B  
Vin=Vin(nom), Full Load



Characteristic Curves (Continued)

All test conditions are at 25°C. The figures are for PXE30-24D12

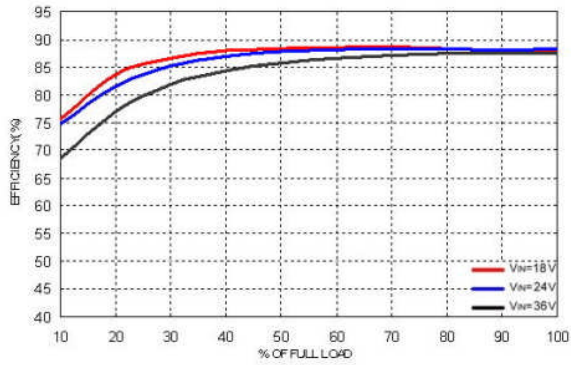

Efficiency Versus Output Current

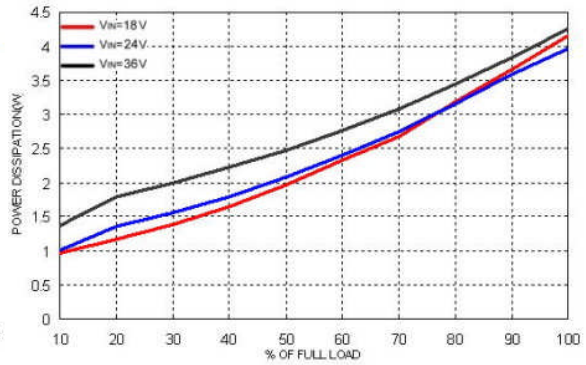

Power Dissipation Versus Output Current

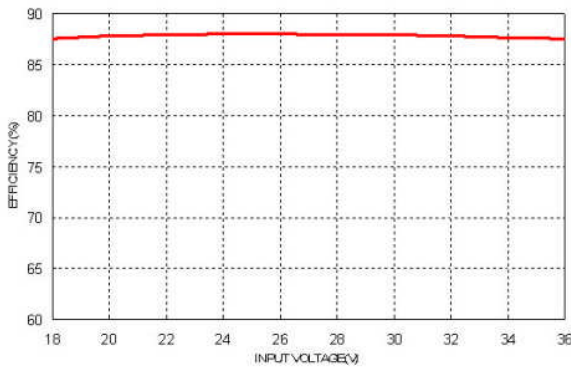

Efficiency Versus Input Voltage. Full Load

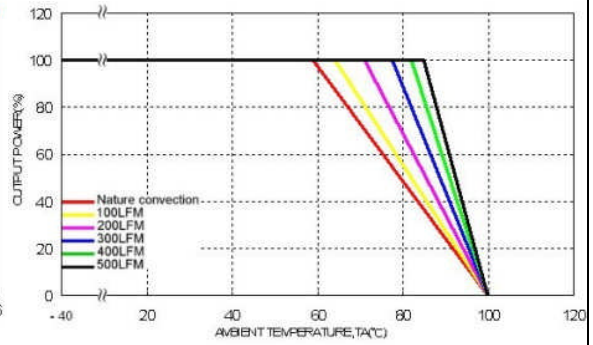

Derating Output Current Versus Ambient Temperature and Airflow Vin=Vin(nom)

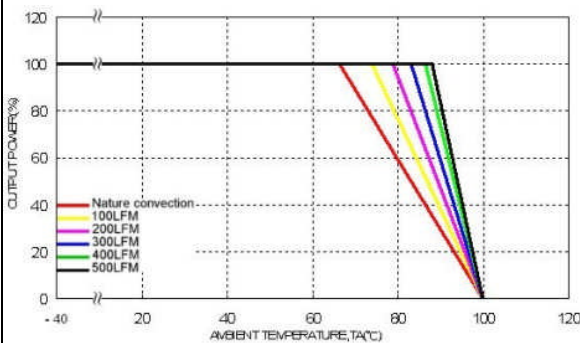

Derating Output Current Versus Ambient Temperature with Heat-Sink and Airflow, Vin = Vin(nom)

Characteristic Curves (Continued)

All test conditions are at 25°C. The figures are for PXE30-24D12

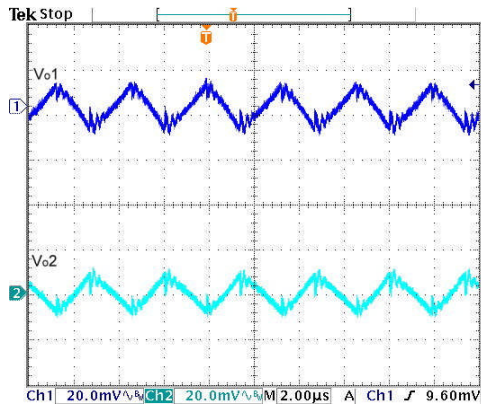

**Typical Output Ripple and Noise.**  
 Vin=Vin(nom), Full Load

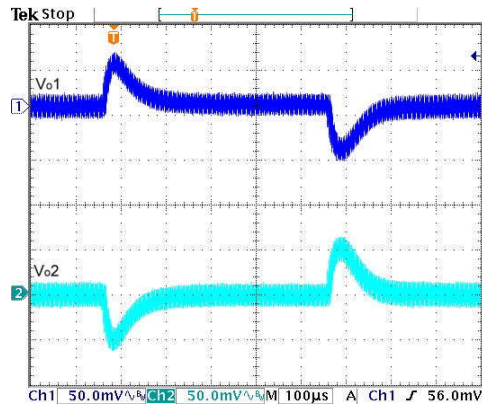

**Transient Response to Dynamic Load Change from 100% to 75% to 100% of Full Load ; Vin=Vin(nom)**

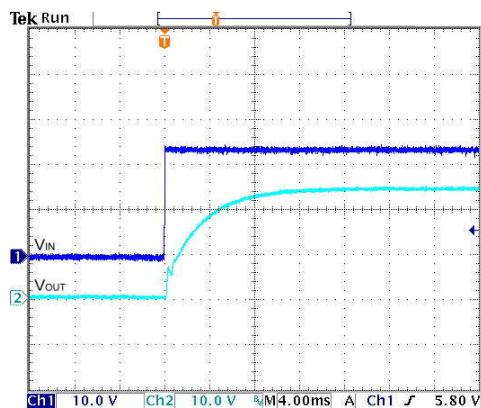

**Typical Input Start-Up and Output Rise Characteristic**  
 Vin=Vin(nom), Full Load

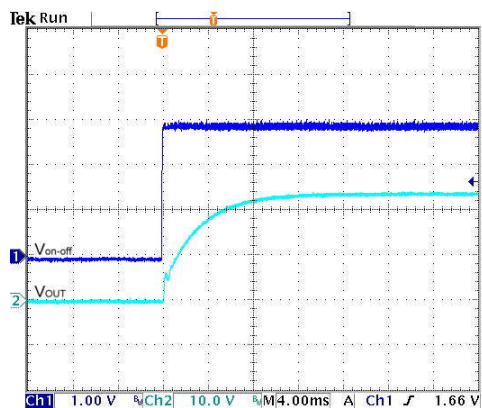

**Using ON/OFF Voltage Start-Up and Vo Rise Characteristic**  
 Vin=Vin(nom), Full Load

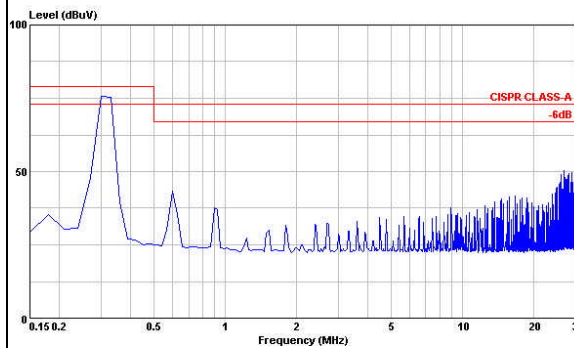

**Conduction Emission of EN55022 Class A**  
 Vin=Vin(nom), Full Load

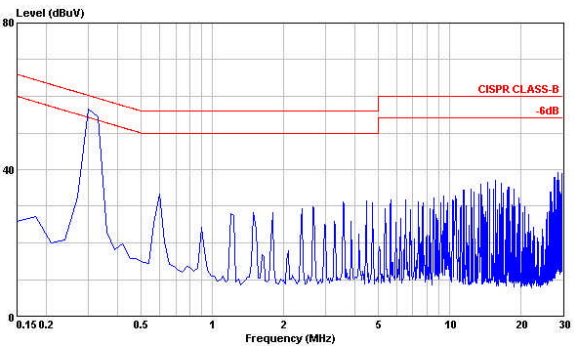

**Conduction Emission of EN55022 Class B**  
 Vin=Vin(nom), Full Load

Characteristic Curves (Continued)

All test conditions are at 25°C. The figures are for PXE30-24D15

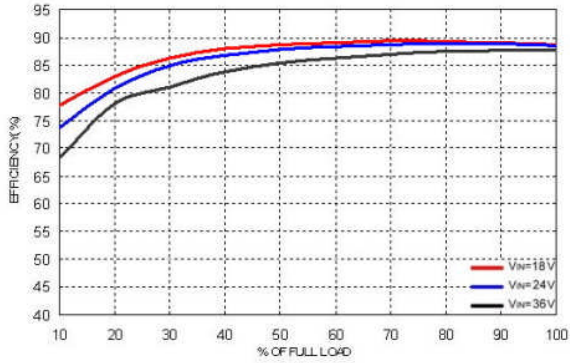

Efficiency Versus Output Current

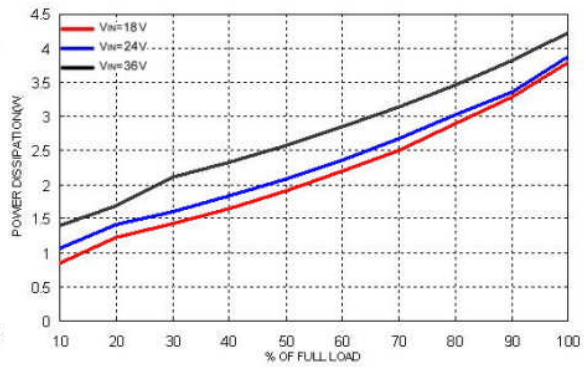

Power Dissipation Versus Output Current

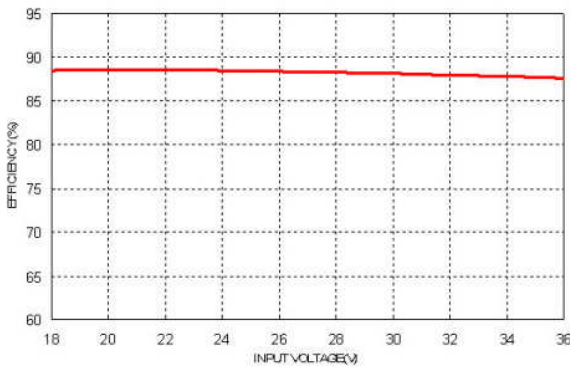

Efficiency Versus Input Voltage. Full Load

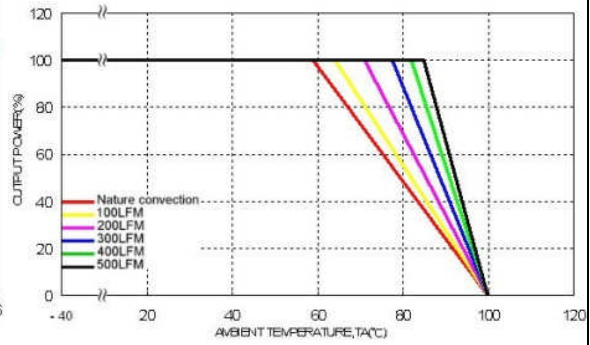

Derating Output Current Versus Ambient Temperature and Airflow Vin=Vin(nom)

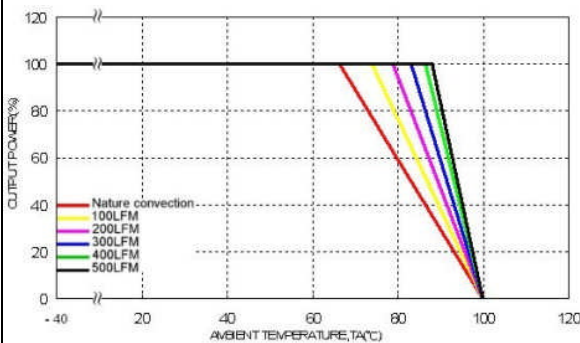

Derating Output Current Versus Ambient Temperature with Heat-Sink and Airflow, Vin = Vin(nom)

Characteristic Curves (Continued)

All test conditions are at 25°C. The figures are for PXE30-24D15

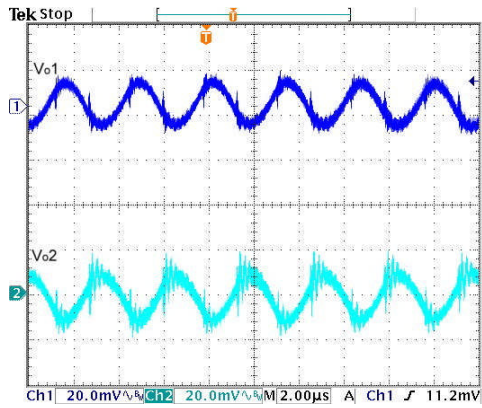

Typical Output Ripple and Noise.  
Vin=Vin(nom), Full Load

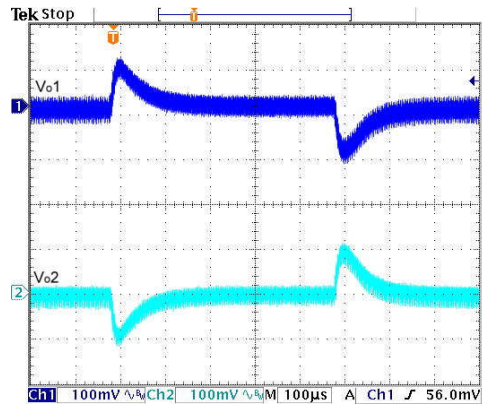

Transient Response to Dynamic Load Change from 100% to 75% to 100% of Full Load ; Vin=Vin(nom)

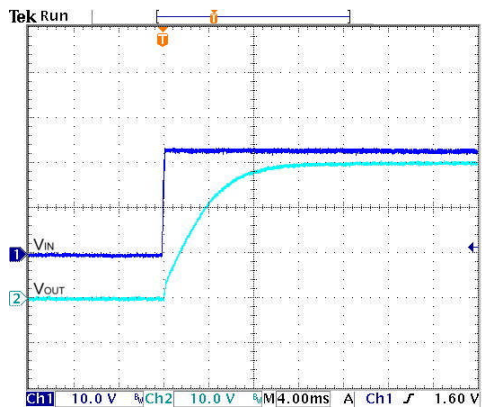

Typical Input Start-Up and Output Rise Characteristic  
Vin=Vin(nom), Full Load

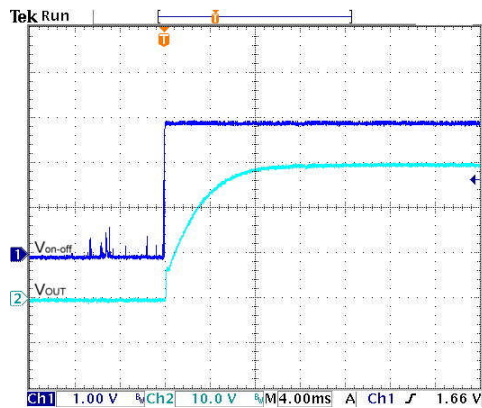

Using ON/OFF Voltage Start-Up and Vo Rise Characteristic  
Vin=Vin(nom), Full Load

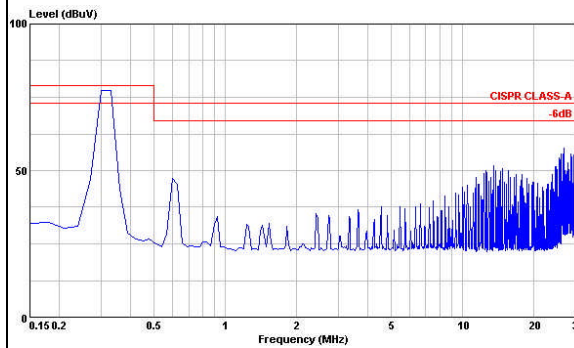

Conduction Emission of EN55022 Class A  
Vin=Vin(nom), Full Load

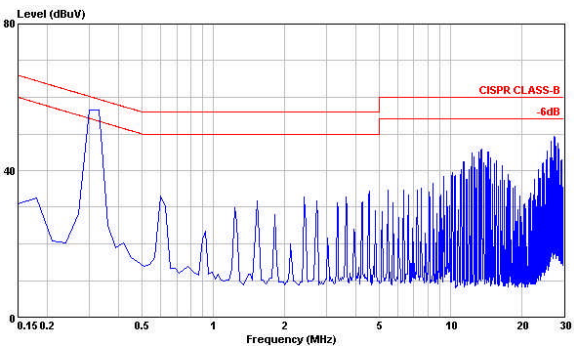

Conduction Emission of EN55022 Class B  
Vin=Vin(nom), Full Load

Characteristic Curves (Continued)

All test conditions are at 25°C. The figures are for PXE30-48D12

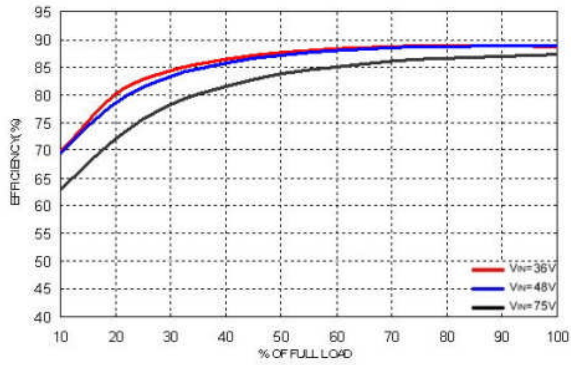

Efficiency Versus Output Current

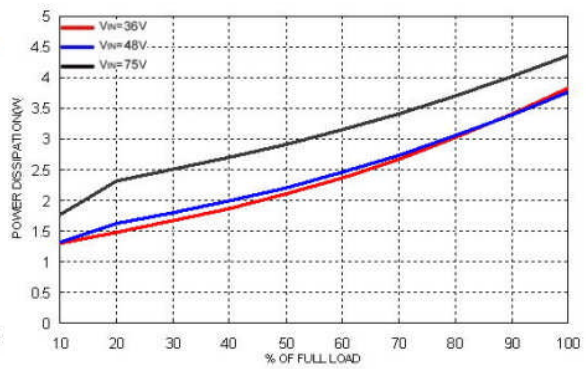

Power Dissipation Versus Output Current

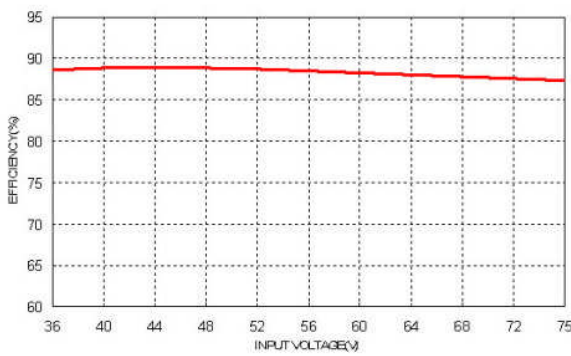

Efficiency Versus Input Voltage. Full Load

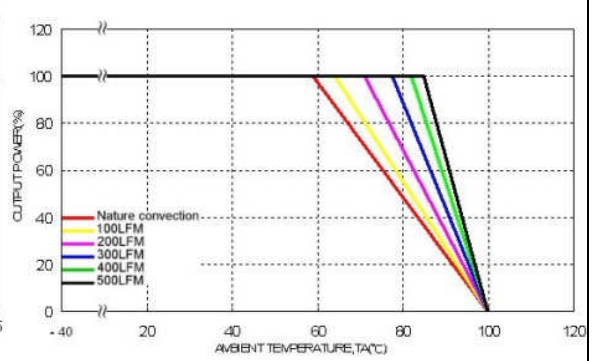

Derating Output Current Versus Ambient Temperature and Airflow Vin=Vin(nom)

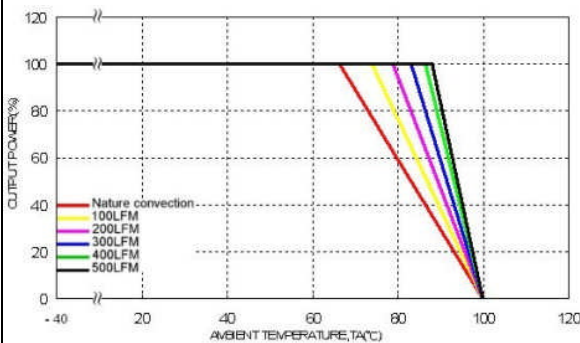

Derating Output Current Versus Ambient Temperature with Heat-Sink and Airflow, Vin = Vin(nom)

Characteristic Curves (Continued)

All test conditions are at 25°C. The figures are for PXE30-48D12

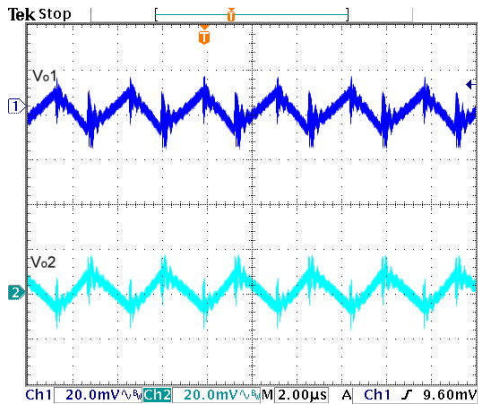

Typical Output Ripple and Noise.  
Vin=Vin(nom), Full Load

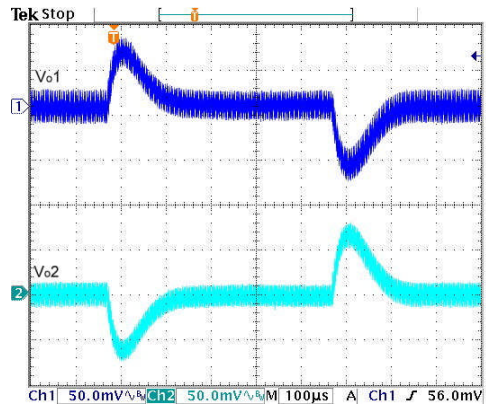

Transient Response to Dynamic Load Change from 100% to 75% to 100% of Full Load ; Vin=Vin(nom)

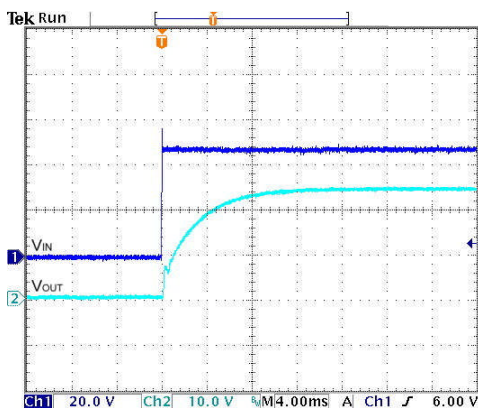

Typical Input Start-Up and Output Rise Characteristic  
Vin=Vin(nom), Full Load

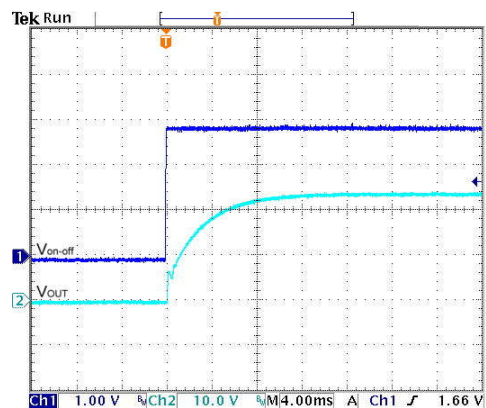

Using ON/OFF Voltage Start-Up and Vo Rise Characteristic  
Vin=Vin(nom), Full Load

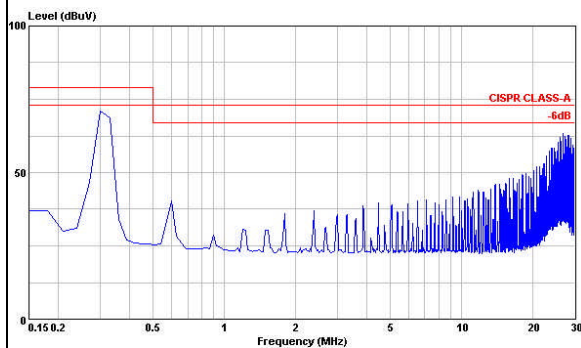

Conduction Emission of EN55022 Class A  
Vin=Vin(nom), Full Load

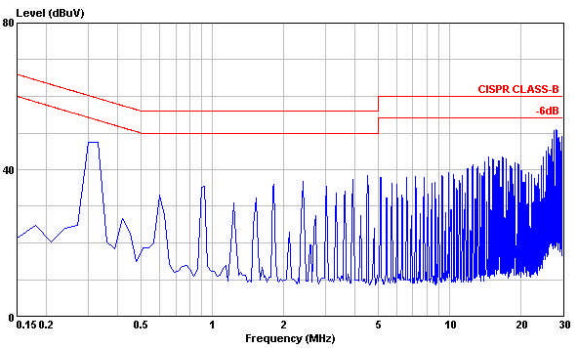

Conduction Emission of EN55022 Class B  
Vin=Vin(nom), Full Load

Characteristic Curves (Continued)

All test conditions are at 25°C. The figures are for PXE30-48D15

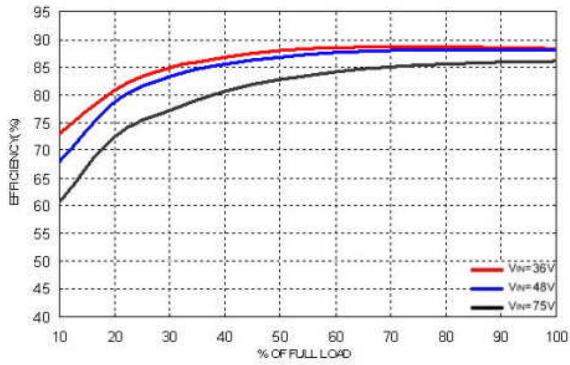

Efficiency Versus Output Current

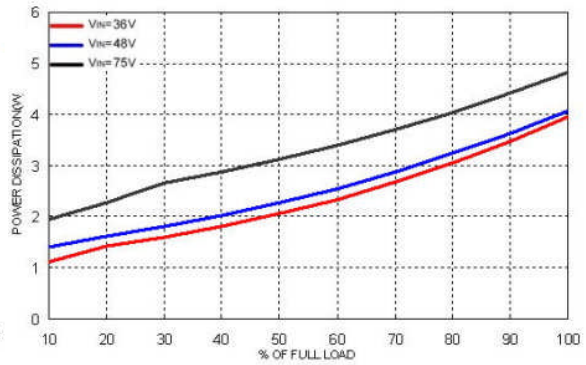

Power Dissipation Versus Output Current

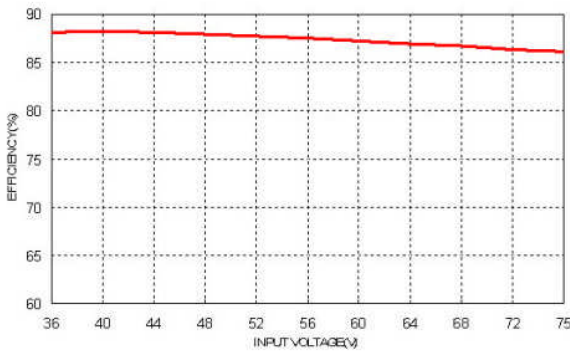

Efficiency Versus Input Voltage. Full Load

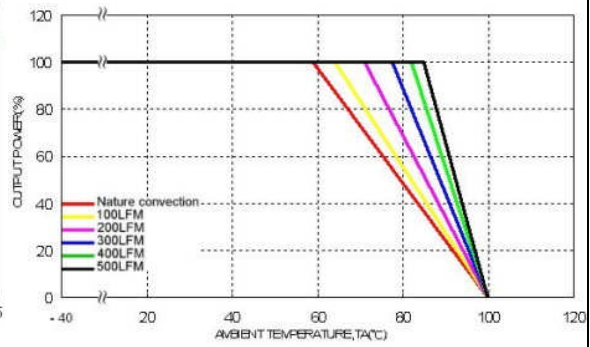

Derating Output Current Versus Ambient Temperature and Airflow Vin=Vin(nom)

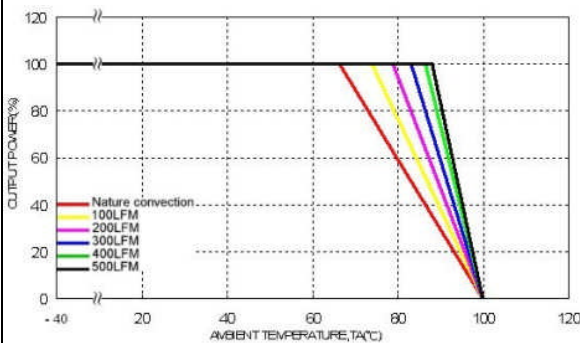

Derating Output Current Versus Ambient Temperature with Heat-Sink and Airflow, Vin = Vin(nom)

Characteristic Curves (Continued)

All test conditions are at 25°C. The figures are for PXE30-48D15

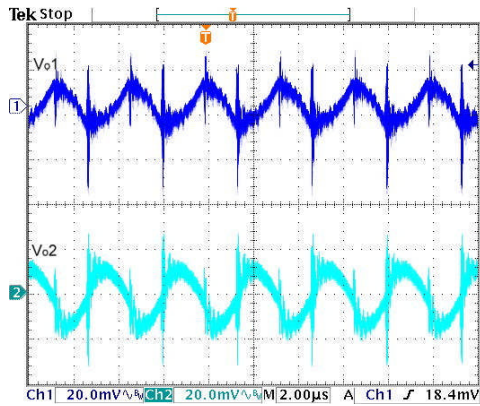

Typical Output Ripple and Noise.  
Vin=Vin(nom), Full Load

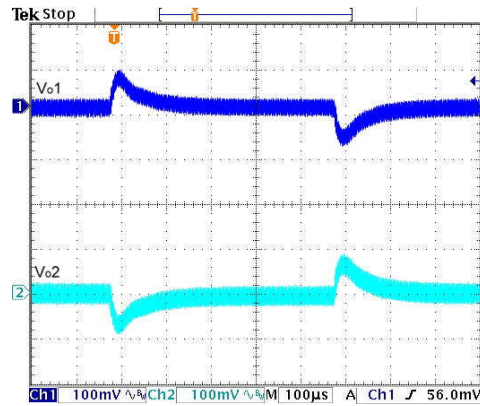

Transient Response to Dynamic Load Change from 100% to 75% to 100% of Full Load ; Vin=Vin(nom)

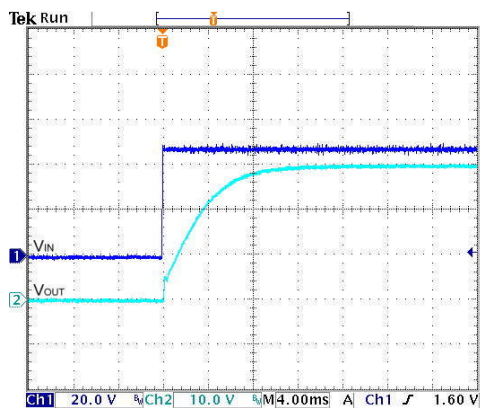

Typical Input Start-Up and Output Rise Characteristic  
Vin=Vin(nom), Full Load

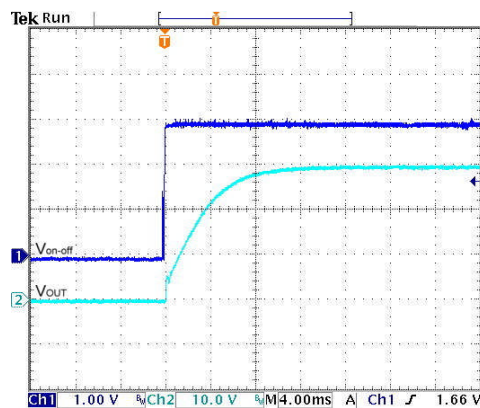

Using ON/OFF Voltage Start-Up and Vo Rise Characteristic  
Vin=Vin(nom), Full Load

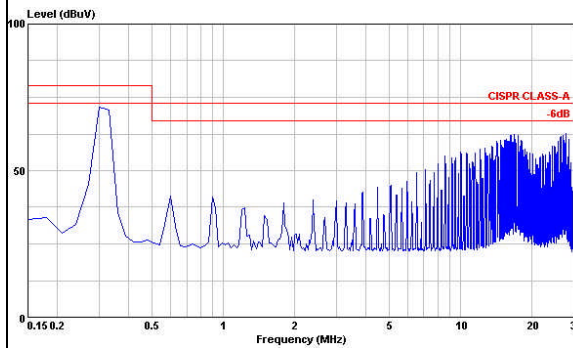

Conduction Emission of EN55022 Class A  
Vin=Vin(nom), Full Load

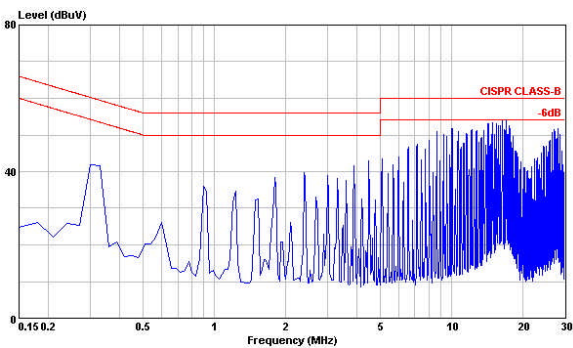

Conduction Emission of EN55022 Class B  
Vin=Vin(nom), Full Load



Test Configurations

Input reflected-ripple current measurement test:

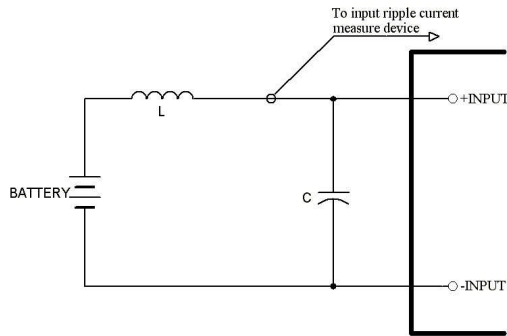

Component	Value	Voltage	Reference
L	12μH	---	---
C	220μF	100V	Aluminum Electrolytic Capacitor

Peak-to-peak output ripple & noise measurement test:

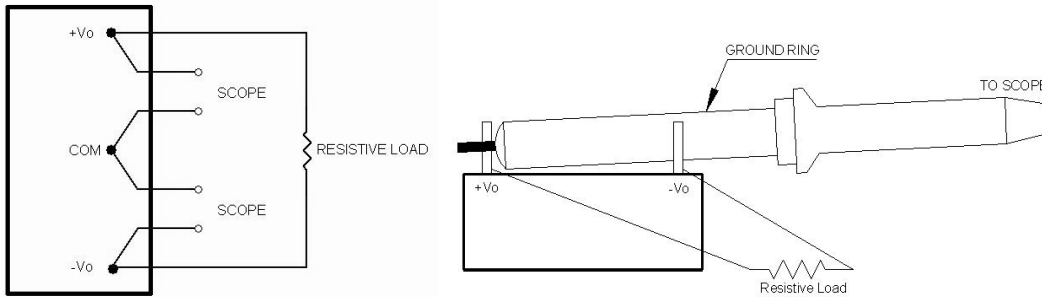

Output voltage and efficiency measurement test:

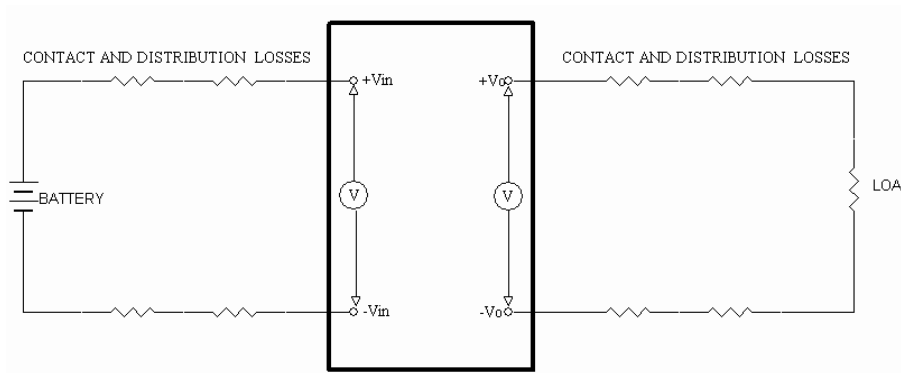

Note: All measurements are taken at the module terminals.

$$Efficiency = \left( \frac{V_o \times I_o}{V_{in} \times I_{in}} \right) \times 100\%$$

EMC Considerations

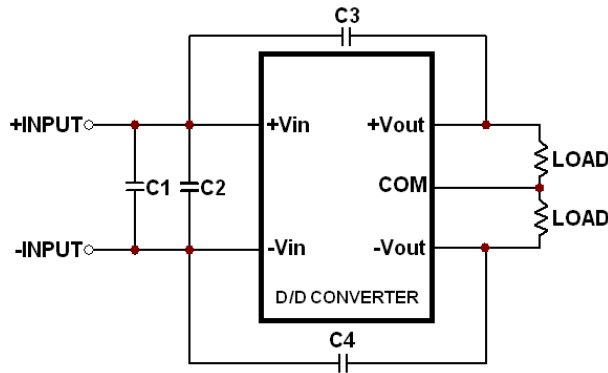

Suggested Schematic for EN55022 Conducted Emission Class A Limits

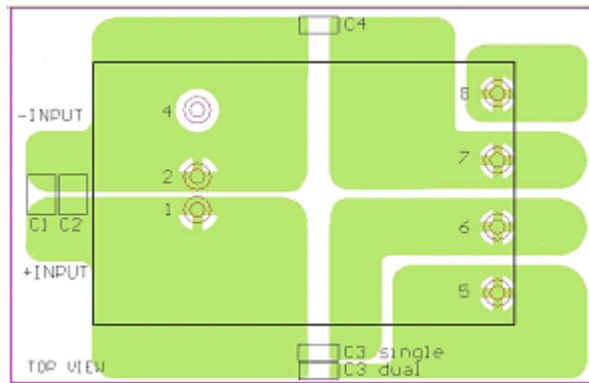

Recommended Layout with Input Filter

To meet conducted emissions EN 55022 CLASS A the following components are needed:

PXE30-12Dxx

Component	Value	Voltage	Reference
C1	6.8 $\mu$ F	50V	1812 MLCC
C3、C4	1000pF	2KV	1808 MLCC

PXE30-24Dxx

Component	Value	Voltage	Reference
C1	6.8 $\mu$ F	50V	1812 MLCC
C3:C4	1000pF	2KV	1808 MLCC

PXE30-48Dxx

Component	Value	Voltage	Reference
C1	2.2 $\mu$ F	100V	1812 MLCC
C3:C4	1000pF	2KV	1808 MLCC

EMC Considerations (Continued)

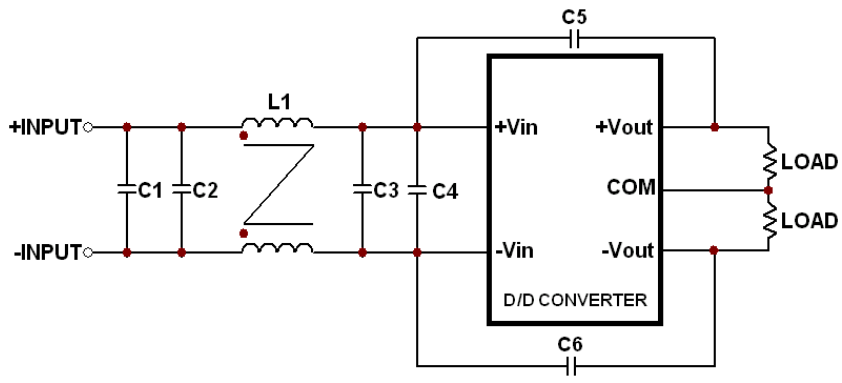

Suggested Schematic for EN55022 Conducted Emission Class B Limits

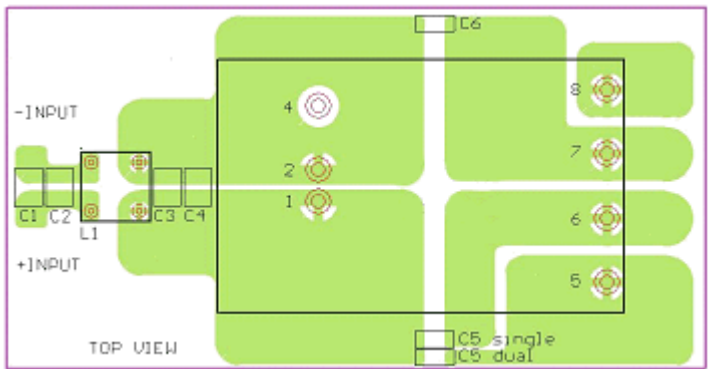

Recommended Layout with Input Filter

To meet conducted emissions EN55022 CLASS B needed the following components :

PXE30-12Dxx

Component	Value	Voltage	Reference
C1:C3	4.7 $\mu$ F	50V	1812 MLCC
C5:C6	1000pF	2KV	1808 MLCC
L1	450 $\mu$ H	----	Common Choke

PXE30-24Dxx

Component	Value	Voltage	Reference
C1:C3	6.8 $\mu$ F	50V	1812 MLCC
C5:C6	1000pF	2KV	1808 MLCC
L1	450 $\mu$ H	----	Common Choke

PXE30-48Dxx

Component	Value	Voltage	Reference
C1:C2	2.2 $\mu$ F	100V	1812 MLCC
C3:C4	2.2 $\mu$ F	100V	1812 MLCC
C5:C6	1000pF	2KV	1808 MLCC
L1	450 $\mu$ H	----	Common Choke

## EMC Considerations (Continued)

This Common Choke L1 is defined as follows:

■ PMT-048

L:450 $\mu$ H $\pm$ 35% / DCR:25m $\Omega$ , max

A height:9.8 mm, Max

■ All dimensions in millimeters

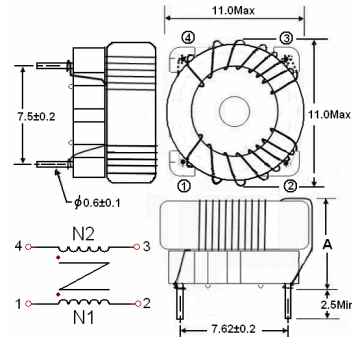

## Input Source Impedance

The power module should be connected to a low impedance input source. Highly inductive source impedance can affect the stability of the power module. Input external L-C filter is recommended to minimize input reflected ripple current. The inductor has a simulated source impedance of 12 $\mu$ H and capacitor is Nippon chemi-con KY series 220 $\mu$ F/100V. The capacitor must as close as possible to the input terminals of the power module for lower impedance.

## Output Over Current Protection

When excessive output currents occur in the system, circuit protection is required on all converters. Normally, overload current is maintained at approximately 150 percent of rated current for PXF40-xxSxx series.

Hiccup-mode is a method of operation in a converter whose purpose is to protect the power supply from being damaged during an over-current fault condition. It also enables the converter to restart when the fault is removed. There are other ways of protecting the converter when it is over-loaded, such as the maximum current limiting or current foldback methods.

One of the problems resulting from over current is that excessive heat may be generated in power devices; especially MOSFET and Schottky diodes and the temperature of these devices may exceed their specified limits. A protection mechanism has to be used to prevent these power devices from being damaged.

The operation of hiccup is as follows. When the current sense circuit sees an over-current event, the controller shuts off the converter for a given time and then tries to start up the converter again. If the over-load condition has been removed, the converter will start up and operate normally; otherwise, the controller will see another over-current event and will shut off the converter again, repeating the previous cycle. Hiccup operation has none of the drawbacks of the other two protection methods, although its circuit is more complicated because it requires a timing circuit. The excess heat due to overload lasts for only a short duration in the hiccup cycle, hence the junction temperature of the power devices is much lower.

### Output Over Voltage Protection

The output over-voltage protection consists of a Zener diode that monitors the voltage on the output terminals. If the voltage on the output terminals exceeds the over-voltage protection threshold, then the Zener diode clamps the output voltage.

### Short Circuit Protection

Continuous, hiccup and auto-recovery mode.

During a short circuit, the converter shut s down. The average current during this condition will be very low .

### Thermal Consideration

The power module operates in a variety of thermal environments. However, sufficient cooling should be provided to help ensure reliable operation of the unit. Heat is removed by conduction, convection, and radiation to the surrounding environment. Proper cooling can be verified by measuring the point as shown in the figure below. The temperature at this location should not exceed 100°C. When operating, adequate cooling must be provided to maintain the test point temperature at or below 100°C. Although the maximum point temperature of the power modules is 100°C, limiting this temperature to a lower value will yield higher reliability.

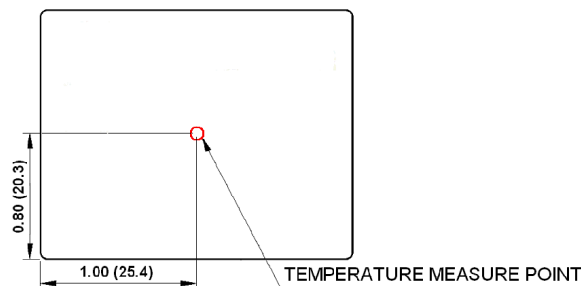

### Heat Sink Consideration

Use heat-sink (7G-0011C-F) for lowering temperature and higher reliability of the module.

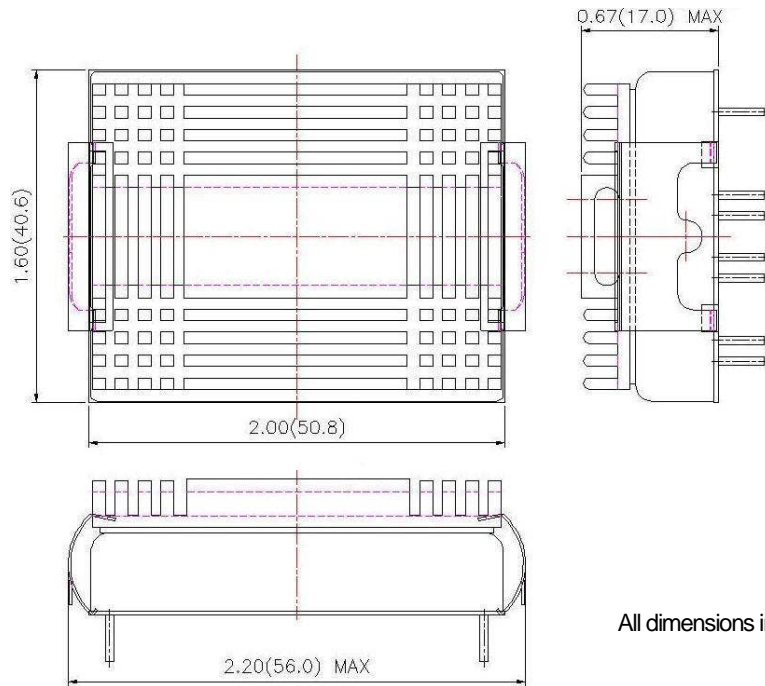

All dimensions in millimeters

Remote ON/OFF Control

The Remote ON/OFF Pin is used to turn on and off the DC/DC power module. The user must use a switch to control the logic voltage (high or low level ) of the pin referenced to -Vin. The switch can be an open collector transistor, FET and Opto-Coupler. The switch must be capable of sinking up to 0.5 mA at low-level logic voltage. High-level logic of the ON/OFF signal (maximum voltage): the allowable leakage current of the switch at 12V is 0.5mA.

Remote ON/OFF Implementation Circuits

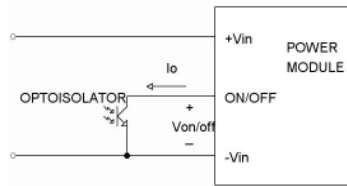

Isolated-Control Remote ON/OFF

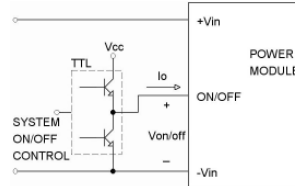

Level Control Using TTL Output

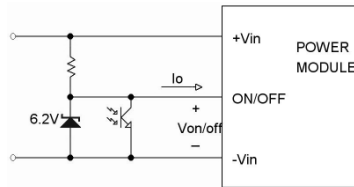

Level Control Using Line Voltage

Positive Logic:

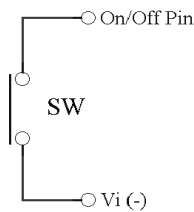

When PXE30 module is turned off at Low-level logic

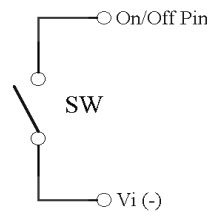

When PXE30 module is turned on at High-level logic

Mechanical Data

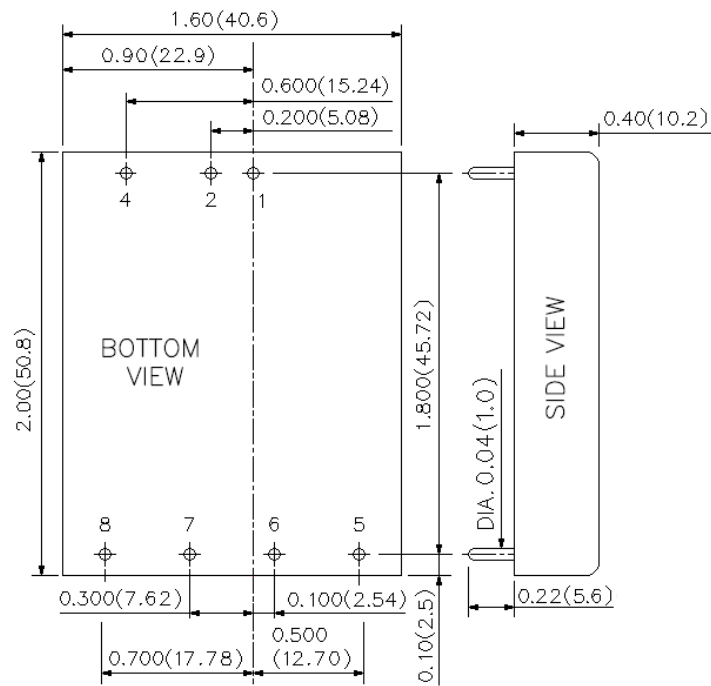

PIN CONNECTION	
PIN	FUNCTION
1	+INPUT
2	-INPUT
4	CTRL
5	+OUTPUT
6	COMMON
7	-OUTPUT
8	TRIM

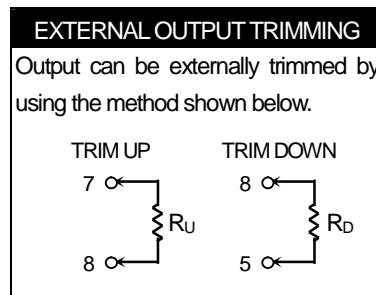



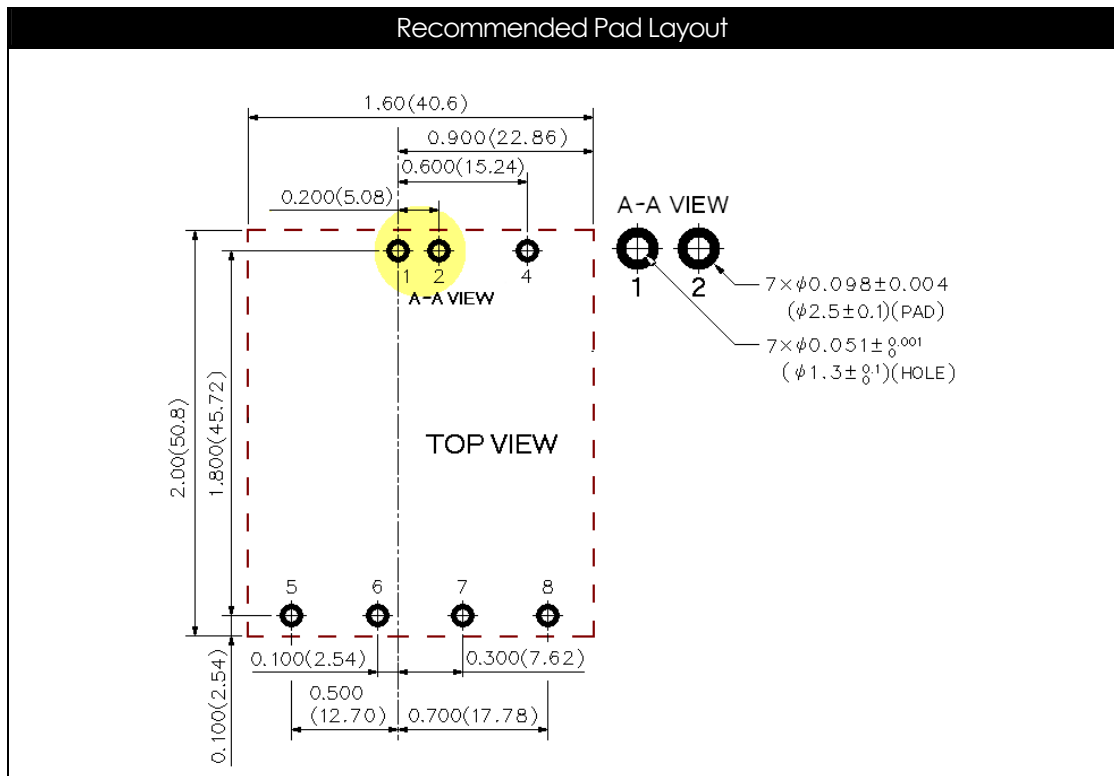

## Output Voltage Adjustment

Output voltage set point adjustment allows the user to increase or decrease the output voltage set point of a module. This is accomplished by connecting an external resistor between the TRIM pin and either the Vo(+) or Vo(-) pins. With an external resistor between the TRIM and Vo(-) pin, the output voltage set point increases. With an external resistor between the TRIM and Vo(+) pin, the output voltage set point decreases.

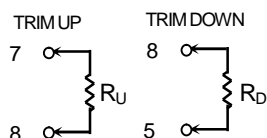

## TRIM TABLE

PXE30-xxD12

Trim up (%)	1	2	3	4	5	6	7	8	9	10
V <sub>out</sub> (Volts)=	±12.12	±12.24	±12.36	±12.48	±12.6	±12.72	±12.84	±12.96	±13.08	±13.2
R <sub>U</sub> (K OhmS)=	218.21	98.105	58.07	38.052	26.042	18.035	12.316	8.026	4.69	2.021
Trim down (%)	1	2	3	4	5	6	7	8	9	10
V <sub>out</sub> (Volts)=	±11.88	±11.76	±11.64	±11.52	±11.4	±11.28	±11.16	±11.04	±10.92	±10.8
R <sub>D</sub> (K OhmS)=	273.44	123.02	72.874	47.803	32.76	22.732	15.568	10.196	6.017	2.675

PXE30-xxD15

Trim up (%)	1	2	3	4	5	6	7	8	9	10
V <sub>out</sub> (Volts)=	±15.15	±15.3	±15.45	±15.6	±15.75	±15.9	±16.05	±16.2	±16.35	±16.5
R <sub>U</sub> (K OhmS)=	268.29	120.64	71.429	46.822	32.058	22.215	15.184	9.911	5.81	2.529
Trim down (%)	1	2	3	4	5	6	7	8	9	10
V <sub>out</sub> (Volts)=	±14.85	±14.7	±14.55	±14.4	±14.25	±14.1	±13.95	±13.8	±13.65	±13.5
R <sub>D</sub> (K OhmS)=	337.71	152.02	90.126	59.178	40.609	28.23	19.387	12.756	7.598	3.471

Soldering and Reflow Consideration

Lead free wave solder profile for PXE30-xxDxx DIP type

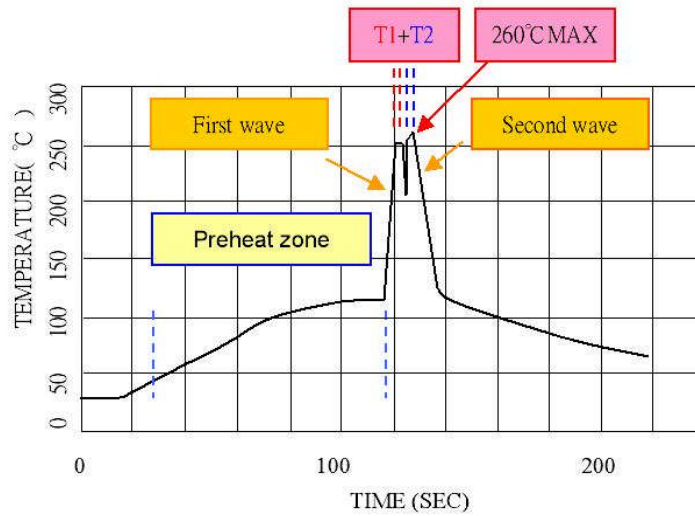

Zone	Reference Parameter
Preheat zone	Rise temp. speed : 3°C / sec max. Preheat temp. : 100~130°C
Actual heating	Peak temp. : 250~260°C Peak time (T1+T2 time) : 4~6 sec

**Reference Solder:**Sn-Ag-Cu/Sn-Cu

**Hand Welding:**Soldering iron-Power 90W

Welding Time:2-4 sec

Temp.:380-400 °C

Packaging Information

12 PCS per TUBE

**Part Number Structure**

**PXE 30 - 24 D 15**

**Max. Output Power**  
30Watts

**Input Voltage Range**  
12 : 9 ~ 18V  
24 : 18 ~ 36V  
48 : 36 ~ 75V

**Dual Output**

**Output Voltage**

12	: 12Vdc
15	: 15Vdc

Model Number	Input Range	Output Voltage	Output Current		Input Current		Eff <sup>(3)</sup> (%)
			Min. load	Full Load	No load <sup>(1)</sup>	Full Load <sup>(2)</sup>	
PXE30-12D12	9 – 18 VDC	12 VDC	0mA	1250mA	60mA	3012mA	87
PXE30-12D15	9 – 18 VDC	15 VDC	0mA	1000mA	40mA	3012mA	87
PXE30-24D12	18 – 36 VDC	12 VDC	0mA	1250mA	50mA	1488mA	88
PXE30-24D15	18 – 36 VDC	15 VDC	0mA	1000mA	35mA	1488mA	88
PXE30-48D12	36 – 75 VDC	12 VDC	0mA	1250mA	45mA	744mA	88
PXE30-48D15	36 – 75 VDC	15 VDC	0mA	1000mA	50mA	744mA	88

Note 1. Typical value at nominal input voltage and no load.  
 Note 2. Maximum value at nominal input voltage and full load.  
 Note 3. Typical value at nominal input voltage and full load.

**Safety and Installation Instruction**

**Fusing Consideration**

Caution: This power module is not internally fused. An input line fuse must always be used.

This encapsulated power module can be used in a wide variety of applications, ranging from simple stand-alone operation to an integrated part of sophisticated power architecture. For maximum flexibility, internal fusing is not included; however, to achieve maximum safety and system protection, always use an input line fuse. The safety agencies require a slow-blow fuse with maximum rating of 6A. Based on the information provided in this data sheet on Inrush energy and maximum DC input current; the same type of fuse with lower rating can be used. Refer to the fuse manufacturer's data for further information.

**MTBF and Reliability**

**The MTBF of PXE30-xxDxx DC/DC converters has been calculated using:**

Bellcore TR-NWT-000332 Case I: 50% stress, Operating Temperature at 40°C (Ground fixed and controlled environment ). The resulting figure for MTBF is 1.316x10<sup>6</sup> hours.

MIL-HDBK-217F NOTICE2 FULL LOAD, Operating Temperature at 25°C °C. The resulting figure for MTBF is 3.465x10<sup>5</sup> hours.