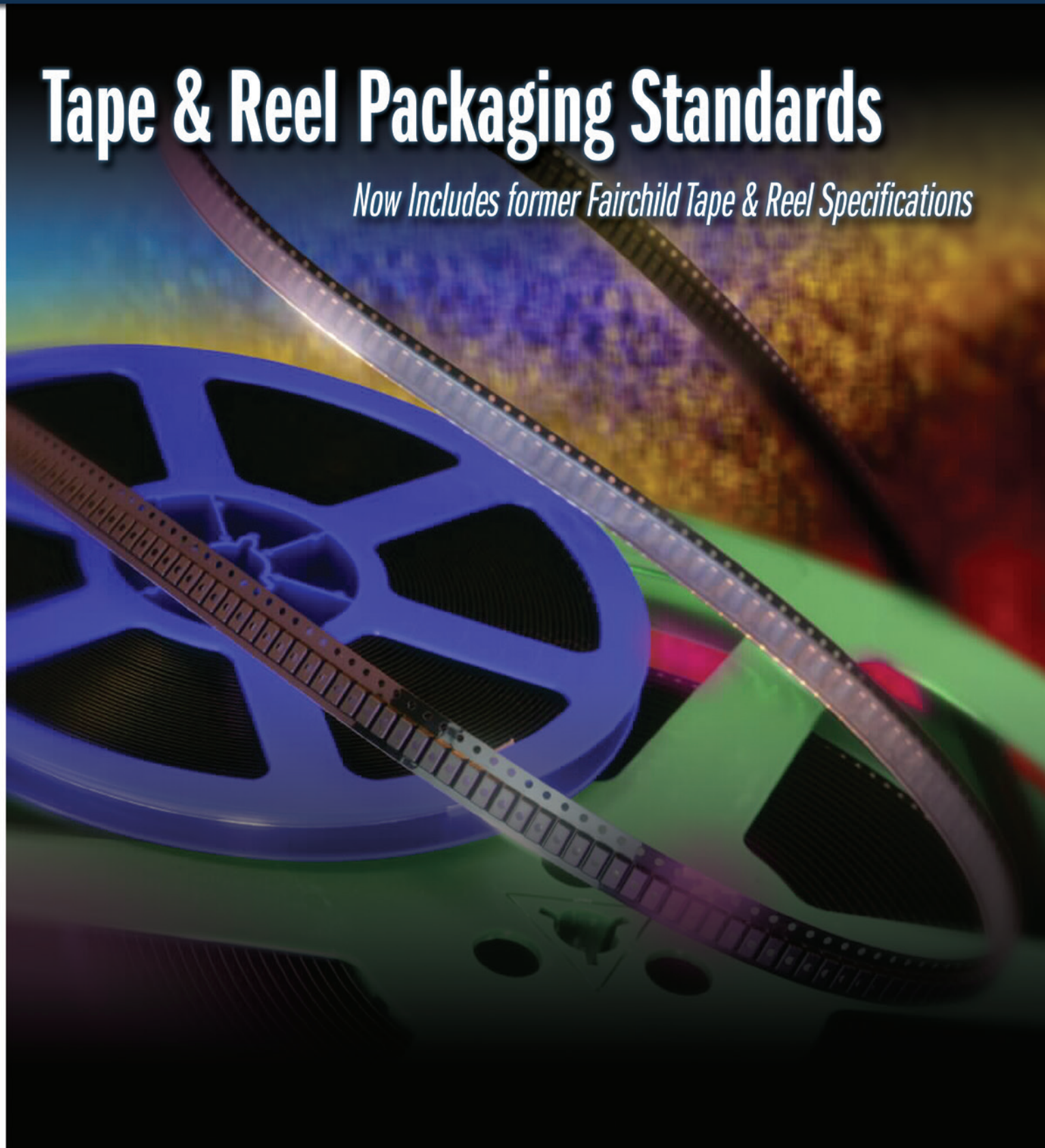




Tape & Reel Packaging Standards

Now Includes former Fairchild Tape & Reel Specifications



Tape and Reel Packaging Standards

BRD8011/D
Rev. 22, Jun–2018


© SCILLC, 2018
Previous Edition © February, 2018
“All Rights Reserved”



ON Semiconductor®

www.onsemi.com

Micro8 is a trademark of International Rectifier.
PowerFLEX is a trademark of Texas Instruments Incorporated.
POWERMITE is registered trademark of and used under a license from Microsemi Corporation.
MicroLeadless is a trademark of Semiconductor Components Industries, LLC (SCILLC).

ON Semiconductor and  are trademarks of Semiconductor Components Industries, LLC dba ON Semiconductor or its subsidiaries in the United States and/or other countries. ON Semiconductor owns the rights to a number of patents, trademarks, copyrights, trade secrets, and other intellectual property. A listing of ON Semiconductor's product/patent coverage may be accessed at www.onsemi.com/site/pdf/Patent-Marking.pdf. ON Semiconductor reserves the right to make changes without further notice to any products herein. ON Semiconductor makes no warranty, representation or guarantee regarding the suitability of its products for any particular purpose, nor does ON Semiconductor assume any liability arising out of the application or use of any product or circuit, and specifically disclaims any and all liability, including without limitation special, consequential or incidental damages. Buyer is responsible for its products and applications using ON Semiconductor products, including compliance with all laws, regulations and safety requirements or standards, regardless of any support or applications information provided by ON Semiconductor. "Typical" parameters which may be provided in ON Semiconductor data sheets and/or specifications can and do vary in different applications and actual performance may vary over time. All operating parameters, including "Typicals" must be validated for each customer application by customer's technical experts. ON Semiconductor does not convey any license under its patent rights nor the rights of others. ON Semiconductor products are not designed, intended, or authorized for use as a critical component in life support systems or any FDA Class 3 medical devices or medical devices with a same or similar classification in a foreign jurisdiction or any devices intended for implantation in the human body. Should Buyer purchase or use ON Semiconductor products for any such unintended or unauthorized application, Buyer shall indemnify and hold ON Semiconductor and its officers, employees, subsidiaries, affiliates, and distributors harmless against all claims, costs, damages, and expenses, and reasonable attorney fees arising out of, directly or indirectly, any claim of personal injury or death associated with such unintended or unauthorized use, even if such claim alleges that ON Semiconductor was negligent regarding the design or manufacture of the part. ON Semiconductor is an Equal Opportunity/Affirmative Action Employer. This literature is subject to all applicable copyright laws and is not for resale in any manner.

PUBLICATION ORDERING INFORMATION

LITERATURE FULFILLMENT:

Literature Distribution Center for ON Semiconductor
P.O. Box 5163, Denver, Colorado 80217 USA
Phone: 303-675-2175 or 800-344-3860 Toll Free USA/Canada
Fax: 303-675-2176 or 800-344-3867 Toll Free USA/Canada
Email: orderlit@onsemi.com

N. American Technical Support: 800-282-9855 Toll Free
USA/Canada
Europe, Middle East and Africa Technical Support:
Phone: 421 33 790 2910

ON Semiconductor Website: www.onsemi.com

Order Literature: <http://www.onsemi.com/orderlit>

For additional information, please contact your local Sales Representative

ON Semiconductor Tape and Reel Packaging Standards

In Brief . . .

This booklet has been offered to assist those looking to coordinate packaging specifications with assembly line requirements. Additionally, dimensional and ordering information is supplied for those discrete devices that take the form of axial-leaded parts.

	Page
Surface Mount	
Packaging Standards	4
Ordering Information	9
Former CMD Tape and Reel Standards	11
Former Fairchild Tape and Reel Standards	14
Product Orientation	21
Dimension Standards	30
Thru Hole	
TO-92 Radial Tape Specifications	36
(Fan Fold Box and on Reel)	
Axial-Leaded	
Lead Tape Standards for Axial-Lead Components	41
Information for Using	
Surface Mount Packages	42
Humidity Indicator Card	47

Tape and Reel Packaging Standards

Embossed Tape and Reel is used to facilitate automatic pick and place equipment feed requirements. The tape is used as the shipping container for various products and requires a minimum of handling. The antistatic/conductive tape provides a secure cavity for the product when sealed with the “peel-back” cover tape.

- Two Reel Sizes Available (7” and 13”)
- Used for Automatic Pick and Place Feed Systems
- Minimizes Product Handling
- EIA 481, -1, -2 Series
- DFN/QFN covers all other Thickness Designators for these packages; i.e. WDFN, UDFN, XDFN, etc..
- 8 mm Tape: 6-Bump, 9-Bump, 10-Bump, MicroLeadless™, ChipFET, DFN/QFN packages ≤ 3.3x3.3, DSN, Flip-Chip, SOD-123, SC-59, SC-70, SC-74, SC-74A, SC-75, SC-82, SC-82AB, SC-88, SC-88A, SC-89, SOD-123, SOD-323, SOD-523, SOD-723, SOD-923, SOT-143, SOT-23, SOT-23L, SOT-323, SOT-353, SOT-553/563, SOT-723, SOT-883, SOT-1123, TSOP-5, TSOP-6, US8, WLCSP-4, WLCSP-5, XDFN2, X3DFN, XLLGA
- 12 mm Tape: DFN/QFN packages > 3.3x3.3 and ≤ 7x7, FCBGA-16, Micro10, Micro8™, PowerFLEX™, POWERMITE™, QSOP-16, SMA, SMB, SO-8 (SOIC 8), SOT-223, SOT-89, SSOP-8, TSSOP-8, TSSOP-10, TSSOP-14, TSSOP-16
- 16 mm Tape: DFN/QFN packages > 7x7, DPAK, FCBGA-16, PLCC-20, QSOP-24, SMC, SO-14 (SOIC 14), SO-16 (SOIC 16), SO-16 Wide (SOIC 16W), SOIC-EIAJ8, SOIC-EIAJ14, SOIC-EIAJ16, SOP-16, SSOP-14 Wide, SSOP36-EP, TQFP-32, TSSOP-20
- 24 mm Tape: D²PAK, FCBGA-81, LQFP-52, LQFP-64, PLCC-28, SO-18 Wide (SOIC 18W), SO-20 Wide (SOIC 20W), SO-24 Wide (SOIC 24W), SOEIAJ-20, SSOP36-EP (Non-standard), TQFP-52, TQFP-64, TSSOP-48
- 32 mm Tape: PLCC-44, PLCC-52, SO-28L Wide (SOIC 28W), SO-28 Wide (SOIC 28W), SO-32 Wide (SOIC 32W),
- 44 mm Tape: PLCC-98, PLCC-84
- For Leadless Package Pin 1 Orientation, please see Figure 46 (Effective January 2007).

Use the standard device title and add the required suffix as listed in the option table on the following page. Note that the individual reels have a finite number of devices depending on the type of product contained in the tape. Also note the minimum lot size is one full reel for each line item, and orders are required to be in increments of the single reel quantity.

Embossed Tape and Reel Ordering Information

Package	Tape Width mm	Pitch mm (Dimension P ₁) (inch)	Reel Size		Devices Per Reel and Min Order Quantity	Tape and Reel Suffix	Fig No	Page No
			(mm)	(in)				
6-Bump (1.489x0.989)	8	4.0 ± 0.1 (0.158 ± 0.004)	178	7	3,000	T1 – TMOS	9	22
9-Bump (1.489x1.489)	8	4.0 ± 0.1 (0.158 ± 0.004)	178	7	3,000	T1 – TMOS	9	22
10-Bump	8	4.0 ± 0.1 (0.158 ± 0.004)	178	7	3,000	T1 – Discrete	9	22
Axial Leaded	See Axial Leaded package standards beginning on page 36							
ChipFET	8	4.0 ± 0.1 (0.158 ± 0.004)	178	7	3,000	T1 – TMOS	19	23
CPH3	8	4.0 ± 0.1 (0.158 ± 0.004)	178	7	3,000	T1	15	23
CPH4	8	4.0 ± 0.1 (0.158 ± 0.004)	178	7	3,000	T1	18	23
CPH5	8	4.0 ± 0.1 (0.158 ± 0.004)	178	7	3,000	T1	18	23
CPH6	8	4.0 ± 0.1 (0.158 ± 0.004)	178	7	3,000	T1, T2	26	25
DFN/QFN ≤ 1.2x1.6x0.9	8	4.0 ± 0.1 (0.157 ± 0.004)	330	13	8000	N/A	41	41
DFN/QFN ≤ 1.4x1.4mm	8	2.0 ± 0.1 (0.079 ± 0.004)	178	7	See Data Sheet	Various	41-46	27,28
DFN/QFN ≤ 3.3x3.3mm	8 8	4.0 ± 0.1 (0.158 ± 0.004) 4.0 ± 0.1 (0.158 ± 0.004)	178 330	7 13	See Data Sheet See Data Sheet	See Data Sheet See Data Sheet	41-46	27,28
DFN/QFN ≥ 3.0x3.0mm and ≤ 7x7mm	12 12	8.0 ± 0.1 (0.315 ± 0.004) 8.0 ± 0.1 (0.315 ± 0.004)	178 330	7 13	See Data Sheet See Data Sheet	See Data Sheet See Data Sheet	41-46	27,28
DFN/QFN 7x7mm	12 12	16.0 ± 0.1 (0.630 ± 0.004) 16.0 ± 0.1 (0.630 ± 0.004)	178 330	7 13	See Data Sheet See Data Sheet	See Data Sheet See Data Sheet	41-46	27,28
DFN/QFN 9x9mm	16 16	12.0 ± 0.1 (0.471 ± 0.004) 12.0 ± 0.1 (0.471 ± 0.004)	178 330	7 13	See Data Sheet See Data Sheet	See Data Sheet See Data Sheet	41-46	27,28
DFN/QFN 10x10mm	16 16	16.0 ± 0.1 (0.630 ± 0.004) 16.0 ± 0.1 (0.630 ± 0.004)	178 330	7 13	See Data Sheet See Data Sheet	See Data Sheet See Data Sheet	41-46	27,28
DFN/QFN 10.5x10.5mm	16 16	16.0 ± 0.1 (0.630 ± 0.004) 16.0 ± 0.1 (0.630 ± 0.004)	178 330	7 13	See Data Sheet See Data Sheet	See Data Sheet See Data Sheet	41-46	27,28
DO-41	79	5.08 ± 0.508	356	14	5,000	RL – Discrete	N/A	41
D ² PAK 3 Lead	24	16.0 ± 0.1 (0.630 ± 0.004)	330	13	800	R4 Analog T4 – Discrete	1	21
D ² PAK 5 Lead	24	16.0 ± 0.1 (0.630 ± 0.004)	330	13	800	R4 – Analog T4 – Discrete	1	21
D ² PAK 7 Lead	24	16.0 ± 0.1 (0.630 ± 0.004)	330	13	750	R7 – Analog	1	21
DPAK	16	12.0 ± 0.1 (0.471 ± 0.004)	330	13	1,800	RL – Discrete	4	21
DPAK	16	8.0 ± 0.1 (0.315 ± 0.004)	330	13	2,500	T4, T5 – Discrete RK, T5 – Analog	2, 3	21
DPAK (TP-FA)	16	8.0 ± 0.1 (0.315 ± 0.004)	178	7	700	T4	3	21
DPAK (Single Gauge)	16	8.0 ± 0.1 (0.315 ± 0.004)	330	13	3,000	T4	3	21
DSN	8	2.0 ± 0.05 (0.079 ± 0.002)	178	7	5,000	T5 – Discrete	8	22
FCBGA-16	12	8.0 ± 0.1 (0.315 ± 0.004)	330	13	2,500/500	R2 – Clock & Data Mgmt	40	27
FCBGA-49	16	12.0 ± 0.1 (0.471 ± 0.004)	330	13	2,000/500	R2 – Clock & Data Mgmt	40	27
FCBGA-81	24	12.0 ± 0.1 (0.471 ± 0.004)	330	13	1,500/500	R2 – Clock & Data Mgmt	40	27
Flip-Chip	8	4.0 ± 0.1 (0.157 ± 0.004)	178	7	3,000	T1 – Discrete	N/A	N/A
LGA17 5.97x3.43	12	8.0 ± 0.1 (0.315 ± 0.004)	178	7	250	XTP	41	27
LQFP – 48	16	12.0 ± 0.1 (0.471 ± 0.004)	330	13	2,000	R48 – Analog	10	22
LQFP-32	16	12.0 ± 0.1 (0.471 ± 0.004)	330	13	1800 or 2000	R2 – Clock & Data Mgmt	10	22
LQFP-52	24	16.0 ± 0.1 (0.630 ± 0.004)	330	13	1,500	R2 – Clock & Data Mgmt	10	22
LQFP-64	24	16.0 ± 0.1 (0.630 ± 0.004)	330	13	1,500	R2 – Clock & Data Mgmt	10	22

Embossed Tape and Reel Ordering Information

Package	Tape Width mm	Pitch mm (Dimension P ₁) (inch)	Reel Size		Devices Per Reel and Min Order Quantity	Tape and Reel Suffix	Fig No	Page No
			(mm)	(in)				
Micro10	12	8.0 ± 0.1 (0.315 ± 0.004)	330	13	4,000	R2 – Analog, Discrete	6	21
Micro8™	12	8.0 ± 0.1 (0.315 ± 0.004)	330	13	2,500	R2, T – Analog	6	21
Micro8	12	8.0 ± 0.1 (0.315 ± 0.004)	330	13	4,000	R2 – Analog, Discrete	6	21
PLCC-20	16	12.0 ± 0.1 (0.471 ± 0.004)	330	13	1,000	R2 – Clock & Data Mgmt	11	22
PLCC-28	24	16.0 ± 0.1 (0.630 ± 0.004)	330	13	500	R2 – Clock & Data Mgmt	11	22
PLCC-44	32	24.0 ± 0.1 (0.942 ± 0.004)	330	13	500	R2 – Clock & Data Mgmt, Analog	11	22
PLCC-44	32	24.0 ± 0.1 (0.942 ± 0.004)	330	13	500	R44 – Analog	11	22
PLCC-52	32	24.0 ± 0.1 (0.942 ± 0.004)	330	13	500	R2 – Clock & Data Mgmt, Analog	11	22
PLCC-68	44	32.0 ± 0.1 (1.256 ± 0.004)	330	13	250	R2 – Clock & Data Mgmt, Analog	11	22
PLCC-84	44	36.0 ± 0.1 (1.418 ± 0.004)	330	13	250	R2 – Clock & Data Mgmt, Analog	11	22
PowerFLEX™	12	24.0 ± 0.1 (0.942 ± 0.004)	330	13	2,000	R7 – Analog	1	21
POWERMITE®	12	4.0 ± 0.1 (0.157 ± 0.004)	178	7	3,000	T1, TR7 – Discrete	24	24
POWERMITE	12	4.0 ± 0.1 (0.157 ± 0.004)	330	13	12,000	T3, TR13 – Discrete	24	24
SC-59	8	4.0 ± 0.1 (0.157 ± 0.004)	178	7	3,000	T1, T2 – Discrete	15	23
SC-59	8	4.0 ± 0.1 (0.157 ± 0.004)	330	13	10,000	T3 – Discrete	15	23
SC-70	8	4.0 ± 0.1 (0.157 ± 0.004)	178	7	3,000	T1 – Discrete	15	23
SC-70	8	4.0 ± 0.1 (0.157 ± 0.004)	330	13	10,000	T3 – Discrete	15	23
SC-70FL	8	4.0 ± 0.1 (0.157 ± 0.004)	178	7	3,000	T1	15	23
SC-70 5 Lead	8	4.0 ± 0.1 (0.157 ± 0.004)	178	7	3,000	T1 – Analog	17	23
SC-70 6 Lead	8	4.0 ± 0.1 (0.157 ± 0.004)	178	7	3,000	T1 – Analog	26	25
SC-70 6 Lead	8	4.0 ± 0.1 (0.157 ± 0.004)	330	13	10,000	T3 – Analog	26	25
SC-74	8	4.0 ± 0.1 (0.157 ± 0.004)	178	7	3,000	T1 – Discrete	16	23
SC-74A	8	4.0 ± 0.1 (0.157 ± 0.004)	178	7	3,000	T1 – Discrete	14	23
SC-75	8	4.0 ± 0.1 (0.157 ± 0.004)	178	7	3,000	T1 – Discrete	15	23
SC-82	8	4.0 ± 0.1 (0.157 ± 0.004)	178	7	3,000	TR – Analog	12	23
SC-82AB	8	4.0 ± 0.1 (0.157 ± 0.004)	178	7	3,000	T1 – Analog, Discrete	12	23
SC-82FL	8	4.0 ± 0.1 (0.157 ± 0.004)	178	7	3,000	T1	13	23
SC-88	8	4.0 ± 0.1 (0.157 ± 0.004)	330	13	10,000	T3 – Discrete	26	25
SC-88	8	4.0 ± 0.1 (0.157 ± 0.004)	178	7	3,000	T1, T2 – Discrete T1 – Analog	26	25
SC-88FL	8	4.0 ± 0.1 (0.157 ± 0.004)	178	7	3,000	T1	26	25
SC-88A	8	4.0 ± 0.1 (0.157 ± 0.004)	178	7	3,000	T1, T2 – Discrete	17	23
SC-88A	8	4.0 ± 0.1 (0.157 ± 0.004)	330	13	10,000	T3, T4 – Discrete	17	23
SC-88AFL	8	4.0 ± 0.1 (0.157 ± 0.004)	178	7	3,000	T1	17	23
SC-89	8	4.0 ± 0.1 (0.157 ± 0.004)	178	7	3,000	T1 – Discrete	15	23
SC-89	8	4.0 ± 0.1 (0.157 ± 0.004)	330	13	10,000	T3 – Discrete	15	23
SIP16 3.12x4.57	12	8.0 ± 0.1 (0.315 ± 0.004)	178	7	250	T	44	27
SIP21 3.10x5.08	12	8.0 ± 0.1 (0.315 ± 0.004)	178	7	250	T	44	27

Embossed Tape and Reel Ordering Information

Package	Tape Width mm	Pitch mm (Dimension P ₁) (inch)	Reel Size		Devices Per Reel and Min Order Quantity	Tape and Reel Suffix	Fig No	Page No
			(mm)	(in)				
SIP25 5.59x3.18	12	8.0 ± 0.1 (0.315 ± 0.004)	178	7	250	T	44	27
SIP25 5.72x3.18	12	8.0 ± 0.1 (0.315 ± 0.004)	178	7	250	T	44	27
SIP32 3.68x6.35	12	8.0 ± 0.1 (0.315 ± 0.004)	178	7	250	T	44	27
SIP33 3.10x4.75	12	8.0 ± 0.1 (0.315 ± 0.004)	178	7	250		44	27
SIP49 3.94x7.39	16	8.0 ± 0.1 (0.315 ± 0.004)	178	7	250		44	27
SIP51 8x6	16	12.0 ± 0.1 (0.471 ± 0.004)	560	22	3,000	N/A	45	27
SMA	12	4.0 ± 0.1 (0.157 ± 0.004)	178	7	1,500	T1 – Discrete	25	24
SMA	12	4.0 ± 0.1 (0.157 ± 0.004)	330	13	5,000	T3 – Discrete	25	24
SMB	12	8.0 ± 0.1 (0.315 ± 0.004)	178	7	1,000	T1 – Discrete	25	24
SMB	12	8.0 ± 0.1 (0.315 ± 0.004)	330	13	2,500	T3 – Discrete	25	24
SMC	16	8.0 ± 0.1 (0.315 ± 0.004)	330	13	2,500	T3 – Discrete	25	24
SO-8 (SOIC 8)	12	8.0 ± 0.1 (0.315 ± 0.004)	330	13	2,500 / 3,000	R8 – Analog E.G.*	6	21
SO-8 (SOIC 8)	12	8.0 ± 0.1 (0.315 ± 0.004)	330	13	2,500 / 3,000	R2 – CMOS, Analog, Clock & Data Mgmt	6	21
SO-8 (SOIC 8)	12	8.0 ± 0.1 (0.315 ± 0.004)	330	13	2,500 / 3,000	T3 – EEPROM	6	21
SO-10 (SOIC 10)	12	8.0 ± 0.1 (0.315 ± 0.004)	330	13	2,500	R2 – Analog	6	21
SO-14 (SOIC 14)	16	8.0 ± 0.1 (0.315 ± 0.004)	330	13	3,000	R14 – Analog E.G.*	6	21
SO-14 (SOIC 14)	16	8.0 ± 0.1 (0.315 ± 0.004)	330	13	3,000	R2 – Clock & Data Mgmt, Logic, Analog	6	21
SO-16 (SOIC 16)	16	8.0 ± 0.1 (0.315 ± 0.004)	330	13	3,000	R2 – Clock & Data Mgmt, Logic, Analog	6	21
SO-16 (SOIC 16)	16	8.0 ± 0.1 (0.315 ± 0.004)	330	13	3,000	R16 – Analog E.G.*	6	21
SO-16 Wide (SOIC 16W)	16	8.0 ± 0.1 (0.315 ± 0.004)	330	13	1,500	R2 – Clock & Data Mgmt, Logic, Analog	6	21
SO-16 Wide (SOIC 16W)	16	8.0 ± 0.1 (0.315 ± 0.004)	330	13	1,500	R16 – Analog E.G.*	6	21
SO-18 Wide (SOIC 18W)	24	12.0 ± 0.1 (0.471 ± 0.004)	330	13	1,000	R2 – Clock & Data Mgmt	6	21
SO-18 Wide (SOIC 18W)	24	12.0 ± 0.1 (0.471 ± 0.004)	330	13	1,000	R18 – Analog E.G.*	6	21
SO-20 Wide (SOIC 20W)	24	12.0 ± 0.1 (0.471 ± 0.004)	330	13	1,500	R2 – Analog, Clock & Data Mgmt	6	21
SO-20 Wide (SOIC 20W)	24	12.0 ± 0.1 (0.471 ± 0.004)	330	13	1,500	R20 – Analog E.G.*	6	21
SO-24 Wide (SOIC 24W)	24	12.0 ± 0.1 (0.471 ± 0.004)	330	13	1,500	R2 – Analog, Clock & Data Mgmt	6	21
SO-24 Wide (SOIC 24W)	24	12.0 ± 0.1 (0.471 ± 0.004)	330	13	1,500	R24 – Analog E.G.*	6	21
SO-28 Wide (SOIC 28W)	24	12.0 ± 0.1 (0.471 ± 0.004)	330	13	1,000	R2 – Analog, Clock & Data Mgmt	5	21
SO-28L Wide (SOIC 28W)	32	12.0 ± 0.1 (0.471 ± 0.004)	330	13	1,000	R3 – Analog	5	21
SO-28 Wide (SOIC 28W)	32	12.0 ± 0.1 (0.471 ± 0.004)	330	13	1,000	R28 – Analog E.G.*	5	21
SO-32 Wide (SOIC 32W)	32	12.0 ± 0.1 (0.471 ± 0.004)	330	13	1,000	R32 – Analog E.G.*	6	21

Embossed Tape and Reel Ordering Information

Package	Tape Width mm	Pitch mm (Dimension P ₁) (inch)	Reel Size		Devices Per Reel and Min Order Quantity	Tape and Reel Suffix	Fig No	Page No
			(mm)	(in)				
SOIC NB 8/10 (SOIC8/SONB8) (SOIC10/SONB10)	12	8.0 ± 0.1 (0.315 ± 0.004)	178	7	2,500	R1	6	21
			330	13	2,500	R2	6	21
SOIC-EIAJ8	16	12.0 ± 0.1 (0.471 ± 0.004)	330	13	2,000	T2 – EEPROM	6	21
SOIC-EIAJ14	16	12.0 ± 0.1 (0.471 ± 0.004)	330	13	2,000	EL – Logic	6	21
SOIC-EIAJ16	16	12.0 ± 0.1 (0.471 ± 0.004)	330	13	2,000	EL – Logic	6	21
SOIC-EIAJ20	24	12.0 ± 0.1 (0.471 ± 0.004)	330	13	2,000	EL – Logic	6	21
SOD-123	8	4.0 ± 0.1 (0.157 ± 0.004)	178	7	3,000	T1, T2 – Discrete	30	25
SOD-123	8	4.0 ± 0.1 (0.157 ± 0.004)	330	13	10,000	T3 – Discrete	30	25
SOD-323	8	4.0 ± 0.1 (0.157 ± 0.004)	178	7	3,000	T1 – Discrete	30	25
SOD-323	8	4.0 ± 0.1 (0.157 ± 0.004)	330	13	10,000	T3 – Discrete	30	25
SOD-523	8	4.0 ± 0.1 (0.157 ± 0.004)	178	7	3,000	T1 – Discrete	33	26
SOD-523	8	2.0 ± 0.05 (0.079 ± 0.002)	178	7	8,000	T5 – Discrete	33	26
SOD-723	8	2.0 ± 0.05 (0.079 ± 0.002)	178	7	8,000	T5 – Discrete	34	26
SOD-923	8	2.0 ± 0.05 (0.079 ± 0.002)	178	7	8,000	T5 – Discrete	34	26
SON-6	8	4.0 ± 0.1 (0.157 ± 0.004)	178	7	3,000	T1 – Analog	31	25
SON-8	8	4.0 ± 0.1 (0.157 ± 0.004)	178	7	3,000	T1 – Analog	N/A	N/A
SOP-16	16	8.0 ± 0.1 (0.315 ± 0.004)	330	13	2,500	R2 – Analog	6	21
SOT-143	8	4.0 ± 0.1 (0.157 ± 0.004)	330	13	10,000	T3, T4 – Discrete	29	25
SOT-143	8	4.0 ± 0.1 (0.157 ± 0.004)	178	7	3,000	T1, T2, Discrete T – Analog	29	25
SOT-223	12	8.0 ± 0.1 (0.315 ± 0.004)	178	7	1,000	T1 – Discrete, Analog	35	26
SOT-223	12	8.0 ± 0.1 (0.315 ± 0.004)	330	13	2,500	R3 or T3 – Analog E.G.*	35	26
SOT-223	12	8.0 ± 0.1 (0.315 ± 0.004)	330	13	4,000	T3 – Discrete, TMOS T3 – Analog	35	26
SOT-23	8	4.0 ± 0.1 (0.157 ± 0.004)	178	7	3,000	T1, – Discrete TR, T1 – Analog	15	23
SOT-23	8	4.0 ± 0.1 (0.157 ± 0.004)	330	13	10,000	T3 – Discrete	15	23
SOT-23 5 Lead	8	4.0 ± 0.1 (0.157 ± 0.004)	178	7	3,000	T1, TR, T – Analog	14	23
SOT-23 6 Lead	8	4.0 ± 0.1 (0.157 ± 0.004)	178	7	3,000	T1, R1 – Analog	16	23
SOT-23L	8	4.0 ± 0.1 (0.157 ± 0.004)	178	7	4,000	R2 – Analog	15	23
SOT-28FL	8	4.0 ± 0.1 (0.157 ± 0.004)	178	7	3,000	T1	37	26
SOT-323	8	4.0 ± 0.1 (0.157 ± 0.004)	178	7	3,000	T1 – Discrete	15	23
SOT-323	8	4.0 ± 0.1 (0.157 ± 0.004)	330	13	10,000	T3 – Discrete	15	23
SOT-353	8	4.0 ± 0.1 (0.157 ± 0.004)	178	7	3,000	T1, T2 – Discrete	17	23
SOT-353	8	4.0 ± 0.1 (0.157 ± 0.004)	330	13	10,000	T3, T4 – Discrete	17	23
SOT-383FL	8	4.0 ± 0.1 (0.157 ± 0.004)	178	7	3,000	T1	37	26
SOT-553/563	8	4.0 ± 0.1 (0.157 ± 0.004)	178	7	4,000	T1 – Discrete, Logic	20,21	24
SOT-553/563	8	4.0 ± 0.1 (0.157 ± 0.004)	178	7	4,000	T2 – Discrete, Logic, Analog	20,21	24
SOT-553/563	8	4.0 ± 0.1 (0.157 ± 0.004)	178	7	5,000	T3 – Discrete	20,21	24
SOT-553/563	8	2.0 ± 0.05 (0.079 ± 0.002)	178	7	8,000	T5 – Discrete, Logic	20,21	24
SOT-553/563	8	2.0 ± 0.05 (0.079 ± 0.002)	178	7	8,000	T6 – Discrete, Logic	20,21	24

Embossed Tape and Reel Ordering Information

Package	Tape Width mm	Pitch mm (Dimension P ₁) (inch)	Reel Size		Devices Per Reel and Min Order Quantity	Tape and Reel Suffix	Fig No	Page No
			(mm)	(in)				
SOT-623	8	2.0 ± 0.05 (0.079 ± 0.002)	178	7	8,000	T3	15	23
SOT-723	8	4.0 ± 0.1 (0.157 ± 0.004)	178	7	4,000	T1 – Discrete	36	21
SOT-723	8	2.0 ± 0.05 (0.079 ± 0.002)	178	7	8,000	T5 – Discrete	36	21
SOT-89	12	8.0 ± 0.1 (0.315 ± 0.004)	178	7	1,000	T1, R1 – Discrete T1 – Analog	27	25
	12	8.0 ± 0.1 (0.315 ± 0.004)	330	13	2,500			
SOT-89	12	8.0 ± 0.1 (0.315 ± 0.004)	178	7	1,000	T2	27	25
SOT-883	8	2.0 ± 0.1 (0.158 ± 0.004)	178	7	8,000	T5 – Discrete	7	22
SOT-953/963	8	2.0 ± 0.05 (0.079 ± 0.002)	178	7	8,000	T5 – Discrete, Logic	22,23	24
SOT-1123	8	2.0 ± 0.1 (0.158 ± 0.004)	178	7	8,000	T5 – Discrete	32	25
SSOP-8	12	8.0 ± 0.1 (0.315 ± 0.004)	330	13	3,000	T1 – Analog	6	21
SSOP-14	16	12.0 ± 0.1 (0.471 ± 0.004)	330	13	2,000	R14 – Analog E.G.*	6	21
SSOP-16	16	12.0 ± 0.1 (0.471 ± 0.004)	330	13	2,000	R16 – Analog E.G.*	6	21
SSOP-20	16	12.0 ± 0.1 (0.471 ± 0.004)	330	13	2,000	R20 – Analog E.G.*	6	21
SSOP-24 Wide	16	12.0 ± 0.1 (0.471 ± 0.004)	330	13	2,000	R24 – Analog E.G.*	6	21
SSOP-36 EP	16	12.0 ± 0.1 (0.471 ± 0.004)	330	13	1,500	R2 – Analog	6	21
SSOP-36 EP	24*	12.0 ± 0.1 (0.471 ± 0.004)	330	13	1,500	R2 – Analog (*Non-standard)	6	21
TO-92	See TO-92 and other Axial Leaded package specifications beginning on page 36							
TQFP-32	16	12.0 ± 0.1 (0.471 ± 0.004)	330	13	2,000	R2 – Analog, Clock & Data Mgmt	10	22
TQFP-52	24	16.0 ± 0.1 (0.630 ± 0.004)	330	13	1,500	R2 – Clock & Data Mgmt	10	22
TQFP-64	24	16.0 ± 0.1 (0.630 ± 0.004)	330	13	1,500	R2 – Clock & Data Mgmt	10	22
TSOP-5	8	4.0 ± 0.1 (0.157 ± 0.004)	178	7	3,000	T1, T2 – Discrete T1, T2, TR – Analog	14	23
	8	4.0 ± 0.1 (0.157 ± 0.004)	330	13	10,000			
TSOP-5	8	4.0 ± 0.1 (0.157 ± 0.004)	178	7	3,000	T3 – Discrete	14	23
TSOP-6	8	4.0 ± 0.1 (0.157 ± 0.004)	178	7	3,000	T1, T2 – Analog, Discrete	16	23
TSOP-6	8	4.0 ± 0.1 (0.157 ± 0.004)	330	13	10,000	T3 – Analog, Discrete	16	23
TSSOP-10	12	8.0 ± 0.1 (0.315 ± 0.004)	330	13	2,500	R2 – Clock & Data Mgmt	6	21
TSSOP-14	12	8.0 ± 0.1 (0.315 ± 0.004)	330	13	2,500	R2 – Analog, Clock & Data Mgmt	6	21
TSSOP-16	12	8.0 ± 0.1 (0.315 ± 0.004)	330	13	2,500	R2 – Analog, Clock & Data Mgmt	6	21
TSSOP-20	16	8.0 ± 0.1 (0.315 ± 0.004)	330	13	2,500	R2 – Analog, Clock & Data Mgmt	6	21
TSSOP-24	16	8.0 ± 0.1 (0.315 ± 0.004)	330	13	2,500	R2 – Analog, Clock & Data Mgmt	6	21
TSSOP-48	24	12.0 ± 0.1 (0.471 ± 0.004)	330	13	2,500	R2 – Clock & Data Mgmt	6	21
TSSOP-8	12	8.0 ± 0.1 (0.315 ± 0.004)	330	13	2,500	R2 – Analog, Clock & Data Mgmt	6	21
TSSOP-8	12	8.0 ± 0.1 (0.315 ± 0.004)	330	13	4,000	R2 – Discrete, MOS	6	21
TSSOP-8	12	8.0 ± 0.1 (0.315 ± 0.004)	330	13	3,000	R3 – Discrete, MOS	6	21
US8	8	4.0 ± 0.1 (0.157 ± 0.004)	178	7	3,000	US – Logic	28	25

* Applies to Analog devices manufactured at the East Greenwich, Rhode Island, USA facility.

Embossed Tape and Reel Ordering Information

Package	Tape Width mm	Pitch mm (Dimension P ₁) (inch)	Reel Size		Devices Per Reel and Min Order Quantity	Tape and Reel Suffix	Fig No	Page No
			(mm)	(in)				
WLCSP (EFCP) 1.01x1.01mm	8	2.0 ± 0.05 (0.079 ± 0.002)	178	7	8000	TC	46	28
WLCSP (EFCP) 1.91x1.46mm 1.81x1.81mm 1.61x1.61mm 1.46x1.46mm 1.26x1.26mm 2.7x1.81mm	8	4.0 ± 0.1 (0.079 ± 0.004)	178	7	5000	TC	46	28
WLCSP (EFCP) 3.05x1.77mm	8	4.0 ± 0.1 (0.079 ± 0.004)	178	7	5000	TD	46	28
WLCSP (EFCP) 3.54x1.77mm	12	4.0 ± 0.1 (0.079 ± 0.004)	178	7	5000	TD	46	28
WLCSP 3-Bump 0.940x0.772mm	8	4.0 ± 0.1 (0.157 ± 0.004)	178	7	4000	N/A	43	27
WLCSP 4-Bump 0.626x0.609mm	8	4.0 ± 0.1 (0.157 ± 0.004)	178	7	4000	N/A	43	27
WLCSP 4-Bump 0.862x0.609mm	8	4.0 ± 0.1 (0.157 ± 0.004)	178	7	4000	N/A	43	27
WLCSP 4-Bump 0.964x0.609mm	8	4.0 ± 0.1 (0.157 ± 0.004)	178	7	4000	N/A	43	27
WLCSP 4-Bump 1.009x0.609mm	8	4.0 ± 0.1 (0.157 ± 0.004)	178	7	4000	N/A	43	27
WLCSP 6-Bump 1.097x0.622mm	8	4.0 ± 0.1 (0.157 ± 0.004)	178	7	4000	N/A	43	27
WLCSP 8-Bump 0.652x0.834mm	8	4.0 ± 0.1 (0.157 ± 0.004)	178	7	4000	N/A	43	27
WLCSP 12-Bump 0.652x1.134mm	8	4.0 ± 0.1 (0.157 ± 0.004)	178	7	4000	N/A	43	27
WLCSP 8-Bump 0.722x0.879mm	8	4.0 ± 0.1 (0.157 ± 0.004)	178	7	4000	N/A	43	27
WLCSP 10-Bump 0.722x1.029mm	8	4.0 ± 0.1 (0.157 ± 0.004)	178	7	4000	N/A	43	27
WLCSP 12-Bump 0.722x1.179mm	8	4.0 ± 0.1 (0.157 ± 0.004)	178	7	4000	N/A	43	27
WLCSP ≤ 0.86x0.84mm	8	2.0 ± 0.1 (0.079 ± 0.004)	178	7	5000	TR	41-46	27,28
WLCSP ≤ 1.4x1.4mm	8	2.0 ± 0.1 (0.079 ± 0.004)	178	7	See Data Sheet	Various	41-46	27,28
WLCSP ≤ 3.3x3.3mm	8 8	4.0 ± 0.1 (0.158 ± 0.004) 4.0 ± 0.1 (0.158 ± 0.004)	178 330	7 13	See Data Sheet See Data Sheet	Various Various	41-46	27,28
WLCSP > 3.3x3.3mm and ≤ 7x7mm	12 12	8.0 ± 0.1 (0.315 ± 0.004) 8.0 ± 0.1 (0.315 ± 0.004)	178 330	7 13	See Data Sheet See Data Sheet	Various Various	41-46	27,28
WLCSP > 7x7mm and ≤ 8x8mm	12 12	16.0 ± 0.1 (0.630 ± 0.004) 16.0 ± 0.1 (0.630 ± 0.004)	178 330	7 13	See Data Sheet See Data Sheet	Various Various	41-46	27,28
WLCSP > 8x8mm and ≤ 10.5x10.5mm	16 16	12.0 ± 0.1 (0.471 ± 0.004) 12.0 ± 0.1 (0.471 ± 0.004)	178 330	7 13	See Data Sheet See Data Sheet	Various Various	41-46	27,28
WLCSP >10.5x10.5mm	16 16	16.0 ± 0.1 (0.630 ± 0.004) 16.0 ± 0.1 (0.630 ± 0.004)	178 330	7 13	See Data Sheet See Data Sheet	Various Various	41-46	27,28
XDFN2	8	2.0 ± 0.1 (0.158 ± 0.004)	178	7	8,000	T5 – Discrete	7	22
X3DFN <1.3x1.3mm	8	2.0 ± 0.1 (0.158 ± 0.004)	178	7	10,000	T5 – Discrete	38	27
XLLGA	8	2.0 ± 0.1 (0.158 ± 0.004)	178	7	8,000	T5 – Discrete	39	27

* Applies to Analog devices manufactured at the East Greenwich, Rhode Island, USA facility.

Former CMD Tape & Reel Standards, by Package

Former CMD Tape and Reel Standards by Package

Package	Package Size (mm)	Tape Width	Reel Diameter	Quantity per Reel	P ₀	P ₁	Orientation Quadrant
CSP, 2-Bump	0.60 x 0.30 x 0.275	8 mm	178 mm (7")	15,000	4 mm	4 mm	Top
CSP, 4-Bump	0.8 x 0.8 x 0.50	8 mm	178 mm (7")	10,000	4 mm	2 mm	B
CSP, 4-Bump	0.8 x 0.8 x 0.60	8 mm	178 mm (7")	5000	4 mm	4 mm	B
CSP, 4-Bump	0.96 x 0.96 x 0.644	8 mm	178 mm (7")	3500	4 mm	4 mm	B
CSP, 4-Bump	0.96 x 0.96 x 0.65	8 mm	178 mm (7")	3500	4 mm	4 mm	B
CSP, 5-Bump	1.05 x 0.76 x 0.615	8 mm	178 mm (7")	3500	4 mm	4 mm	B
CSP, 5-Bump	1.20 x 0.80 x 0.60	8 mm	178 mm (7")	5000	4 mm	4 mm	B
CSP, 5-Bump	1.33 x 0.96 x 0.606	8 mm	178 mm (7")	3500	4 mm	4 mm	A
CSP, 5-Bump	1.33 x 0.96 x 0.644	8 mm	178 mm (7")	3500	4 mm	4 mm	A
CSP, 5-Bump	1.41 x 0.93 x 0.606	8 mm	178 mm (7")	3500	4 mm	4 mm	A
CSP, 5-Bump	1.41 x 0.95 x 0.644	8 mm	178 mm (7")	3500	4 mm	4 mm	A
CSP, 5-Bump	1.59 x 1.22 x 0.64	8 mm	178 mm (7")	3500	4 mm	4 mm	B
CSP, 6-Bump	1.46 x 0.96 x 0.644	8 mm	178 mm (7")	3500	4 mm	4 mm	B
CSP, 6-Bump	1.72 x 1.22 x 0.64	8 mm	178 mm (7")	3500	4 mm	4 mm	B
CSP, 6-Bump	1.804 x 1.154 x 0.644	8 mm	178 mm (7")	3500	4 mm	4 mm	B
CSP, 8-Bump	1.16 x 1.16 x 0.60	8 mm	178 mm (7")	5000	4 mm	4 mm	B
CSP, 8-Bump	1.20 x 1.20 x 0.60	8 mm	178 mm (7")	5000	4 mm	4 mm	B
CSP, 8-Bump	1.43 x 1.41 x 0.605	8 mm	178 mm (7")	3500	4 mm	4 mm	B
CSP, 8-Bump	1.60 x 1.60 x 0.65	8 mm	178 mm (7")	5000	4 mm	4 mm	B
CSP, 9-bump	2.470 x 0.970 x 0.606	8 mm	178 mm (7")	3500	4 mm	4 mm	B
CSP, 9-bump	2.470 x 0.970 x 0.644	8 mm	178 mm (7")	3500	4 mm	4 mm	B
CSP, 10-Bump	1.56 x 1.053 x 0.615	8 mm	178 mm (7")	3500	4 mm	4 mm	B
CSP, 10-Bump	1.67 x 1.11 x 0.615	8 mm	178 mm (7")	3500	4 mm	4 mm	B
CSP, 10-Bump	1.67 x 1.14 x 0.615	8 mm	178 mm (7")	3500	4 mm	4 mm	B
CSP, 10-Bump	1.96 x 1.33 x 0.606	8 mm	178 mm (7")	3500	4 mm	4 mm	B
CSP, 10-Bump	1.96 x 1.33 x 0.644	8 mm	178 mm (7")	3500	4 mm	4 mm	A
CSP, 10-Bump	2.46 x 0.96 x 0.644	8 mm	178 mm (7")	3500	4 mm	4 mm	B
CSP, 10-Bump	3.104 x 1.154 x 0.682	8 mm	178 mm (7")	3500	4 mm	4 mm	B
CSP, 11-Bump	1.46 x 1.96 x 0.65	8 mm	178 mm (7")	5000	4 mm	4 mm	B
CSP, 11-Bump	2.05 x 1.44 x 0.644	8 mm	178 mm (7")	3500	4 mm	4 mm	B
CSP, 14-Bump	2.00 x 1.10 x 0.58	8 mm	178 mm (7")	3500	4 mm	4 mm	B
CSP, 15-Bump	2.36 x 1.053 x 0.262	8 mm	178 mm (7")	3500	4 mm	4 mm	B
CSP, 15-Bump	2.36 x 1.053 x 0.615	8 mm	178 mm (7")	3500	4 mm	4 mm	B
CSP, 15-Bump	2.36 x 1.053 x 0.644	8 mm	178 mm (7")	3500	4 mm	4 mm	B
CSP, 15-Bump	2.47 x 1.11 x 0.615	8 mm	178 mm (7")	3500	4 mm	4 mm	B
CSP, 15-Bump	2.47 x 1.14 x 0.615	8 mm	178 mm (7")	3500	4 mm	4 mm	B
CSP, 15-Bump	2.96 x 1.33 x 0.605	8 mm	178 mm (7")	3500	4 mm	4 mm	B
CSP, 15-Bump	2.96 x 1.33 x 0.615	8 mm	178 mm (7")	3500	4 mm	4 mm	B

For orientation and dimension standards, see diagrams on page 29.

Former CMD Tape and Reel Standards by Package

Package	Package Size (mm)	Tape Width	Reel Diameter	Quantity per Reel	P ₀	P ₁	Orientation Quadrant
CSP, 15-Bump	2.96 x 1.33 x 0.644	8 mm	178 mm (7")	3500	4 mm	4 mm	B
CSP, 15-Bump	3.16 x 1.053 x 0.644	8 mm	178 mm (7")	3500	4 mm	4 mm	B
CSP, 15-Bump	3.006 x 1.376 x 0.644	8 mm	178 mm (7")	3500	4 mm	4 mm	B
CSP, 15-Bump	3.01 x 1.38 x 0.644	8 mm	178 mm (7")	3500	4 mm	4 mm	B
CSP, 18-Bump	1.96 x 1.56 x 0.60	8 mm	178 mm (7")	5000	4 mm	4 mm	B
CSP, 20-Bump	3.16 x 1.053 x 0.615	8 mm	178 mm (7")	3500	4 mm	4 mm	B
CSP, 20-Bump	3.27 x 1.11 x 0.615	12 mm	330 mm (13")	3500	4 mm	4 mm	B
CSP, 20-Bump	3.96 x 1.33 x 0.644	8 mm	178 mm (7")	3500	4 mm	8 mm	B
CSP, 20-Bump	3.96 x 1.586 x 0.640	12 mm	330 mm (13")	3500	4 mm	4 mm	B
CSP, 20-Bump	4.00 x 1.46 x 0.605	12 mm	330 mm (13")	3500	4 mm	4 mm	B
CSP, 20-Bump	4.00 x 1.46 x 0.606	12 mm	330 mm (13")	3500	4 mm	8 mm	B
CSP, 20-Bump	4.00 x 1.46 x 0.644	12 mm	330 mm (13")	3500	4 mm	8 mm	B
CSP, 20-Bump	4.006 x 1.376 x 0.644	12 mm	330 mm (13")	3500	4 mm	4 mm	B
CSP, 24-Bump	1.96 x 1.96 x 0.60	8 mm	178 mm (7")	5000	4 mm	4 mm	B
CSP, 24-Bump	2.06 x 2.06 x 0.6	8 mm	178 mm (7")	5000	4 mm	4 mm	B
CSP, 24-Bump	2.60 x 2.60 x 0.65	8 mm	178 mm (7")	500	4 mm	4 mm	B
CSP, 25-Bump	2.00 x 2.00 x 0.60	8 mm	178 mm (7")	500	4 mm	4 mm	B
CSP, 49-Bump	2.80 x 2.80 x 0.50	8 mm	178 mm (7")	500	4 mm	4 mm	B
CSP, 49-Bump	2.80 x 2.80 x 0.60	8 mm	178 mm (7")	500	4 mm	4 mm	B
MSOP-8	3.00 x 3.00 x 0.85	12 mm	330 mm (13")	4000	4 mm	8 mm	A
MSOP-10	3.00 x 3.00 x 0.85	12 mm	330 mm (13")	4000	4 mm	8 mm	A
QSOP-16	4.90 x 3.89 x 1.55	12 mm	330 mm (13")	2500	4 mm	8 mm	A
QSOP-24	8.65 x 3.90 x 1.35	16 mm	178 mm (7")	1000	4 mm	8 mm	A
QSOP-24	8.65 x 3.90 x 1.35	16 mm	330 mm (13")	2500	4 mm	8 mm	A
SC70-3	2.05 x 1.25 x 0.95	8 mm	178 mm (7")	3000	4 mm	4 mm	C
SC70-5	2.05 x 1.25 x 0.95	8 mm	178 mm (7")	3000	4 mm	4 mm	C
SC70-5	2.05 x 1.25 x 0.95	8 mm	178 mm (7")	3000	4 mm	4 mm	C
SC70-6	2.05 x 1.25 x 0.95	8 mm	178 mm (7")	3000	4 mm	4 mm	C
SOD-882	1.00 x 0.60 x 0.50	8 mm	178 mm (7")	5000	4 mm	4 mm	A
SOIC-8	4.90 x 3.99 x 1.55	12 mm	330 mm (13")	2500	4 mm	8 mm	A
SOIC-8	4.90 x 6.00 x 1.55	12 mm	330 mm (13")	2500	4 mm	8 mm	A
SOT143	2.92 x 2.37 x 1.01	8 mm	178 mm (7")	3000	4 mm	4 mm	C
SOT143-4	2.92 x 2.37 x 1.01	8 mm	178 mm (7")	3000	4 mm	4 mm	C
SOT23-3	2.92 x 2.37 x 1.01	8 mm	178 mm (7")	3000	4 mm	4 mm	C
SOT23-5	2.92 x 2.79 x 1.24	8 mm	178 mm (7")	3000	4 mm	4 mm	C
SOT23-6	2.90 x 2.80 x 1.45	8 mm	178 mm (7")	3000	4 mm	4 mm	C
SOT-553	1.60 x 1.60 x 0.55	8 mm	178 mm (7")	5000	4 mm	4 mm	C
SOT-563	1.60 x 1.60 x 0.55	8 mm	178 mm (7")	5000	4 mm	4 mm	C
SOT-593	1.00 x 0.80 x 0.45	8 mm	178 mm (7")	8000	4 mm	4 mm	B
CUDFN-6	1.60 x 1.60 x 0.60	8 mm	178 mm (7")	2500	4 mm	4 mm	A

For orientation and dimension standards, see diagrams on page 29.

Former CMD Tape and Reel Standards by Package

Package	Package Size (mm)	Tape Width	Reel Diameter	Quantity per Reel	P ₀	P ₁	Orientation Quadrant
CUDFN-6	2.00 x 2.00 x 0.65	8 mm	178 mm (7")	2500	4 mm	4 mm	A
TDFN-8	1.70 x 1.35 x 0.75	8 mm	178 mm (7")	3000	4 mm	4 mm	A
TDFN-8	2.00 x 2.00 x 0.75	8 mm	178 mm (7")	3000	4 mm	4 mm	A
TDFN-8	3.00 x 3.00 x .075	12 mm	330 mm (13")	3000	4 mm	8 mm	A
TDFN-12	3.00 x 1.35 x 0.75	8 mm	178 mm (7")	3000	4 mm	4 mm	A
TDFN-16	4.00 x 1.60 x 0.75	12 mm	178 mm (7")	3000	4 mm	4 mm	A
TDFN-16	4.00 x 1.70 x 0.75	12 mm	330 mm (13")	3000	4 mm	8 mm	A
TDFN-16	6.00 x 4.00 x 0.75	12 mm	330 mm (13")	3000	4 mm	8 mm	A
TSSOP-8	3.00 x 6.38 x 1.10	12 mm	330 mm (13")	2500	4 mm	8 mm	A
TSSOP-38	9.70 x 6.40 x 1.20	16 mm	330 mm (13")	2500	4 mm	12 mm	A
UDFN-6	1.25 x 1.0 x 0.50	8 mm	178 mm (7")	3000	4 mm	4 mm	A
UDFN-8	1.70 x 1.35 x 0.50	8 mm	178 mm (7")	3000	4 mm	4 mm	A
UDFN-8	1.70 x 1.35 x 0.50	8 mm	178 mm (7")	3000	4 mm	4 mm	A
UDFN-8	2.00 x 2.00 x 0.55	8 mm	178 mm (7")	3000	4 mm	4 mm	A
UDFN-12	2.50 x 1.20 x 0.50	8 mm	178 mm (7")	3000	4 mm	4 mm	A
UDFN-12	2.50 x 1.35 x 0.50	8 mm	178 mm (7")	3000	4 mm	4 mm	A
UDFN-16	3.30 x 1.35 x 0.50	8 mm	178 mm (7")	3000	4 mm	4 mm	A
uUDFN-10	2.50 x 1.00 x 0.50	8 mm	178 mm (7")	3000	4 mm	4 mm	A
X3DFN	0.62 x 0.62 x 0.32	8 mm	178 mm (7")	15,000	2 mm	2 mm	Top

For orientation and dimension standards, see diagrams on page 29.

Former Fairchild Tape & Reel Standards

Former Fairchild Tape and Reel Standards by Package

Package	Case Outline Code	FCS MOD	Tape Width	P1	Pin 1 Orientation	Reel Size (mm)	Reel Size (Inch)	MPQ
28 Lead TSSOP	948AA	MTC28	16 mm	8 mm	Top left	330 mm	13"	2500
ARUSM-313 / REFLECTIVE RECTANGULAR SURFACE MOUNT	100CY	ARU313A	12 mm	8 mm	Top right	178 mm	7"	1000
AXIAL LEAD	017AG	DO35A	Ammo Packing					10000
AXIAL LEAD	017AH	DO41A	Ammo Packing					3000
Axial Lead	017AF	DO201A	64 mm	10 mm	Cathode reel	330 mm	13"	1250
AXIAL LEAD DO 204	017AJ	DO15A	64 mm	5.0 mm	Not provided	330 mm	13"	4000
D2PAK-3 (TO-263, 3-LEAD)	418AJ	TO263A02	24 mm	16 mm	Not Indicated	330 mm	13"	1600
D2PAK3 (TO-263 3 LD)	418BF	TO263C03	Tube	Tube		Tube	Tube	800
D2PAK6 (TO-263 6 LD)	418AX	TO263A06	24 mm	16 mm	Not Indicated	330 mm	13"	800
D2PAK7 (TO-263 7 LD)	418AZ	TO263A08	24 mm	16 mm	Not Indicated	330 mm	13"	800
D2PAK7 (TO-263 7 LD)	418AY	TO263A07	24 mm	16 mm	Not Indicated	330 mm	13"	800
DFN6 2X2, 0.65P	506DQ	MLP06B	8 mm	4 mm	Top left	178 mm	7"	3000
DFN8 5.1x6.3, 1.27P	506DW	PQFN08P	12 mm					3000
DFN8 5x6, 1.27P	506DR	MLP08P	12 mm	8 mm	Top left	330 mm	13"	3000
DPAK3	369AK	TO252D03	16 mm	8 mm				2500
DPAK3 (TO-252 3 LD)	369AS	TO252A03	16 mm	8 mm	Not Indicated	330 mm	13"	5000
DPAK5	369AL	TO252B05	16 mm					2500
H-PSOF8L 11.68x9.90	100CU	PSOF08A						2000
LGA16 3.3x3.3	715AC	LGA16A	12 mm	8 mm	Top left	330 mm	13"	3000
LQFP32, 7x7	561AB	VBE32A	16 mm	16 mm	Top left	330 mm	13"	2000
MFP4 2.5X4.4, 1.27P	100AL	MFP04A	Tube 9.4	Tube	no info			2500
MFP4 3.85X4.4, 2.54P	100AP	MFP04C	Tube 9.4	Tube	no info			2500
MFP5 4.1X4.4, 2.54P	100AM	MFP05A	Tube 9.4	Tube	no info			2500
Micro 8 lead Surface Mount	846A-02	MUA08A	12 mm	8 mm	Top left	330 mm	13"	4000
MiniMELF / SOD-80	100AD	SOD80A	8 mm					2500
MSOP10	846AP	MUA10A	12 mm	8 mm	Top left	330 mm	13"	4000
PDIP4 GW	709AH	N04C	16 MM	12 MM	Not sure	330 mm	13"	1000
PDIP4 GW	709AE	SDIP04A	16 mm	12 mm	Top right	330 mm	13"	1500
PDIP6 7.3x6.5, 2.54P	646CE	N06F	16 mm	12 mm	Not Indicated	330 mm	13"	1000
PDIP6 8.51x6.35, 2.54P	646BY	N06C	24 mm	12 mm	Not Indicated	330 mm	13"	1000
PDIP7 MINUS PIN 6 GW	707AA	MLSOP07A	16 mm	12 mm	Top left	330 mm	13"	1000
PDIP8 GW	709AC	N08H	16 mm	12 mm	Not Indicated	330 mm	13"	1000
PDIP8 GW	709AF	N08K	16 mm	12 mm	Top left	330 mm	13"	1000
PDIP8 GW	709AJ	MLSOP08A	16 mm	12 mm	Bottom left	330 mm	13"	1000
PDIP8 GW	709AD	N08L	16 mm	12 mm	Top Left	330 mm	13"	700
PLCC 2 LEAD	776AU	DCD192A	8 mm	4 mm	Top left Top right	178 mm	7"	3000
PLCC 2 LEAD	776AX	DCD02A	12 mm	8 mm	Top left Top right	178 mm	7"	1000

Former Fairchild Tape and Reel Standards by Package

Package	Case Outline Code	FCS MOD	Tape Width	P1	Pin 1 Orientation	Reel Size (mm)	Reel Size (Inch)	MPQ
PLCC 2 LEAD	776AY	DCD02B	12 mm	8 mm	Top left Top right	178 mm	7"	1000
PQFN12 3.3X5, 0.65P	483BN	PQFN12B	12 mm	8 mm	Top left	330 mm	13"	3000
PQFN22 4.5x3.5, 0.5P	483BU	PQFN22A	12 mm	8 mm	Top Right	330 mm	13"	3000
PQFN27 12.9X12.9, 0.65P	483AD	PQFN27A	24 mm	16 mm	Bottom left	330 mm	13"	1000
PQFN31 5X5, 0.5P	483BQ	PQFN31A	12 MM	8 mm	Top left	330 mm	13"	3000
PQFN34 5X5.5, 0.5P	483AM	PQFN34A	12 mm	8 mm	Top left	330 mm	13"	3000
PQFN36 6X7.5, 0.5P	483BB	PQFN36B	16 mm	12 mm	Top left	330 mm	13"	3000
PQFN4 8X8, 2P	483AP	PQFN04A	16 mm	12 mm	Top left	330 mm	13"	3000
PQFN40 6X6, 0.5P	483AN	PQFN40A	12 mm	8 mm	Top left	330 mm	13"	3000
PQFN6 2.05X2.05, 0.65P	483AV	PQFN06A	8 mm	4 mm	Top left	178 mm	7"	3000
PQFN8 3.3X3.3, 0.65P	483AW	PQFN08H	12 mm	8 mm	Top Left	330 mm	13"	3000
PQFN8 3.3X3.3, 0.65P	483AX	PQFN08S	12 mm	8 mm	Top Left	330 mm	13"	3000
PQFN8 3.3X3.3, 0.65P	483AL	PQFN08C	12 mm	8 mm	Top Left	330 mm	13"	3000
PQFN8 3.3X3.3, 0.65P	483AY	PQFN08X	12 mm					3000
PQFN8 3.3X3.3, 0.65P	483AZ	PQFN08G	12 mm	8 mm	Top Left	330 mm	13"	3000
PQFN8 3.3X3.3, 0.65P	483BP	PQFN08L	12 mm	8 mm	Top Left	330 mm	13"	3000
PQFN8 3.3X5, 0.65P	483AU	PQFN08N	12 mm	8 mm	Top Left	330 mm	13"	3000
PQFN8 5X6, 1.27P	483AT	PQFN08Q	12 mm	8 mm	Top Left	330 mm	13"	3000
PQFN8 5X6, 1.27P	483AS	PQFN08O	12 mm	8 mm	Top Left	330 mm	13"	3000
PQFN8 5X6, 1.27P	483AF	PQFN08T	12 mm	8 mm	Top left	330 mm	13"	3000
PQFN8 5X6, 1.27P	483AE	PQFN08A	12 mm	8 mm	Top Left	330 mm	13"	3000
PQFN8 5X6, 1.27P	483BK	PQFN08D	12 mm	8 mm	Top Left	330 mm	13"	3000
PQFN8 5X6, 1.27P	483AJ	PQFN08E	12 mm	8 mm	Top Left	330 mm	13"	3000
PQFN8 5X6, 1.27P	483BJ	PQFN08M	12 mm	8 mm	Top Left	330 mm	13"	3000
PQFN8 5X6, 1.27P	483AG	PQFN08J	12 mm	8 mm	Top Left	330 mm	13"	3000
PQFN8 5X6, 1.27P	483AR	PQFN08K	12 mm	8 mm	Top Left	330 mm	13"	3000
PQFN8 5X6, 1.27P	483BL	PQFN08U	12 mm	8 mm	Top left	330 mm	13"	3000
PQFN8 8X8, 2P	483AQ	PQFN08R	16 mm	12 mm	Top left	330 mm	13"	3000
QFN14 3.0x2.5, 0.5P	510CB	MLP14A	12 mm	8 mm	Top left	330 mm	13"	3000
QSOP-16	492-01	MQA16A	12 mm	8 mm	Top Left	330 mm	13"	2500
QSOP24 NB	492B-01	MQA24	16 mm	8 mm	Top Left	330 mm	13"	2500
SC-70, 3 Lead, 1.25x2	419AB	MAA03A	8 mm	4 mm	Bottom left	178 mm	7"	3000
SC-88 (SC-70 6 Lead), 1.25x2	419AD	MAA06A	8 mm	4 mm	Bottom left	178 mm	7"	3000
SC-88A (SC-70 5 Lead), 1.25x2	419AC	MAA05A	8 mm	4 mm	Bottom left	178 & 330 mm	7" & 13"	3000
SIDELOOKER DETECTOR	100CK	DDD136A	Tube or Bag Packing		Tube or Bag Packing			1000
SIDELOOKER DETECTOR	100CN	DDD132A	18.5					2000
SIDELOOKER EMITTER	100CJ	DDE131A	18.5					2000
SIP6 1.45X1.0	127EB	MAC06A	8 mm	4 mm	Bottom left	178 mm	7"	5000
SMA	403AE	DO214AC	12 mm	8 mm	Not Indicated	330 mm	13"	7500
SMB	403AF	DO214AA	12 mm	8 mm	Top left	330 mm	13"	3000
SMC	403AG	DO214AB	16 mm	8 mm	Not Indicated	330 mm	13"	3000
SOD-123 2 LEAD	425-04	MA02A	8 mm	4 mm	Top left Top right	178 mm	7"	3000

Former Fairchild Tape and Reel Standards by Package

Package	Case Outline Code	FCS MOD	Tape Width	P1	Pin 1 Orientation	Reel Size (mm)	Reel Size (Inch)	MPQ
SOD-123EP	425AC	MA02C	8 mm	4 mm	Top left Top right	178 mm	7"	3000
SOD-123FL	425AD	MA02B	8 mm	4 mm	Top left Top right	178 mm	7"	3000
SOD-123FL	425AB	MA02D	8 mm	4 mm	Top left Top right	178 mm	7"	3000
SOD-323EP	477AD	SOD323HE	8 mm	4 mm	Top left Top right	178 mm	7"	3000
SOD-323FL	477AB	SOD323F2	8 mm	4 mm	Top left Top right	178 mm	7"	3000
SOD-523 2 LEAD	502-01	SOD523F1	8 mm	4 mm	Top left Top right	178 mm	7"	8000
SOD-923	514AA	SOD923F1	8 mm	4 mm	Top left Top right	178 mm	7"	8000
SOIC-16, 150 mils	751BG	M16A	16 mm	8 mm	Top left	330 mm	13"	2500
SOIC-16, 300 mils	751BH	M16B	16 mm	12 mm	Top left	330 mm	13"	1000
SOIC-20, 300 mils	751BJ	M20B	24 mm	12 mm	Top Left	330 mm	7"	1000
SOIC-28, 300 mils	751BM	M28B	24 mm	12 mm	Top left	330 mm	13"	1000
SOIC14	751EF	M14A	16 mm	8 mm	Top Left	330 mm	13"	2500
SOIC14 N	751ER	M14C	16 mm	8 mm	Bottom left	330 mm	13"	3000
SOIC16 N	751ES	M16E	16 mm	8 mm	Top left	330 mm	13"	3000
SOIC16 W	751EN	M16F	24 mm	16 mm	top left	330 mm	13"	750
SOIC4 W	751EP	M04A	12 mm	8 mm	Not Indicated	330 mm	13"	3000
SOIC6	751EL	M06B	16 mm	12 mm	Top left	330 mm	13"	1000
SOIC6 W	751EM	M06C	16 mm	12 mm	Top left	330 mm	13"	1000
SOIC6 W LESS PIN 2	752AF	M05A	24 mm	8 mm	Top right	330 mm	13"	1000
SOIC6 W LESS PIN 2	752AG	M05B	24 mm	8 mm	Top right	330 mm	13"	1000
SOIC7	751ED	M07B	12 mm	8 mm	Top left	330 mm	13"	2500
SOIC8	751DZ	M08E	Tube 9.4	Tube	no info			2500
SOIC8	751EG	M08B	12 mm	8 mm	Bottom left	330 mm	13"	3000
SOIC8	751EB	M08A						2500
SOIC8 N MISSING PIN 7	751EA	M07A	12 mm	8 mm	Top left	330 mm	13"	2500
SOP14	565BE	M14D	16 mm	12 mm	Top Left	330 mm	13"	2000
SOP16	565BF	M16D	16 mm	12 mm	Top Left	330 mm	13"	2000
SOP20	565BG	M20D	24 mm	12 mm	Top left	330 mm	13"	2000
SOT-1123, 1.0x0.6x0.37, 0.35P	524AA	SOT923F1	8 mm	4 mm	Top	178 mm	7"	8000
SOT-23	318BM	MA03D	8 mm	4 mm	Bottom left	178 & 330 mm	7" & 13"	3000
SOT-23, 3 Lead, 1.3x2.9	527AG	MA03B	8 mm	4 mm	Bottom left	178 & 330 mm	7" & 13"	3000
SOT-23, 5 Lead, 1.6x2.9	527AH	MA05B	8 mm	4 mm	Bottom left	178 & 330 mm	7" & 13"	3000
SOT-23, 6 Lead, 1.6x2.9	527AJ	MA06E	8 mm	4 mm	Top left	178 mm	7"	3000
SOT-23FL	419BD	MA03E	8 mm	4 mm	Bottom Left	178 mm	7"	3000
SOT-523FL	419BG	MAD03A	8 mm	4 mm	Bottom left	178 mm	7"	3000
SOT-563	419BH	MAD06A	8 mm	4 mm	Bottom left	178 mm	7"	3000
SPM5D-023 / SPM5_SPM23-BA SMD TYPE	MODEH	MOD23DE	44 mm	24 mm	Not Indicated	330 mm	13"	450
SPM5H-023 / 23LD, PDD STD, SPM23-BD (Ver1.5) SMD TYPE	MODEM	MOD23DG	44 mm	24 mm	Not Indicated	330 mm	13"	450

Former Fairchild Tape and Reel Standards by Package

Package	Case Outline Code	FCS MOD	Tape Width	P1	Pin 1 Orientation	Reel Size (mm)	Reel Size (Inch)	MPQ
SSOP28	565BD	MSA28	16 mm	12 mm	Top Left	330 mm	13"	2000
SSOP4 / LSOP04	565BH	LSOP04A	16 mm	8 mm	Bottom left	330 mm	13"	3000
T- 3/4, 2MM DETECTOR	100CB	DCD182A	12 mm	4 mm	Top	178 mm	7"	1000
T-1 3/4, 5MM DETECTOR	100CE	DBD112A	20.5					1200
T-1 3/4, 5MM LED	100CC	DBE111A	16 mm	12 mm	Top left	330 mm	13"	1200
T-3/4, 2MM LED	100CA	DCE181A	12 mm	4 mm	Top	178 mm	7"	1000
TO-277-3LD	340BQ	TO277A03	12 mm	8 mm	Top Left	330 mm	13"	5000
TO-92 3 4.83x4.76 LEADFORMED	135AR	ZA03F	18 mm	12.7 mm	Ammo Packing		14"	2000
TSOT23, 6-Lead, 2.9x1.6	419AG	MA06A	8 mm	4 mm	Bottom left	178 & 330 mm	7" & 13"	3000
TSSOP 16	948AH	MTC16	12 mm	8 mm	Top Left	330 mm	13"	2500
TSSOP-14 WB	948G	MTC14	12 mm	8 mm	Top left	330 mm	13"	2500
TSSOP20, 4.4x6.5	948AQ	MTC20	16 mm	8 mm	Top Left	330 mm	13"	2500
TSSOP24, 4.4x7.8	948AR	MTC24	16 mm	8 mm	Top left	330 mm	13"	2500
TSSOP4 4.975x4.375 / Micro-DIP	948BT	TDI04B	12 mm	8 mm	not indicated	330 mm	13"	4000
TSSOP4 5.0x4.4 / Micro-DIP	948BS	TDI04A	12 mm	8 mm	not indicated	330 mm	13"	4000
TSSOP48 12.5x6.1	948BQ	MTD48	24 mm	12 mm	Top Left	330 mm	13"	1000
TSSOP56 14x6.1	948BR	MTD56	24 mm	12 mm	Top Left	330 mm	13"	1000
UDFN6 1.0X1.0, 0.35P	517DP	MGF06A	8 mm	4 mm	Bottom left	178 mm	7"	5000
UDFN6 1.6x1.6, 0.5P	517DW	UMLP06D	8 mm	4 mm	Top left	178 mm	7"	5000
UDFN6 1.6x1.6, 0.5P	517DV	UMLP06F	8 mm	4 mm	Top Left	178 mm	7"	5000
UDFN6 2x2, 0.65P	517DS	UMLP06E	8 mm	4 mm	Top left	178 mm	7"	3000
UDFN6 2x2, 0.65P	517DR	UMLP06C	8 mm	4 mm	Top left	178 mm	7"	3000
UDFN6 2x2, 0.65P	517DU	UMLP06B	8 mm	4 mm	Top left	178 mm	7"	3000
UQFN10 1.4x1.8, 0.4P	523BD	UMLP10S G	8 mm	4 mm	Top left	178 mm	7"	5000
UQFN10 1.4x1.8, 0.4P	523BC	UMLP10A	8 mm	4 mm	Top Left	178 mm	7"	5000
UQFN10 1.6X2.1, 0.5P	523AZ	MAC10A	8 mm	4 mm	Bottom left	178 mm	7"	5000
UQFN12 1.8x1.8, 0.4P	523BE	UMLP12A	8 mm	4 mm	Top left	178 mm	7"	5000
UQFN12, 1.7x2, 0.4P	523AE	UMLP12C	8 mm	4 mm	Top left	178 mm	7"	5000
UQFN16 1.8x2.6, 0.4P	523BF	UMLP16A	8 mm	4 mm	Top left	178 mm	7"	5000
UQFN16 3x3, 0.5P	523BB	UMLP16B	12 mm	8 mm	Not Indicated	330 mm	13"	3000
UQFN20 3x3, 0.4P	523BG	UMLP20B	12 mm	8 mm	Not Indicated	330 mm	13"	5000
UQFN20 3x4, 0.5P	523BA	UMLP20A	12 mm	8 mm	Top left	330 mm	13"	5000
UQFN24 2.5x3.4, 0.4P	523AX	UMLP24A	8 mm	4 mm	Top left	178 mm	7"	5000
UQFN8 1.6X1.6, 0.5P	523AY	MAC08A	8 mm	4 mm	Bottom left	178 mm	7"	5000
UQFN8, 1.4x1.2, 0.4P	523AS	UMLP08A	8 mm	4 mm	Top Left	178 mm	7"	5000
US8	846AN	MAB08A	8 mm	4 mm	Bottom left	178 mm	7"	3000
WDFN10 3x3, 0.5P	511DM	MLP10B	12 mm	8 mm	Top left	330 mm	13"	3000
WDFN10 3x3, 0.5P	511DP	MLP10J	12 mm	8 mm	Top left	330 mm	13"	3000
WDFN10 4x3, 0.8P	511CT	MLP10H	12 mm	8 mm	Top right	330 mm	13"	3000
WDFN10 4x4, 0.8P	511DU	MLP10M	12 mm	8 mm	Top Left	330 mm	13"	3000
WDFN12 3.5x3, 0.5P	511DK	MLP12D	12 mm	8 mm	Top Left	330 mm	13"	3000
WDFN12 5x4.5, 0.8P	511CS	MLP12E	12 mm	8 mm	Top left	330 mm	13"	3000
WDFN12 5x4.5, 0.8P	511CR	MLP12F	12 mm	8 mm	Top left	330 mm	13"	3000

Former Fairchild Tape and Reel Standards by Package

Package	Case Outline Code	FCS MOD	Tape Width	P1	Pin 1 Orientation	Reel Size (mm)	Reel Size (Inch)	MPQ
WDFN16 3x3, 0.5P	511DN	MLP16M	12 mm	8 mm	Top left	330 mm	13"	3000
WDFN6 2x2, 0.65P	511CY	MLP06K	8 mm	4 mm	Top left	178 mm	7"	3000
WDFN6 2x2, 0.65P	511DA	MLP06J	8 mm	4 mm	Top left	178 mm	7"	3000
WDFN6 2x2, 0.65P	511CZ	MLP06L	8 mm	4 mm	Top left	178 mm	7"	3000
WDFN6 2x2, 0.65P	511DB	MLP06P	8 mm	4 mm	Top left	178 mm	7"	3000
WDFN6 2x3, 0.65P	511CX	MLP06Q	8 mm	4 mm	Top right	178 mm	7"	3000
WDFN6 3x3, 0.95P	511CQ	MLP06F	12 mm	8 mm	Top left	330 mm	13"	3000
WDFN6 3x3, 0.95P	511DT	MLP06H	12 mm	8 mm	Top left	330 mm	13"	3000
WDFN6 3x3, 0.95P	511CP	MLP06D	12 mm	8 mm	Top left	330 mm	13"	3000
WDFN8 2x2, 0.5P	511DL	MLP08R	8 mm	4 mm	Top right	178 mm	7"	3000
WDFN8 3.3x3.3, 0.65P	511DH	MLP08S	12 mm	8 mm	Top left	330 mm	13"	3000
WDFN8 3.3x3.3, 0.65P	511DQ	MLP08W	8 mm	4 mm	Top left	178 mm	7"	3000
WDFN8 3.3x3.3, 0.65P	511DR	MLP08T	12 mm	8 mm	Top left	330 mm	13"	3000
WDFN8 3x1.9, 0.65P	511CW	MLP08H	8 mm	4 mm	Bottom left	178 mm	7"	3000
WDFN8 3x3, 0.5P	511DF	MLP08E	12 mm	8 mm	Top left	330 mm	13"	3000
WDFN8 3x3, 0.65P	511CD	MLP08D	12 mm	8 mm	Top left	330 mm	13"	3000
WDFN8 3x3, 0.65P	511DE	MLP08N	12 mm	8 mm	Top left	330 mm	13"	3000
WDFN8 3x3, 0.65P	511DG	MLP08X	12 mm	8 mm	Top left	330 mm	13"	3000
WDFN8 3x3, 0.65P	511DD	MLP08V	12 mm	8 mm	Top left	330 mm	13"	3000
WDFN8 3x4.5, 0.65P	511DJ	MLP08Q	12 mm	8 mm	Top left	330 mm	13"	3000
WDFN8 5x6, 1.27P	506DP	MLP08G	12 mm	8 mm	Top left	330 mm	13"	3000
WDFN8 5x6, 1.27P	511DC	MLP08Z	12 mm	8 mm	Top left	330 mm	13"	3000
WDFN8 5x6, 1.27P	506DS	MLP08K	12 mm	8 mm	Top left	330 mm	13"	3000
WLCSP12 1.235x1.625x0.586	567SX	UC012ZC	8 mm	4 mm	Top right	178 mm	7"	3000
WLCSP12 1.288x1.828x0.586	567QX	UC012ZC	8 mm	4 mm	Upper right	178 mm	7"	3000
WLCSP12 1.56x1.16x0.586	567QG	UC012AC	8 mm	4 mm	Top left	178 mm	7"	3000
WLCSP12 1.615x1.31x0.586	567RZ	UC012AC	8 mm	4 mm	Top left	178 mm	7"	3000
WLCSP12 1.615x1.415x0.586	567RY	UC012AC	8 mm	4 mm	Top left	178 mm	7"	3000
WLCSP12 1.66x1.42x0.5	567ST	UC012AD	8 mm	4 mm	Top Left	178 mm	7"	3000
WLCSP12 1.86x1.44x0.586	567QB	UC012AE	8 mm	4 mm	Top Left	178 mm	7"	3000
WLCSP12 1.8x1.41x0.5	567QR	UC012AD	8 mm	4 mm	Top Left	178 mm	7"	3000
WLCSP12 2.2x1.43x0.582	567PX	UC012AA	8 mm	4 mm	Upper left	178 mm	7"	3000
WLCSP15 1.56x1.56x0.586	567QH	UC015AA	8 mm	4 mm	Top Left	178 mm	7"	3000
WLCSP15 2.015x1.31x0.586	567QS	UC015AB	8 mm	4 mm	Top Left	178 mm	7"	3000
WLCSP15 2.2x1.6x0.574	567QY	UC015AC	8 mm	4 mm	Top left	178 mm	7"	3000
WLCSP16 1.56x1.56x0.586	567SA	UC016AA	8 mm	4 mm	Top left	178 mm	7"	3000
WLCSP16 1.615x1.615x0.586	567SD	UC016AA	8 mm	4 mm	Top left	178 mm	7"	3000
WLCSP16 1.61x1.61x0.586	567SB	UC016AA	8 mm	4 mm	Top left	178 mm	7"	3000
WLCSP16 1.71x1.71x0.586	567SC	UC016AA	8 mm	4 mm	Top left	178 mm	7"	3000
WLCSP16 1.71x1.86x0.586	567QJ	UC016AA	8 mm	4 mm	Top left	178 mm	7"	3000
WLCSP16 1.78x1.78x0.586	567SY	UC016AF	8 mm	4 mm	Top Left	178 mm	7"	3000
WLCSP16 1.81x1.81x0.586	567QZ	UC016AF	8 mm	4 mm	Top Left	178 mm	7"	3000
WLCSP16 1.96x1.76x0.586	567SE	UC016AA	8 mm	4 mm	Top left	178 mm	7"	3000
WLCSP20 1.96x1.56x0.586	567SJ	UC020AA	8 mm	4 mm	Top left	178 mm	7"	3000
WLCSP20 1.96x1.87x0.586	567SL	UC020AA	8 mm	4 mm	Top left	178 mm	7"	3000
WLCSP20 2.015x1.615x0.586	567QK	UC020AA	8 mm	4 mm	Top left	178 mm	7"	3000

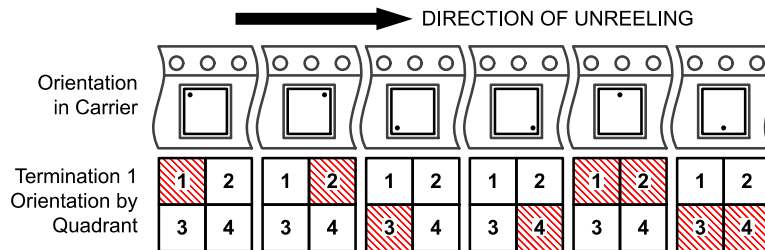
Former Fairchild Tape and Reel Standards by Package

Package	Case Outline Code	FCS MOD	Tape Width	P1	Pin 1 Orientation	Reel Size (mm)	Reel Size (Inch)	MPQ
WLCSP20 2.015x1.615x0.586	567SH	UC020AA	8 mm	4 mm	Top left	178 mm	7"	3000
WLCSP20 2.01x1.672x0.586	567SM	UC020AA	8 mm	4 mm	Top left	178 mm	7"	3000
WLCSP20 2.0x1.6x0.586	567SK	UC020AA	8 mm	4 mm	Top left	178 mm	7"	3000
WLCSP20 2.1x1.7x0.586	567SF	UC020AA	8 mm	4 mm	Top left	178 mm	7"	3000
WLCSP24 2.6x1.67x0.612	567TQ	UC024AA	8 mm	4 mm	Quadrant 1	178 mm	7"	3000
WLCSP25 2.015x2.015x0.586	567QL	UC025AA	8 mm	4 mm	Top Left	178 mm	7"	3000
WLCSP25 2.05x2.05x0.586	567SP	UC025AA	8 mm	4 mm	Top Left	178 mm	7"	3000
WLCSP25 2.1x2.1x0.586	567SN	UC025AA	8 mm	4 mm	Top Left	178 mm	7"	3000
WLCSP25 2.4x2.0x0.586	567SQ	UC025AA	8 mm	4 mm	Top Left	178 mm	7"	3000
WLCSP28 2.96x1.67x0.574	567QU	UC028AB	8 mm	4 mm	Bottom left	178 mm	7"	3000
WLCSP30 2.38x1.98x0.586	567SR	UC030AB	8 mm	4 mm	Top left	178 mm	7"	3000
WLCSP30 2.46x2.26x0.586	567QM	UC030AB	8 mm	4 mm	Top left	178 mm	7"	3000
WLCSP36 2.36x2.36x0.5	567QN	UC036AA	8 mm	4 mm	Top left	178 mm	7"	3000
WLCSP4 0.65x0.65x0.298	567QC	UC004AK	8 mm	4 mm	Top Left	178 mm	7"	3000
WLCSP4 0.76x0.76x0.586	567SS	UC004AF	8 mm	4 mm	Top left	178 mm	7"	3000
WLCSP4 0.82x0.82x0.586	567QD	UC004AC	8 mm	4 mm	Top Left	178 mm	7"	3000
WLCSP4 0.8x0.8x0.4	567RB	UC004AH	8 mm	4 mm	Bottom left	178 mm	7"	5000
WLCSP4 0.8x0.8x0.5	567QP	UC004AF	8 mm	4 mm	Top left	178 mm	7"	3000
WLCSP4 0.96x0.96x0.582	567RH	UC004AB	8 mm	4 mm	Bottom left	178 mm	7"	3000
WLCSP4 1.4x1.6x0.35	567RD	UC004AJ	8 mm	4 mm	Bottom left	178 mm	7"	5000
WLCSP4 1x1x0.4	567PS	UC004AD	8 mm	4 mm	Top left	178 mm	7"	5000
WLCSP4 1x1x0.582	567PU	UC004AB	8 mm	4 mm	Bottom left	178 mm	7"	3000
WLCSP5 1.35x0.98x0.625	567PV	UC005AA	8 mm	4 mm	Top left	178 mm	7"	3000
WLCSP6 1.16x0.76x0.586	567RU	UC006AC	8 mm	4 mm	Quadrant 1	178 mm	7"	3000
WLCSP6 1.16x0.86x0.586	567QE	UC006AC	8 mm	4 mm	Quadrant 1	178 mm	7"	3000
WLCSP6 1.16x0.86x0.586	567RQ	UC006AC	8 mm	4 mm	Quadrant 1	178 mm	7"	3000
WLCSP6 1.23x0.88x0.586	567RP	UC006AC	8 mm	4 mm	Quadrant 1	178 mm	7"	3000
WLCSP6 1.242x0.842x0.495	567TS	UC006AU	8 mm	4 mm	Quadrant 1	178 mm	7"	3000
WLCSP6 1.26x0.86x0.273	567RF	UC006AH	8 mm	4 mm	Quadrant 1	178 mm	7"	3000
WLCSP6 1.30x1.05x0.586	567RT	UC006AC	8 mm	4 mm	Quadrant 1	178 mm	7"	3000
WLCSP6 1.31x0.96x0.586	567RS	UC006AC	8 mm	4 mm	Quadrant 1	178 mm	7"	3000
WLCSP6 1.37x0.97x0.586	567RR	UC006AC	8 mm	4 mm	Quadrant 1	178 mm	7"	3000
WLCSP6 1.38x0.94x0.625	567UH	UC006AN	8 mm	4 mm	Quadrant 1	178 mm	7"	3000
WLCSP6 1.45x0.95x0.582	567RK	UC006AF	8 mm	4 mm	Quadrant 1	178 mm	7"	3000
WLCSP6 1.46x0.96x0.582	567RM	UC006AF	8 mm	4 mm	Quadrant 1	178 mm	7"	3000
WLCSP6 1.48x0.98x0.582	567RJ	UC006AF	8 mm	4 mm	Quadrant 1	178 mm	7"	3000
WLCSP6 1.48x0.98x0.582	567RN	UC006AF	8 mm	4 mm	Quadrant 1	178 mm	7"	3000
WLCSP6 1.5x1.0x0.582	567RL	UC006AF	8 mm	4 mm	Quadrant 1	178 mm	7"	3000
WLCSP6 1.5x1x0.6	567PW	UC006AA	8 mm	4 mm	Quadrant 1	178 mm	7"	5000
WLCSP6 1.66x0.96x0.582	567PY	UC006AF	8 mm	4 mm	Quadrant 1	178 mm	7"	3000
WLCSP6 1x1.5x0.4	567PT	UC006AE	8 mm	4 mm	Quadrant 1	178 mm	7"	5000
WLCSP6 2.3x1.3x0.35	567RE	UC006AB	8 mm	4 mm	Quadrant 1	178 mm	7"	5000
WLCSP8 1.57x1.57x0.582	567PZ	UC008AB	8 mm	4 mm	Top left	178 mm	7"	3000
WLCSP9 1.16x1.16x0.586	567RW	UC009AB	8 mm	4 mm	Quadrant 1	178 mm	7"	3000
WLCSP9 1.215x1.215x0.581	567QW	UC009AK	8 mm	4 mm	Quadrant 1	178 mm	7"	3000
WLCSP9 1.215x1.215x0.586	567RX	UC009AB	8 mm	4 mm	Quadrant 1	178 mm	7"	3000

Former Fairchild Tape and Reel Standards by Package

Package	Case Outline Code	FCS MOD	Tape Width	P1	Pin 1 Orientation	Reel Size (mm)	Reel Size (Inch)	MPQ
WLCSP9 1.215x1.26x0.581	567SW	UC009AK	8 mm	4 mm	Quadrant 1	178 mm	7"	3000
WLCSP9 1.21x1.21x0.581	567SU	UC009AK	8 mm	4 mm	Quadrant 1	178 mm	7"	3000
WLCSP9 1.21x1.21x0.586	567RV	UC009AB	8 mm	4 mm	Quadrant 1	178 mm	7"	3000
WLCSP9 1.26x1.215x0.526	567TN	UC009AL	8 mm	4 mm	Quadrant 1	178 mm	7"	3000
WLCSP9 1.292x1.342x0.5	567QQ	UC009AE	8 mm	4 mm	Quadrant 1	178 mm	7"	3000
WLCSP9 1.29x1.27x0.586	567QF	UC009AB	8 mm	4 mm	Quadrant 1	178 mm	7"	3000
WLCSP9 1.385x1.215x0.581	567SV	UC009AK	8 mm	4 mm	Quadrant 1	178 mm	7"	3000
WQFN12 3.3x3.3, 0.65P	510CJ	PQFN12A	12 mm					3000
WQFN14 2.5x2.5, 0.5P	510BR	MLP14D	12 mm	8 mm	Top left	330 mm	13"	3000
WQFN16 3.5x2.5, 0.5P	510CC	MLP16E	12 mm	8 mm	Top Left	330 mm	13"	3000
WQFN16 3x3, 0.5P	510BS	MLP16B	12 mm	8 mm	Top left	330 mm	13"	3000
WQFN16 3x3, 0.5P	510CF	MLP16HB	12 mm	8 mm	Top left	330 mm	13"	3000
WQFN20 3x4, 0.5P	510BT	MLP20D	12 mm	8 mm	Top left	330 mm	13"	3000
WQFN20 4.5x2.5, 0.5P	510CD	MLP20B	12 mm	8 mm	Top Left	330 mm	13"	3000
WQFN24 4.5x3.5, 0.5P	510CE	MLP24B	12 mm	8 mm	Top left	330 mm	13"	3000
WQFN24, 4x4, 0.5P	510BE	MLP24E	12 mm	8 mm	Top left	330 mm	13"	3000
WQFN25 6x5, 0.65P	510BQ	MLP25A	12 mm	8 mm	Top left	330 mm	13"	3000
WQFN32 5x5, 0.5P	510BU	MLP32A	12 mm	8 mm	Top Left	330 mm	13"	3000
WQFN32 5x5, 0.5P	510BV	MLP32B	12 mm	8 mm	Top Left	330 mm	13"	3000
WQFN40 6x6, 0.5P	510BY	MLP40E	12 mm	8 mm	Top left	330 mm	13"	3000
WQFN40 6x6, 0.5P	510BW	MLP40A	12 mm	8 mm	Top left	330 mm	13"	3000
X2DFN6 1x1, 0.35P	716AA	TMLP06A	8 mm	4 mm	Top Left	330 mm	13"	10000
X2QFN10 1.6x1.2, 0.4P	722AC	TMLP10A	8 mm	4 mm	Top Left	330 mm	13"	5000
X2QFN18, 2.0x2.8, 0.4P	722AB	TMLP18A	8 mm	4 mm	Top Left	330 mm	13"	5000
XDFN2, 1x0.6, 0.65P (SOD-882)	711AM	SOD882	8 mm	4 mm	Top left Top right	178 mm	7"	8000
		DO35A	64 mm					
	318	MA03D	8 mm	4 mm	Bottom left	178 & 330 mm	7" & 13"	3000

Orientation Guide for Commonly Used Devices

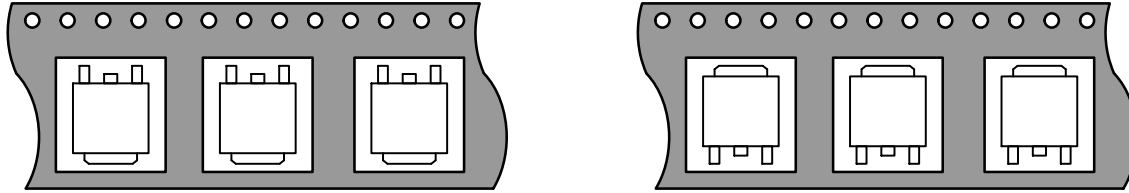


Product Orientation

Direction of Feed



Figure 1. D²PAK (TO-263)
24 mm (Tape Width, Typical)



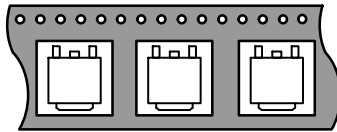
5 Lead – T4 Discrete
R4, R5 Analog

7 Lead – R7 Analog
PowerFLEX-7 – R7 Analog

3 Lead – T4 Discrete
R3, R4 Analog

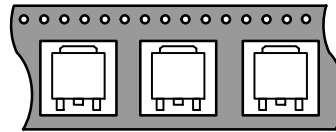
Discrete Suffix – T4 (TO-263)

Figure 2. DPAK
16 mm



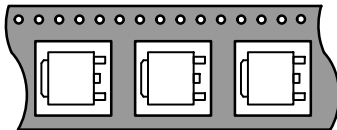
Discrete Suffix – T4
Analog Suffix – R or RK

Figure 3. DPAK
16 mm



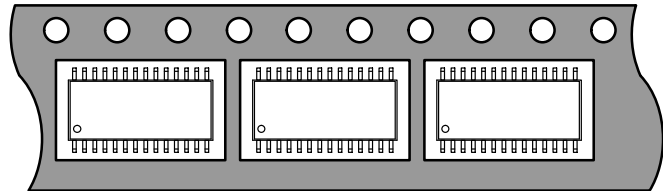
Discrete, Analog
Suffix – T5
TP- FA, DPAK (Single Gauge) – T4

Figure 4. DPAK
16 mm



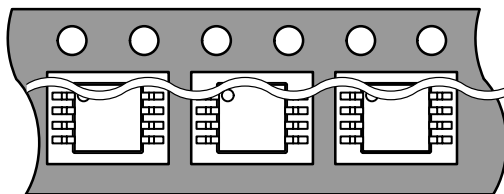
Discrete Suffix – RL

Figure 5. SO-28W
32 mm



R3 – Analog

Figure 6. Micro8™ / Micro10 / SO / SOIC / SOIC-EIAJ / SOP / SSOP / TSSOP



Pin 1 (Upper Left)

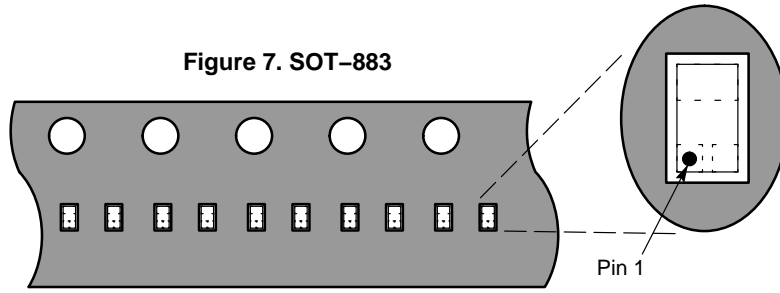
EL – Logic
R or R2 – Analog
R2 – Discrete
R2 – Clock & Data Mgt.
T2 or T3 – EEPROM

Product Orientation (continued)

Direction of Feed

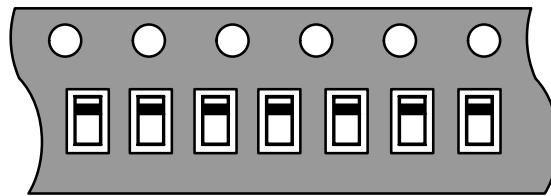


Figure 7. SOT-883



"T5" Pin One Opposing Sprocket Hole (8k Reel)

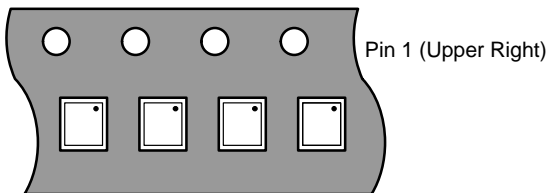
Figure 8. DSN



Die orientation in tape with pads down
"T5" Pin One Towards Sprocket Hole (5k Reel)

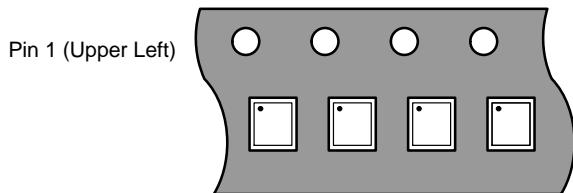
Figure 9. WLCSP, Flip-Chip/DCA

Option 1, 3



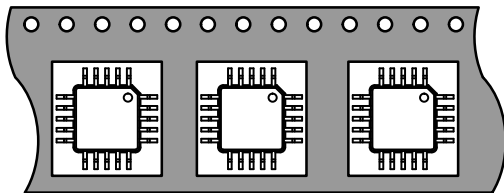
Die orientation in tape with bumps down
"T1" Pin One Towards Sprocket Hole (3k Reel)
"T3" Pin One Towards Sprocket Hole (10k Reel)

Option 2, 4



Die orientation in tape with bumps down
"T2" Pin One Towards Sprocket Hole (3k Reel)
"T4" Pin One Towards Sprocket Hole (10k Reel)

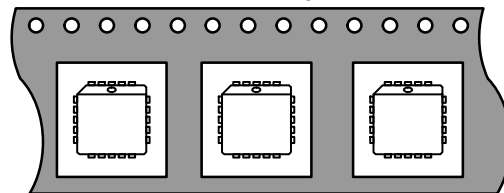
Figure 10. LQFP, TQFP



Pin 1 (Upper Right)
R2, R48 – Analog
R2 – Clock & Data Mgt.

Figure 11. PLCC

PLCC-20	PLCC-28	PLCC-44,	PLCC-68,
16 mm	24 mm	PLCC-52	PLCC-84
		32 mm	44 mm



Pin 1 (Upper Center)
R2, R28, R44 – Analog
R2 – Clock & Data Mgt.

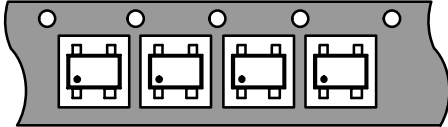
Product Orientation (continued)

Direction of Feed



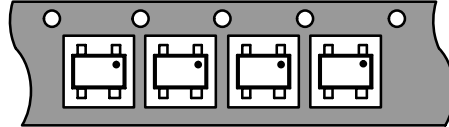
Figure 12. SC-82 / SC-82AB

"TR" Suffix – Option 1, 3



"T1" Pin One Opposing Sprocket Hole (3k Reel)
"T3" Pin One Opposing Sprocket Hole (10k Reel)

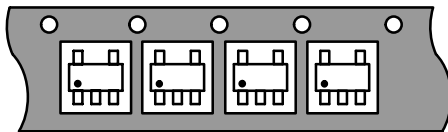
Figure 13. SC-82FL



"T1" Pin One Taped at Upper Right Position

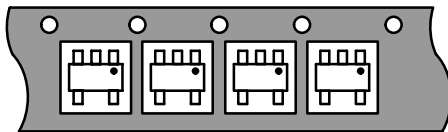
Figure 14. TSOP-5 / SOT23-5 / SC-74A

"T" or "TR" Suffix – Option 1, 3



"T1" Pin One Opposing Sprocket Hole (3k Reel)
"T3" Pin One Opposing Sprocket Hole (10k Reel)

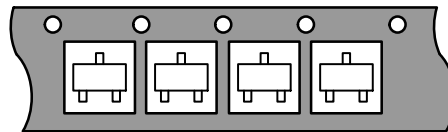
Option 2



"T2" Pin One Toward Sprocket Hole (3k Reel)

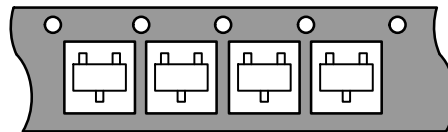
Figure 15. CPH3 / SOT-23 / SOT-23L / SOT-323 / SOT-623 / SC-59 / SC-70 / SC-70FL / SC-75 / SC-89

"T5", "TR" or "R2" Suffix – Option 1, 3



"T1" Single Lead Toward Sprocket Hole (3k Reel)
"T5" Single Lead Toward Sprocket Hole (8k Reel)
"T3" Single Lead Toward Sprocket Hole (8k, 10k Reel)

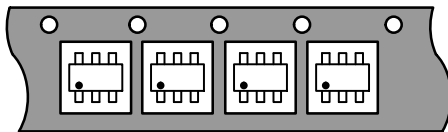
Option 2



"T2" Single Lead Opposing Sprocket Hole (3k Reel)
(This Orientation Applies to SC-59 Only)

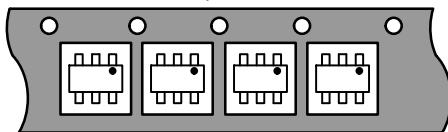
Figure 16. TSOP-6 / SOT23-6 / SC-74

"T" or "TR" Suffix – Option 1, 3



"T1" Pin One Opposing Sprocket Hole (3k Reel)
"T3" Pin One Opposing Sprocket Hole (10k Reel)

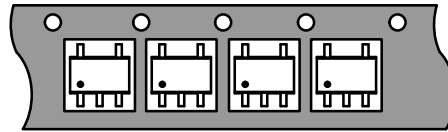
Option 2



"T2" Pin One Toward Sprocket Hole (3k Reel)

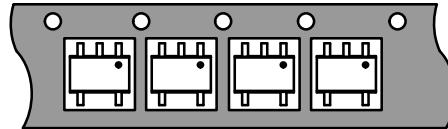
Figure 17. SC-88A / SC-88AFL / SC70-5 / SOT-353

Option 2, 4



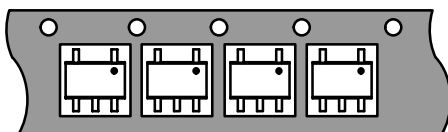
"T2" Pin One Opposing Sprocket Hole (3k Reel)
"T4" Pin One Opposing Sprocket Hole (10k Reel)

Option 1, 3



"T1" Pin One Toward Sprocket Hole (3k Reel)
"T3" Pin One Toward Sprocket Hole (10k Reel)

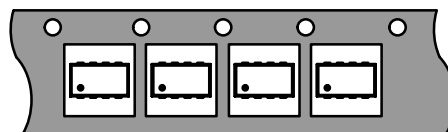
Figure 18. CPH4 / CPH5



"T1" Pin One Taped at Upper Right Position

Figure 19. ChipFET (8-Lead)

"T1" Suffix – Option 1



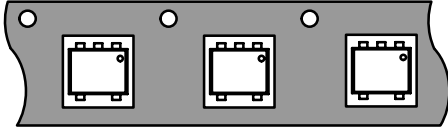
"T1" Pin One Opposing Sprocket Hole (3k Reel)

Product Orientation (continued)

Direction of Feed

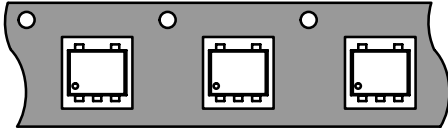


Figure 20. SOT-553
Option 1



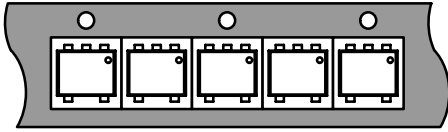
"T1" Pin One Toward Sprocket Hole (4k Reel)

Option 2



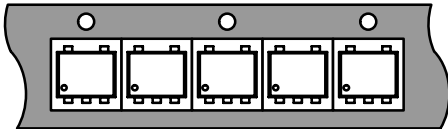
"T2" Pin One Opposing Sprocket Hole (4k Reel)

Option 5



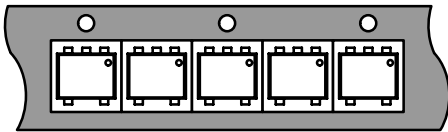
"T5" Pin One Toward Sprocket Hole (8k Reel)

Option 6



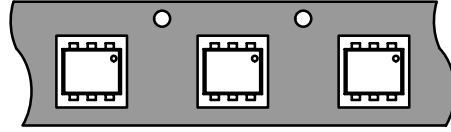
"T6" Pin One Opposing Sprocket Hole (8k Reel)

Figure 22. SOT-953
Option 5



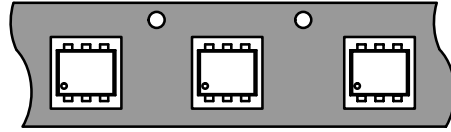
"T5" Pin One Toward Sprocket Hole (8k Reel)

Figure 21. SOT-563
Option 1



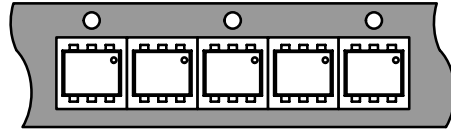
"T1, T3" Pin One Toward Sprocket Hole (5k Reel)

Option 2



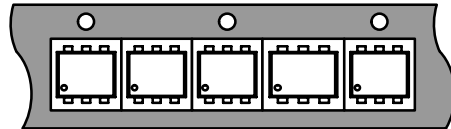
"T2" Pin One Opposing Sprocket Hole (4k Reel)

Option 5



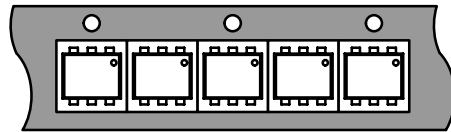
"T5" Pin One Toward Sprocket Hole (8k Reel)

Option 6



"T6" Pin One Opposing Sprocket Hole (8k Reel)

Figure 23. SOT-963
Option 5



"T5" Pin One Toward Sprocket Hole (8k Reel)

Figure 24. POWERMITE®
"T1" Suffix – Option 1

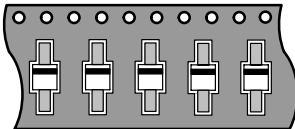
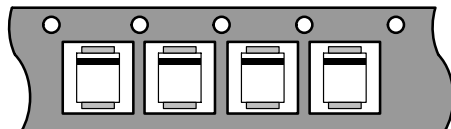


Figure 25. SMA, SMB, SMC
"TR" or "R2" Suffix – Option 1, 3



Unidirectional

SMA: "T1" Cathode Toward Sprocket Hole (1.5k Reel)
"T3" Cathode Toward Sprocket Hole (5k Reel)

SMB/SMC: "T1" Cathode Toward Sprocket Hole (1k Reel)
"T3" Cathode Toward Sprocket Hole (2.5k Reel)

Bidirectional

Same as above except no orientation

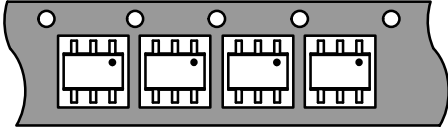
Product Orientation (continued)

Direction of Feed



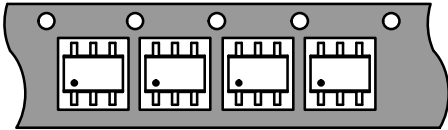
Figure 26. SC-88 / SC-88FL / SC70-6 / SOT-363 / CPH6

Option 1, 3



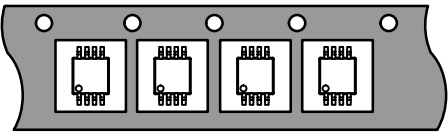
"T1" Pin One Toward Sprocket Hole (3k Reel)
 "T3" Pin One Toward Sprocket Hole (10k Reel)

Option 2



"T2" Pin One Opposing Sprocket Hole (3k Reel)

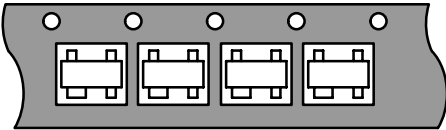
Figure 28. ULTRA SMALL 8



Pin One Opposing Sprocket Hole (3k Reel)

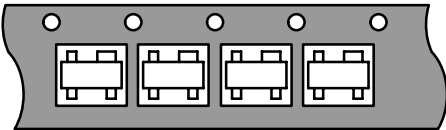
Figure 29. SOT-143

"T" or "TR" Suffix - Option 1, 3



"T1" Wide Lead Tape Opposing Sprocket Hole (3k Reel)
 "T3" Wide Lead Tape Opposing Sprocket Hole (10k Reel)

Option 2, 4



"T2" Wide Lead Tape Toward Sprocket Hole (3k Reel)
 "T4" Wide Lead Tape Toward Sprocket Hole (10k Reel)

Figure 31. SON-6

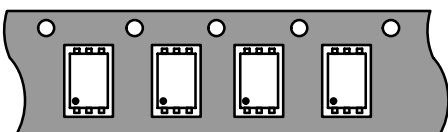
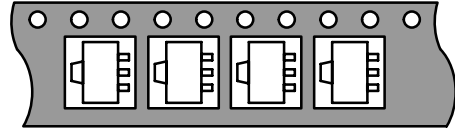


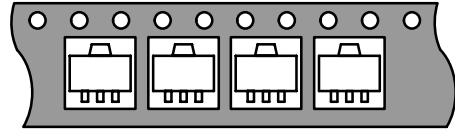
Figure 27. SOT-89

"R1" Suffix



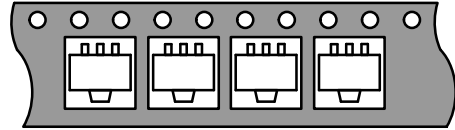
"R1" Pin One Opposing Sprocket Holes (1k Reel)

"T1" Suffix



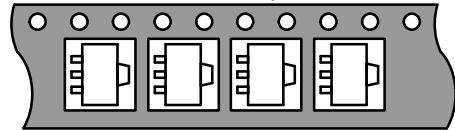
"T1" Single Lead Toward Sprocket Holes (1k Reel)

"T2" Suffix



"T2" Single Lead Away From Sprocket Holes (1k Reel)

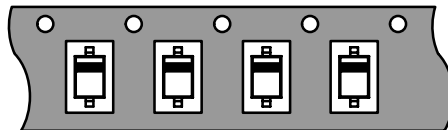
"T2" Suffix - Option 2



"T2" Single Lead Opposing Sprocket Holes (1k Reel)

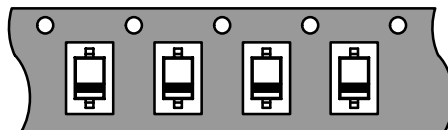
Figure 30. SOD-123 / SOD-323

Option 1, 3



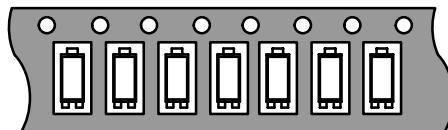
"T1" Cathode Lead Toward Sprocket Hole (3k Reel)
 "T3" Cathode Lead Toward Sprocket Hole (10k Reel)

Option 2



"T2" Cathode Lead Opposing Sprocket Hole (3k Reel)

Figure 32. SOT-1123



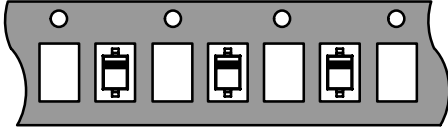
"T5" Single Lead Toward Sprocket Hole (8k Reel)

Product Orientation (continued)

Direction of Feed

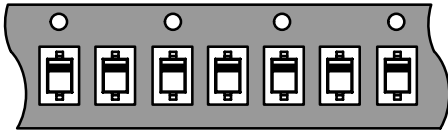


Figure 33. SOD-523
Option 1



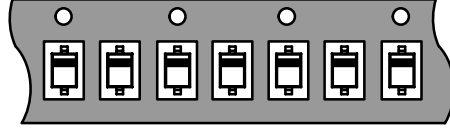
"T1" Cathode Lead Toward Sprocket Hole (3k Reel)

Option 5



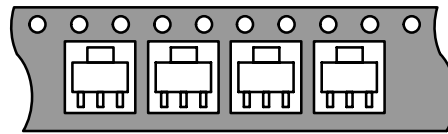
"T5" Cathode Lead Toward Sprocket Hole (8k Reel)

Figure 34. SOD-723, SOD-923
Option 5



"T5" Cathode Lead Toward Sprocket Hole (8k Reel)

Figure 35. SOT-223

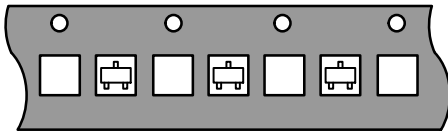


"T1" Single Lead Toward Sprocket Hole (1k Reel)

"T3" Single Lead Toward Sprocket Hole (4k Reel)

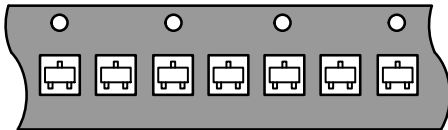
"R3" Single Lead Toward Sprocket Hole (2.5k Reel)

Figure 36. SOT-723
Option 1



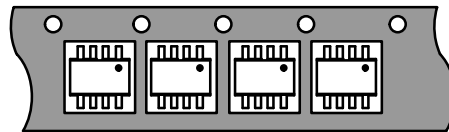
"T1" Single Lead Toward Sprocket Hole (4k Reel), 4mm pitch
(unit between two sprocket holes)

Option 2



"T5" Single Lead Toward Sprocket Hole (8k Reel), 2mm pitch

Figure 37. SOT-28FL / SOT-383FL



"T1" Pin One is Upper Right Position

Product Orientation (continued)

Direction of Feed



Leadless Packages

Figure 38. X3DFN

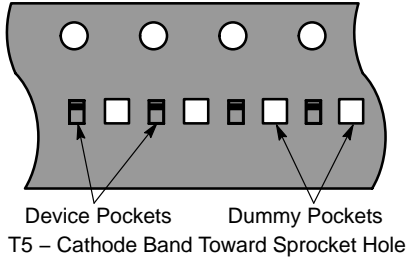


Figure 39. XLLGA, DFN

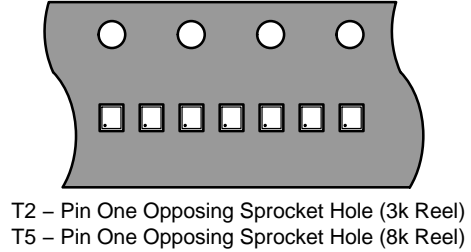


Figure 40. FCBGA (BGA)

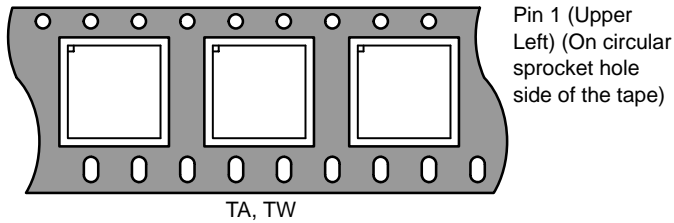
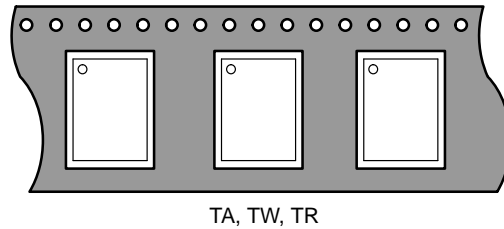
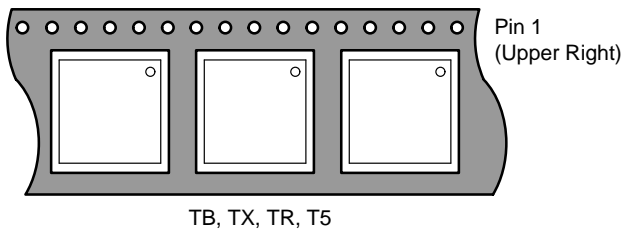


Figure 41. DFN/QFN/WLCSP-5



**Figure 42. DFN/QFN (LPCC)/
WLCSP-4/XDFN2**



**Figure 43. WLCSP 3-, 4-, 6-, 8-,
10-, & 12-Bump**

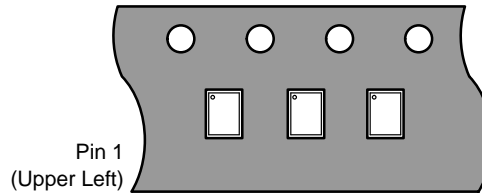


Figure 44. SIP

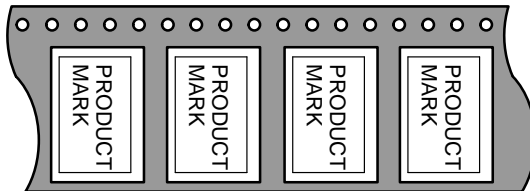
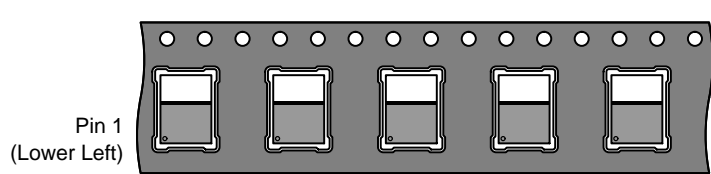


Figure 45. SIP51 (8x6)



Package	Pre Jan 2007	Post Jan 2007
DFN / QFN Square (LPCC)	T1	TB, TX
	T4	TB, TX
	R2	TB, TX
DFN / QFN Rectangular (LPCC)	T1	TA, TW
	R2	TA, TW
DFN / QFN	T2	TA, TW
	R2	TA, TW
FCBGA / BGA	R2	TA, TW
WLCSP	-	TR

Leadless Package Pin 1 Orientation for Tape and Reel (QFN, DFN, FCBGA, BGA, LPCC)

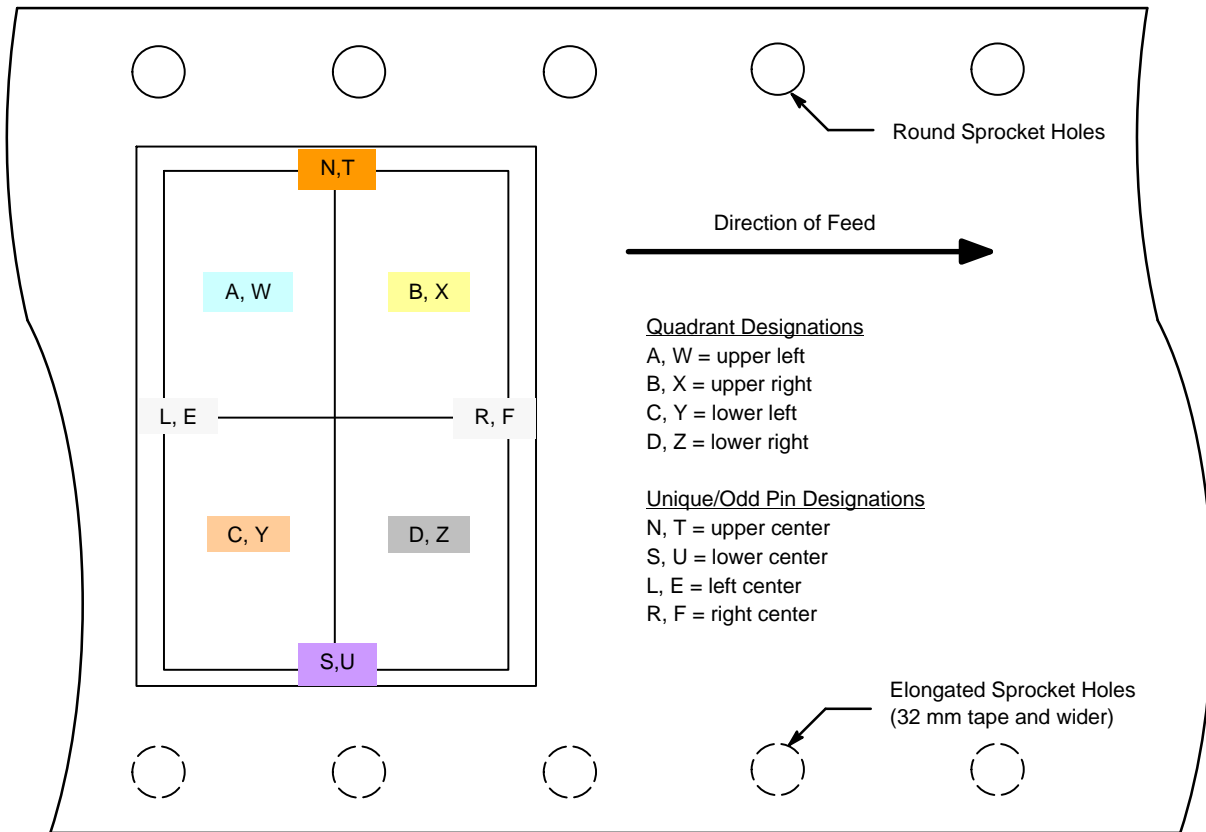
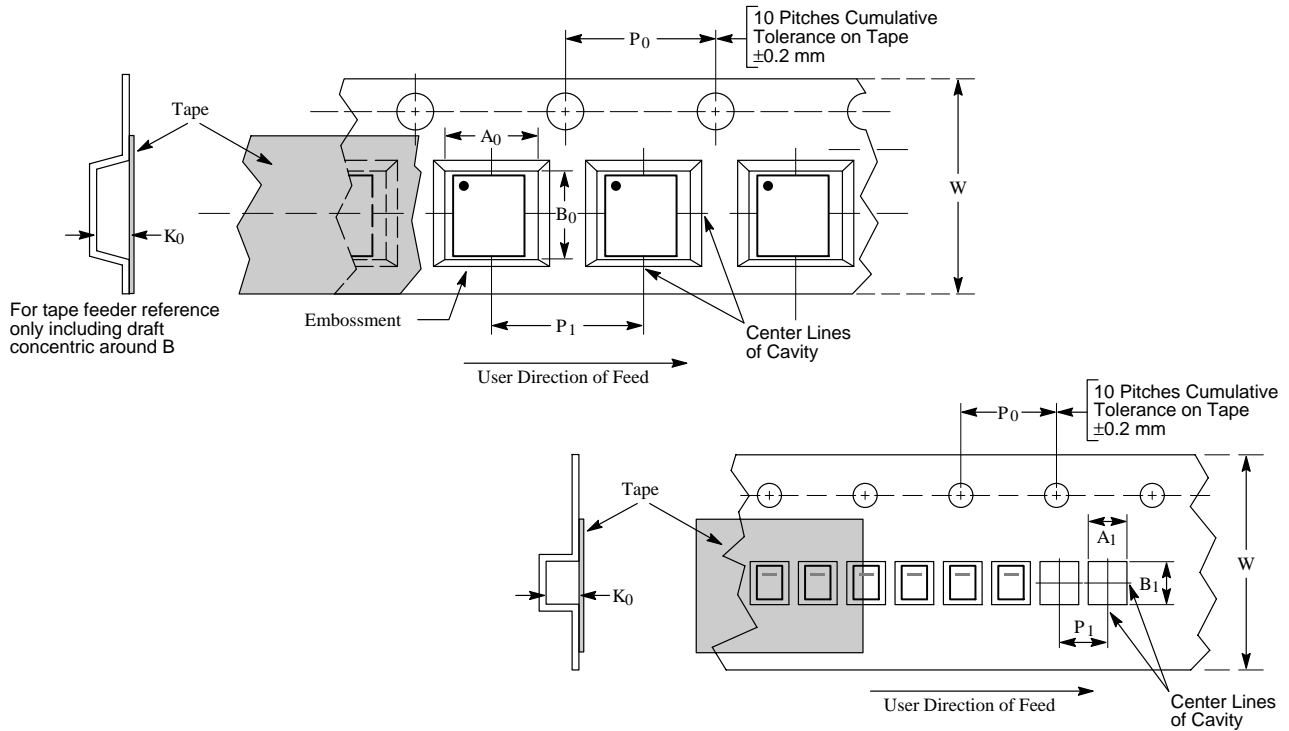


Figure 46. Leadless Package Pin 1 Orientation for Tape and Reel (Effective January 2007)

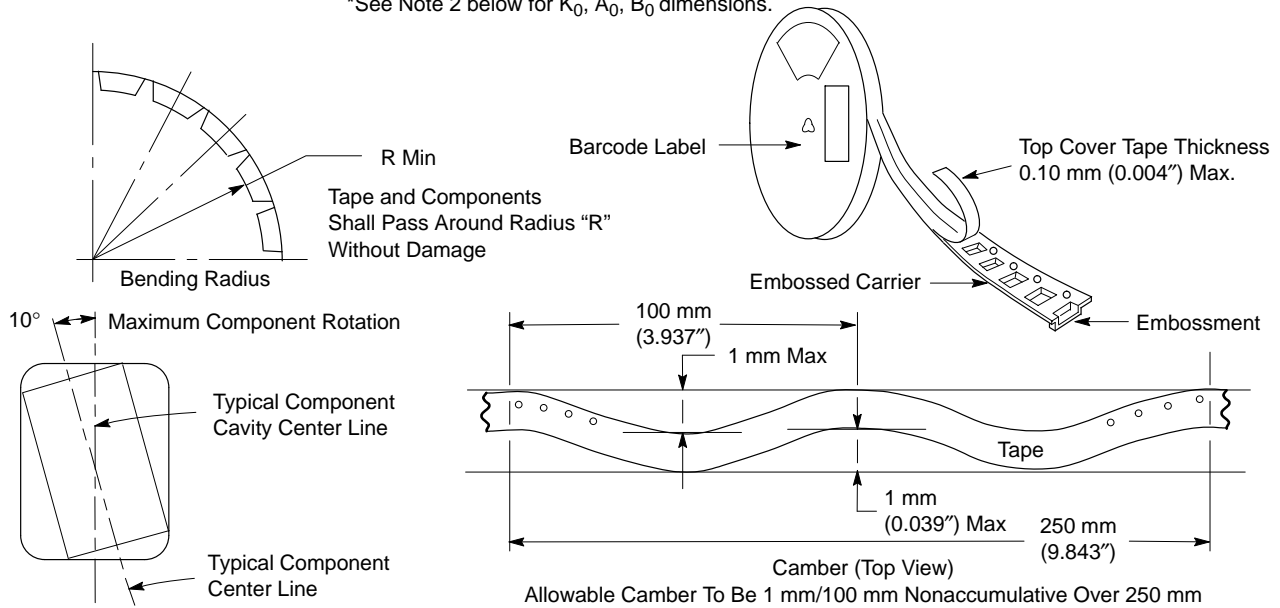
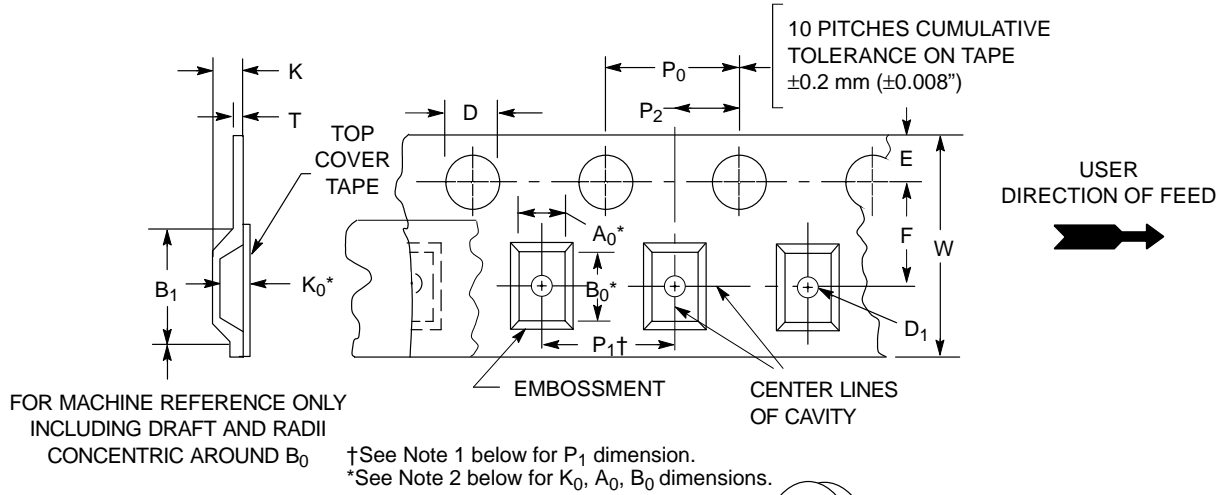
Part Number Suffix				
Shipping Type*	Pin1 Location	Blank or Pb-Free	Remark:	Reel Size (mm) diameter
T	A	G	Quadrant 1--upper left	177
T	B	G	Quadrant 2--upper right	178
T	C	G	Quadrant 3--lower left	178
T	D	G	Quadrant 4--lower right	178
T	W	G	Quadrant 1--upper left	330
T	X	G	Quadrant 2--upper right	330
T	Y	G	Quadrant 3--lower left	330
T	Z	G	Quadrant 4--lower right	330
T	N	G	North (upper center)	178
T	S	G	South (lower center)	178
T	T	G	Top (upper center)	330
T	U	G	Under (lower center)	330
T	L	G	Left center	178
T	R	G	Right center	178
T	E	G	Left center	330
T	F	G	Right center	330

*T = Tape

Tape and Reel Dimensions and Orientation for Former CMD Devices



Embossed Tape and Reel Data Carrier Tape Standards



DIMENSIONS

Tape Size (W)	B_1 Max (Note 1)	D	D_1	E	F	K	P_0	P_2	R Min	T Max	W Max
8 mm	4.55 mm (0.179")	1.5 ± 0.1 mm - 0.0 (0.059 + 0.004" - 0.0)	1.0 Min (0.039") or 0.5 mm Min (0.020") or 0.2 mm Min (0.008")	1.75 ± 0.1 mm (0.069 ± 0.004")	3.5 ± 0.05 mm (0.138 ± 0.002")	2.4 mm Max (0.094")	4.0 ± 0.1 mm (0.157 ± 0.004")	2.0 ± 0.1 mm (0.079 ± 0.002")	25 mm (0.98")	0.6 mm (0.024")	8.3 mm (0.327")
12 mm	8.2 mm (0.323")		1.5 mm Min (0.060")		5.5 ± 0.05 mm (0.217 ± 0.002")	6.4 mm Max (0.252")			30 mm (1.18")		12 ± 0.30 mm (0.470 ± 0.012")
16 mm	12.1 mm (0.476")				7.5 ± 0.10 mm (0.295 ± 0.004")	7.9 mm Max (0.311")					16.3 mm (0.642")
24 mm	20.1 mm (0.791")				11.5 ± 0.1 mm (0.453 ± 0.004")	11.9 mm Max (0.468")					24.3 mm (0.957")

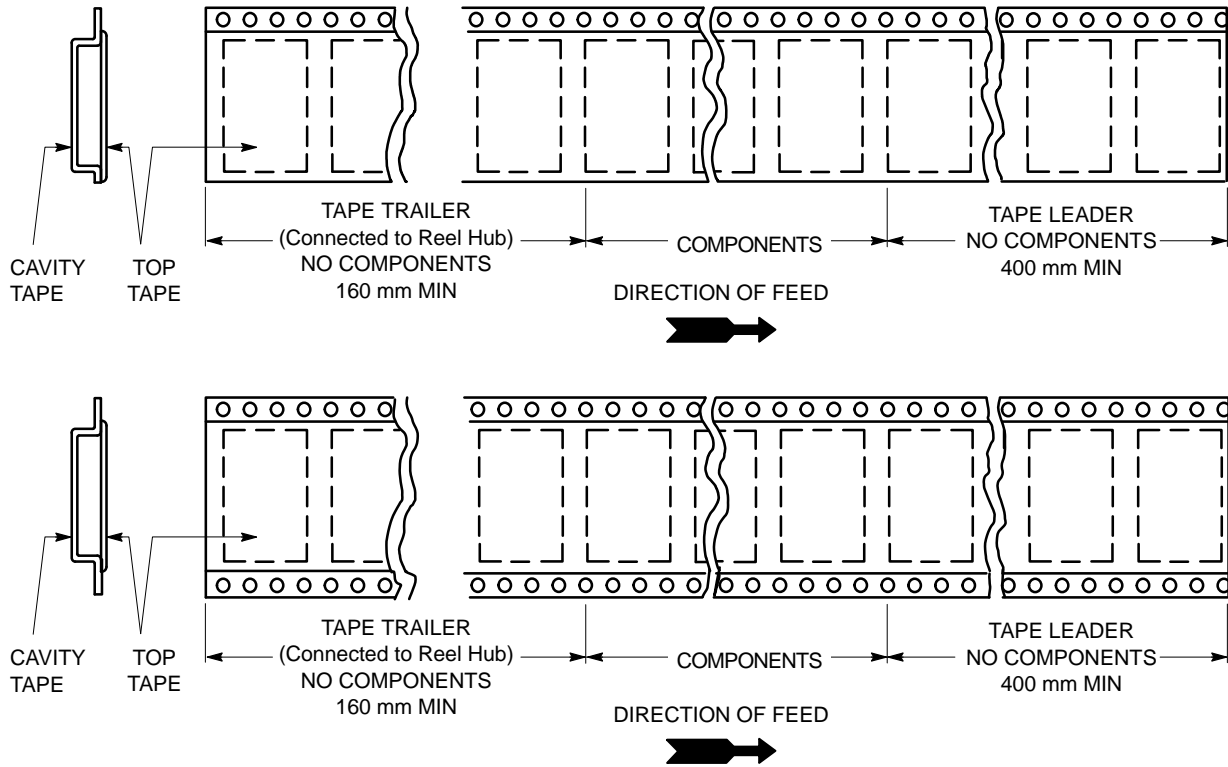
Metric dimensions govern – English are in parentheses for reference only.

- Pitch information (dimension P_1) is contained in the embossed tape and reel ordering information beginning on Page 5.
- A_0 , B_0 , and K_0 are determined by component size. The clearance between the components and the cavity must be within 0.05 mm min to 0.50 mm max. The component cannot rotate more than 10° within the determined cavity.

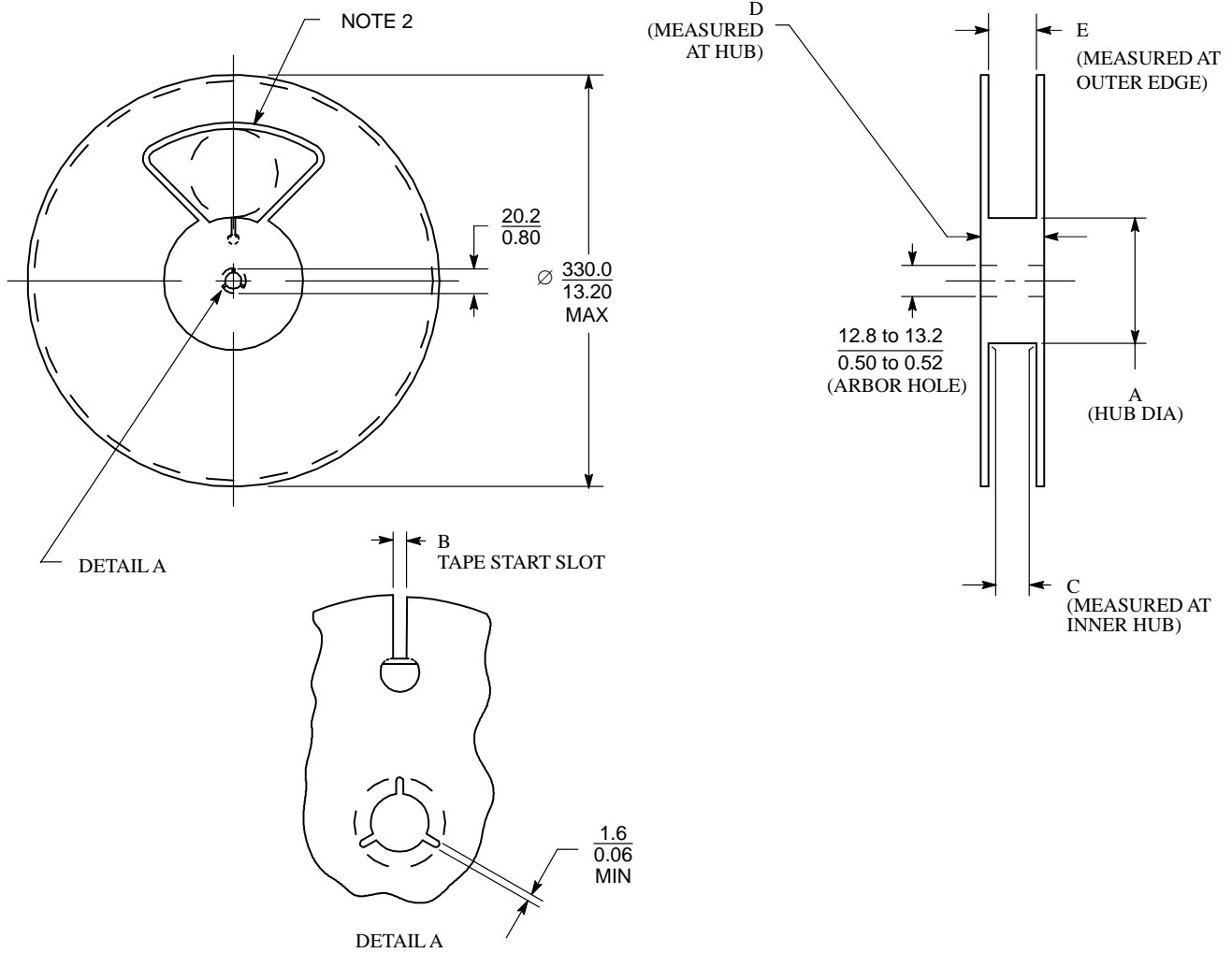
Tape Ends for Finished Goods

Leader and Trailer

The TRAILER is a minimum of 160 mm in length and it consists of empty cavities with sealed cover tape.
The LEADER is a minimum of 400 mm in length and it consists of empty cavities with sealed cover tape.



Reel Dimensions



Reel Diameter	Tape Size	A mm (inches)		B mm (inches)		C mm (inches)		D (Max)	E (Max)
		Min	Max	Min	Max	Min	Max		
178.0 (7.01)	16.0 (0.63)		50.0 (1.97)	6.5 (0.26)	7.5 (0.30)	16.4 (0.65)	18.4 (0.72)	22.4 (0.88)	19.4 (0.76)
330.0 (12.99)	12.0 (0.47)	178.0 (7.01)		4.5 (0.18)	5.5 (0.22)	12.4 (0.49)	14.4 (0.57)	18.4 (0.72)	15.4 (0.61)
330.0 (12.99)	56.0 (2.20)	150.0 (5.91)		10.0 (0.39)	11.0 (0.43)	56.4 (2.22)	58.4 (2.30)	62.4 (2.46)	59.4 (2.34)
330.0 (12.99)	44.0 (1.73)	100.0 (3.94)		10.0 (0.39)	11.0 (0.43)	44.4 (1.75)	46.4 (1.83)	62.4 (2.46)	47.4 (1.87)
330.0 (12.99)	32.0 (1.26)	100.0 (3.94)		10.0 (0.39)	11.0 (0.43)	32.4 (1.28)	34.4 (1.35)	38.4 (1.51)	35.4 (1.39)
330.0 (12.99)	24.0 (0.94)	60.0 (2.36)		9.5 (0.37)	10.5 (0.41)	24.4 (0.96)	26.4 (1.04)	30.4 (1.51)	27.4 (1.08)
330.0 (12.99)	16.0 (0.63)			6.5 (0.26)	7.5 (0.30)	16.4 (0.65)	18.4 (0.72)	22.4 (0.88)	19.4 (0.76)
330.0 (12.99)	12.0 (0.47)			4.5 (0.18)	5.5 (0.22)	12.4 (0.49)	14.4 (0.57)	18.4 (0.72)	15.4 (0.61)
330.0 (12.99)	8.0 (0.31)	50.0 (1.97)		2.5 (0.10)	3.5 (0.14)	8.4 (0.33)	9.9 (0.39)	14.4 (0.57)	10.9 (0.43)
178.0 (7.01)	12.0 (0.47)	50.0 (1.97)		4.5 (0.18)	5.5 (0.22)	12.4 (0.49)	14.4 (0.57)	18.4 (0.72)	15.4 (0.61)
178.0 (7.00)	8.0 (0.31)	50.0 (1.97)		2.5 (0.10)	3.5 (0.14)	8.4 (0.33)	9.9 (0.39)	14.4 (0.47)	10.9 (0.43)
330.0 (12.99)	8.0 (0.31)	50.0 (1.97)		4.0 (0.16)	5.0 (0.20)	8.4 (0.33)	9.9 (0.39)	14.4 (0.57)	10.9 (0.43)
178.0 (7.00)	8.0 (0.31)	50.0 (1.97)		4.0 (0.16)	5.0 (0.20)	8.4 (0.33)	9.9 (0.39)	14.4 (0.57)	10.9 (0.43)

Reel Dimensions (continued)

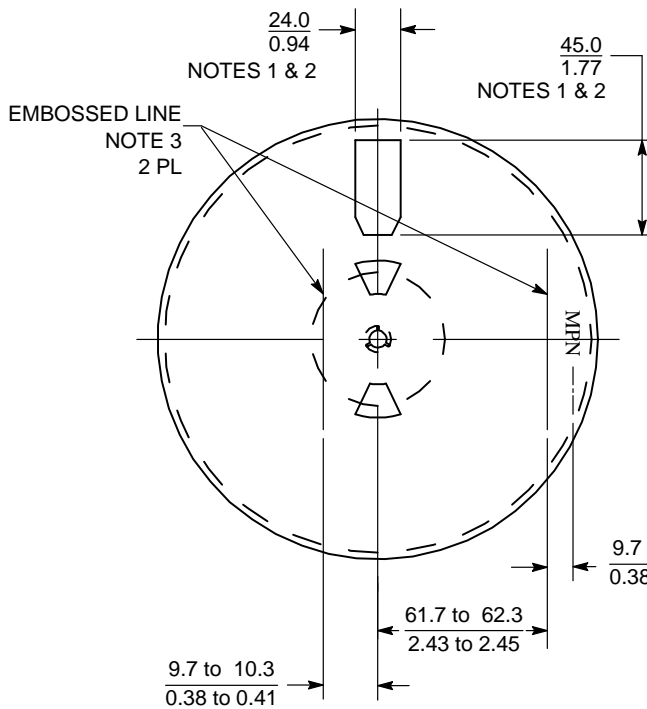


Figure 47. Front View of 178 mm (7.0 in) Reel

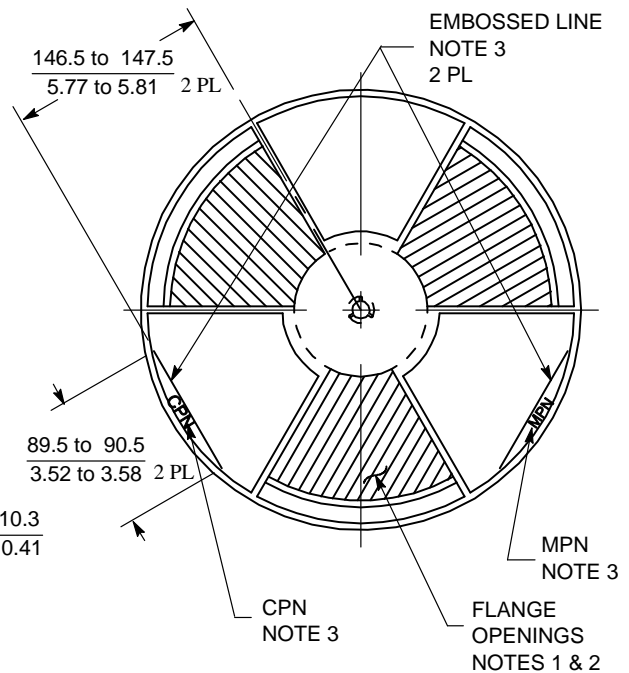


Figure 48. Front View of 330 mm (12.99 in) Reel

NOTES:

1. LABEL PLACEMENT AREA:

- All reels must have flat area on the front flange of the reel that will fit two 41.3 mm (1.65 in) by 125 mm (4.90 in) ON Semiconductor barcode labels.
- If there are any flange openings on the front side of the 178 mm (7.00 in) reel they must be designed in locations so that two of the 41.3 mm (1.65 in) ON Semiconductor barcode labels can be applied parallel to each other as in Figure 47.
- If there are any flange opening on the front flange of the 330 mm (13.0 in) reel they must be designed in locations so that two of the 41.3 mm (1.65 in) by 125 mm (4.90 in) ON Semiconductor barcode labels can be applied parallel to each other as in Figure 48.

2. FLANGE OPENINGS

- Flange opening on the front and the back of the reel are a supplier option but must meet all of the requirements in Note 1. The preferred size for the 176 mm (7.0 in) reel is shown in Figure 47.
- The tape loading opening must be as in Detail A.

3. GRAPHICS:

- The letters MPN and CPN are an option. The size and thickness of the letters are the manufacturer's option and are not to be used for inspection criteria.
- The embossed lines on the reel are an option. If the lines are used they must be located as in Figure 47 and 48. They must be a minimum 38 mm (1.50 in) long. The thickness is a manufacturer's option and not to be used for inspection criteria.

Reel Labeling

Place the reel on an ESD protective surface so that the round sprocket holes are on the bottom. The direction of travel when unwound should be from the top right quadrant. See illustration below.

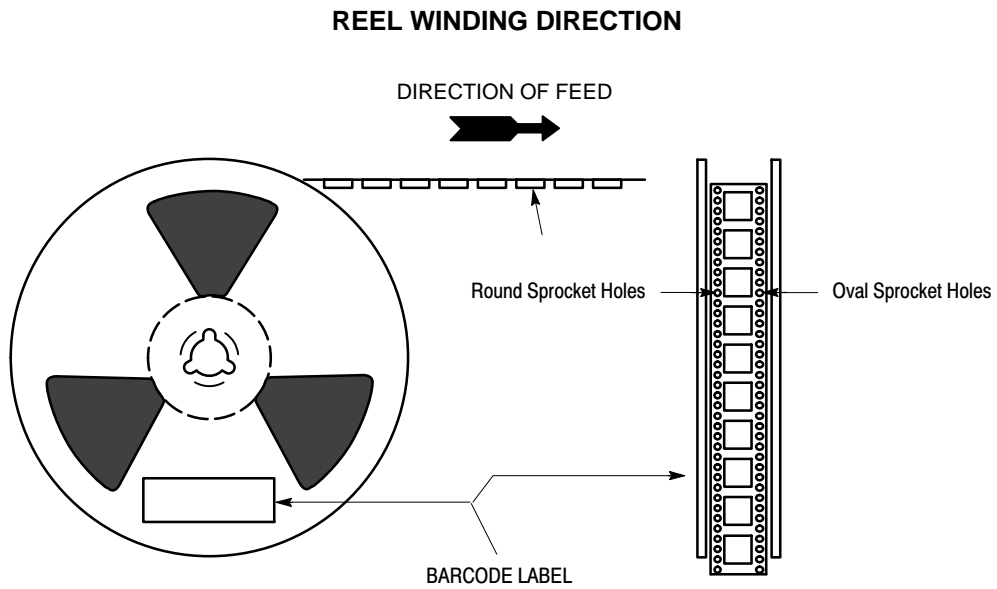


Figure 49. Round and Oval Sprocket Holes Used with 32 mm, 42 mm, 44 mm and 52 mm Tape (holes on both sides)

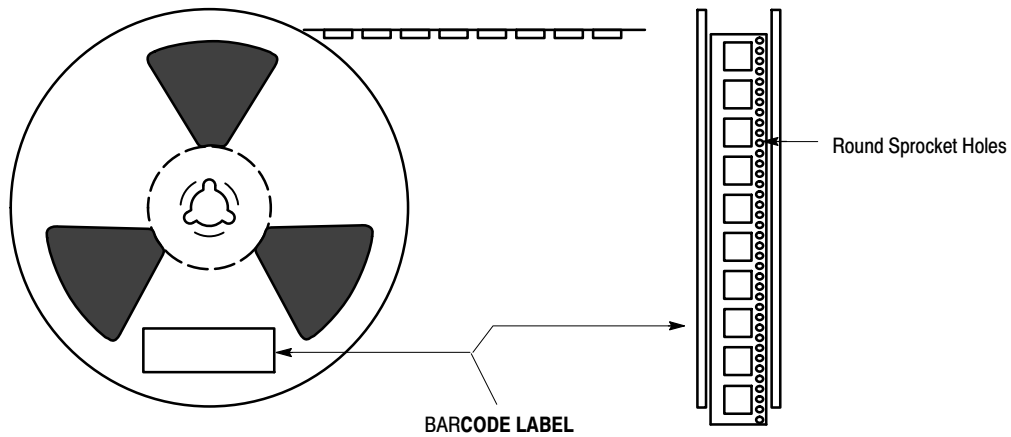
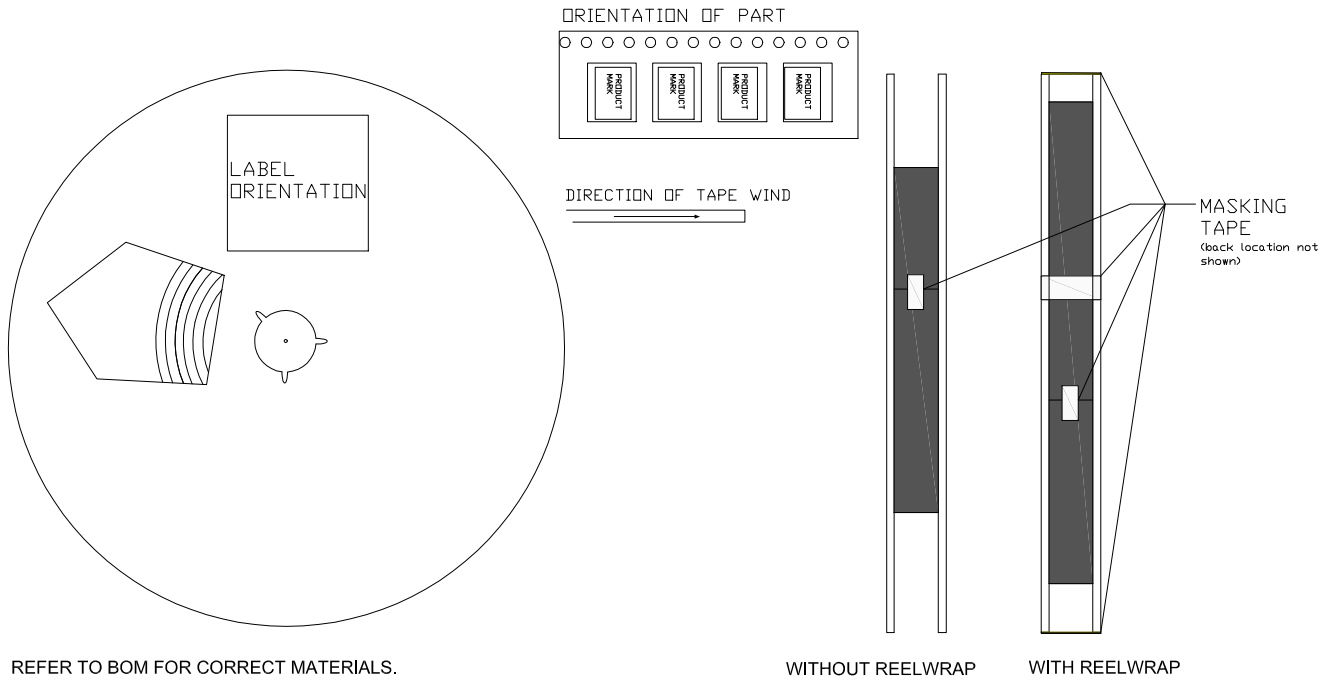


Figure 50. Round Sprocket Holes Used with 8 mm, 12 mm, 16 mm and 24 mm Tape (holes on one side only)

REEL ORIENTATION FOR LGA, SIP PACKAGES



REFER TO BOM FOR CORRECT MATERIALS.

MASKING TAPE APPLIED IN 6 LOCATIONS:

- 1) SECURE CARRIER TAPE
- 2) SECURE REELWRAP
- 3-6) 4 LOCATIONS AROUND REEL TO FURTHER SECURE REELWRAP

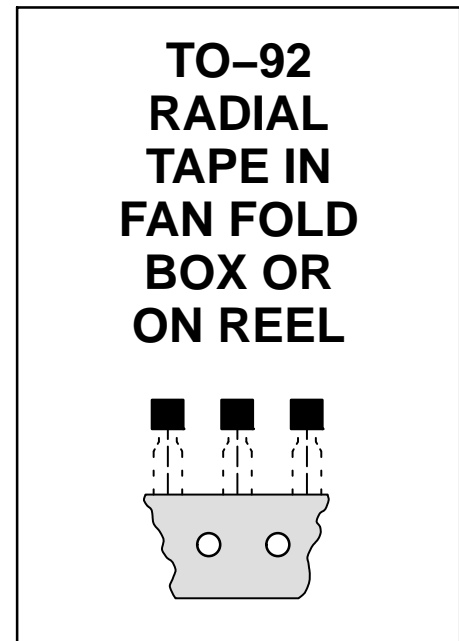
Figure 51. PRODUCT ORIENTATION FOR LGA, SIP PACKAGES

TO-92 EIA, IEC, EIAJ

Radial Tape in Fan Fold Box or On Reel

Radial tape in fan fold box or on reel of the reliable TO-92 package are the best methods of capturing devices for automatic insertion in printed circuit boards. These methods of taping are compatible with various equipment for active and passive component insertion.

- Available in Fan Fold Box
- Available on 365 mm Reels
- Accommodates All Standard Inserters
- Allows Flexible Circuit Board Layout
- 2.5 mm Pin Spacing for Soldering
- EIA-468, IEC 286-2, EIAJ RC1008B



Ordering Notes:

When ordering radial tape in fan fold box or on reel, specify the style per Figures 53, 54, 60 and 61. Add the suffix “RLR” and “Style” to the device title, i.e. 2N5060RLRA. This will be a standard 2N5060 radial taped and supplied on a reel. Some products only utilize the last 2 digits. Please refer to the ON Semiconductor device data sheet for exact ordering information.

- Fan Fold Box Information – Minimum order quantity 1 Box. Order in increments of 2000.
- Reel Information – Minimum order quantity 1 Reel. Order in increments of 2000.

US/EUROPEAN SUFFIX CONVERSIONS

U.S.	Europe	Package Style
RLRA, RA	RL	Reel
RLRE, RE	RL1	Reel
RLRM, RM	ZL1	Fan Fold
RLRP, RP	-	Fan Fold

TO-92 EIA RADIAL TAPE IN FAN FOLD BOX OR ON REEL

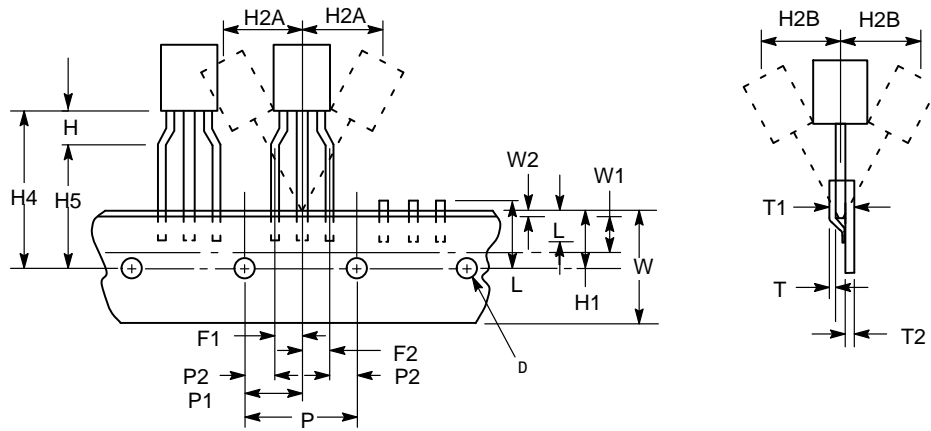


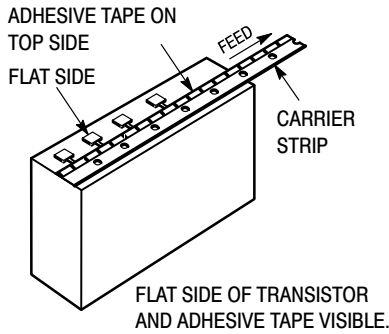
Figure 52. Device Positioning on Tape

Symbol	Item	Specification			
		Inches		Millimeter	
		Min	Max	Min	Max
D	Tape Feedhole Diameter	0.1496	0.1653	3.8	4.2
D2	Component Lead Thickness Dimension	0.015	0.020	0.38	0.51
F1, F2	Component Lead Pitch	0.0945	0.110	2.4	2.8
H	Bottom of Component to Seating Plane	0.059	0.156	1.5	4.0
H1	Feedhole Location	0.3346	0.3741	8.5	9.5
H2A	Deflection Left or Right	0	0.039	0	1.0
H2B	Deflection Front or Rear	0	0.051	0	1.0
H4	Feedhole to Bottom of Component	0.7086	0.768	18	19.5
H5	Feedhole to Seating Plane	0.610	0.649	15.5	16.5
L	Defective Unit Clipped Dimension	0.3346	0.433	8.5	11
L1	Lead Wire Enclosure	0.09842	–	2.5	–
P	Feedhole Pitch	0.4921	0.5079	12.5	12.9
P1	Feedhole Center to Center Lead	0.2342	0.2658	5.95	6.75
P2	First Lead Spacing Dimension	0.1397	0.1556	3.55	3.95
T	Adhesive Tape Thickness	0.06	0.08	0.15	0.20
T1	Overall Taped Package Thickness	–	0.0567	–	1.44
T2	Carrier Strip Thickness	0.014	0.027	0.35	0.65
W	Carrier Strip Width	0.6889	0.7481	17.5	19
W1	Adhesive Tape Width	0.2165	0.2841	5.5	6.3
W2	Adhesive Tape Position	0.0059	0.01968	0.15	0.5

3. Maximum alignment deviation between leads not to be greater than 0.2 mm.
4. Defective components shall be clipped from the carrier tape such that the remaining protrusion (L) does not exceed a maximum of 11 mm.
5. Component lead to tape adhesion must meet the pull test requirements established in Figures 56, 57 and 58.
6. Maximum non-cumulative variation between tape feed holes shall not exceed 1 mm in 20 pitches.
7. Hold down tape not to extend beyond the edge(s) of carrier tape and there shall be no exposure of adhesive.
8. No more than 1 consecutive missing component is permitted.
9. A tape trailer and leader, having at least three feed holes is required before the first and after the last component.
10. Splices will not interfere with the sprocket feed holes.

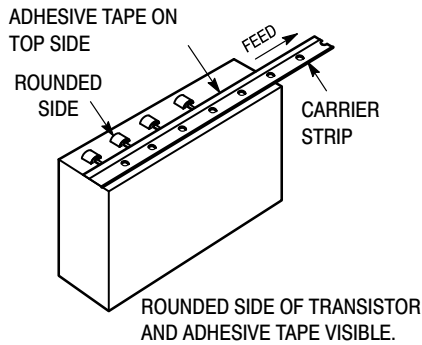
TO-92 EIA RADIAL TAPE IN FAN FOLD BOX OR ON REEL

FAN FOLD BOX STYLES



Style M fan fold box is equivalent to styles E and F of reel pack dependent on feed orientation from box.

Figure 53. Style RLRM, RM



Style P fan fold box is equivalent to styles A and B of reel pack dependent on feed orientation from box.

Figure 54. Style RL RP

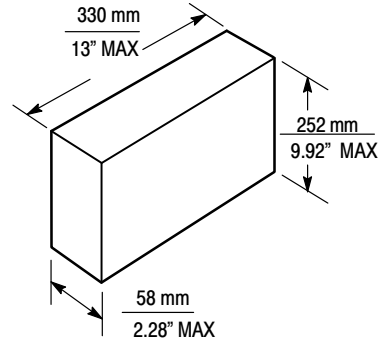
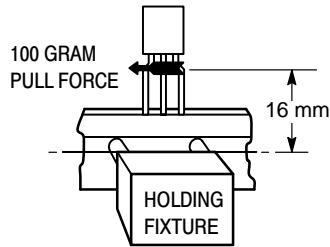


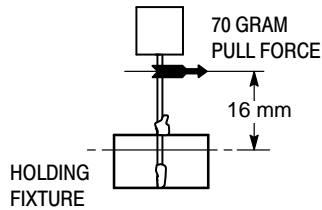
Figure 55. Fan Fold Box Dimensions

ADHESION PULL TESTS



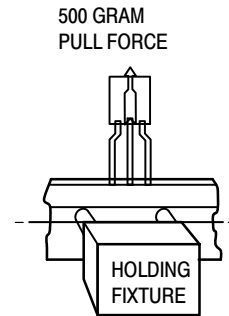
The component shall not pull free with a 300 gram load applied to the leads for 3 ± 1 second.

Figure 56. Test #1



The component shall not pull free with a 70 gram load applied to the leads for 3 ± 1 second.

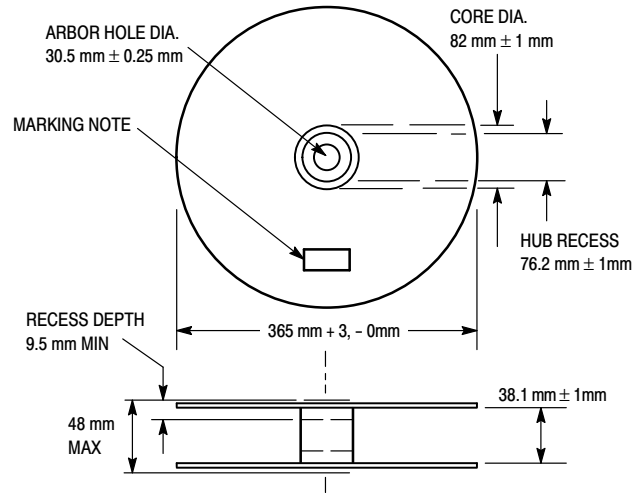
Figure 57. Test #2



There shall be no deviation in the leads and no component leads shall be pulled free of the tape with a 500 gram load applied to the component body for 3 ± 1 second.

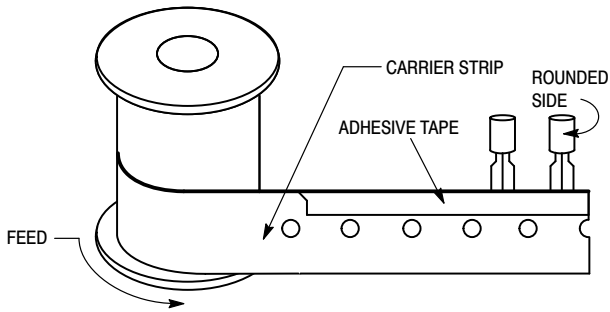
Figure 58. Test #3

TO-92 EIA RADIAL TAPE IN FAN FOLD BOX OR ON REEL: REEL STYLES



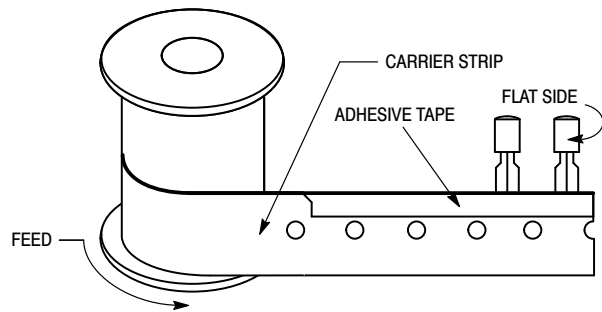
Material used must not cause deterioration of components or degrade lead solderability

Figure 59. Reel Specifications



Rounded side of transistor and adhesive tape visible.

Figure 60. Style RLRA, RA



Flat side of transistor and adhesive tape visible.

Figure 61. Style RLRE, RE

Lead Tape Packaging Standards for Axial-Lead Components

1.0 SCOPE

This section covers packaging requirements for the following axial-lead component's use in automatic testing and assembly equipment: ON Semiconductor Case 17-02, Case 41A-02, Case 51-02 (DO-7), Case 59-03 (DO-41), Case 59-04, Case 194-04 and Case 299-02 (DO-35). Packaging, as covered in this section, shall consist of axial-lead components mounted by their leads on pressure sensitive tape, wound onto a reel.

2.0 PURPOSE

This section establishes ON Semiconductor standard practices for lead-tape packaging of axial-lead components and meets the requirements of EIA Standard RS-296-D "Lead-taping of Components on Axial Lead Configuration for Automatic Insertion," level 1.

3.0 REQUIREMENTS

3.1 Component Leads

3.1.1 – Component leads shall not be bent beyond dimension E from their normal position. See Figure 63.

3.1.2 – The "C" dimension shall be governed by the overall length of the reel packaged component. The distance between flanges shall be 0.059 inch to 0.315 inch greater than the overall component length. See Figures 63 and 64.

3.1.3 – Cumulative dimension "A" tolerance shall not exceed 0.059 over 6 in consecutive components.

3.2 Orientation

All polarized components must be oriented in one direction. The cathode lead tape shall be any color except white and the anode tape shall be white. See Figure 62.

3.3 Reeling

3.3.1 – Components on any reel shall not represent more than two date codes when date code identification is required.

3.3.2 – Component's leads shall be positioned perpendicularly between pairs of 0.250 inch tape. See Figure 63.

3.3.3 – A minimum 12 inch leader of tape shall be provided before the first and last component on the reel.

3.3.4 – 50 lb. Kraft paper is wound between layers of components as far as necessary for component protection.

3.3.5 – Components shall be centered between tapes such that the difference between D1 and D2 does not exceed 0.055.

3.3.6 – Staples shall not be used for splicing. No more than four layers of tape shall be used in any splice area and no tape shall be offset from another by more than 0.031 inch noncumulative. Tape splices shall overlap at least 6 inches for butt joints and at least 3 inches for lap joints and shall not be weaker than unspliced tape.

3.3.7 – Quantity per reel shall be as indicated in Table 1. Orders for tape and reeled product will only be processed and shipped in full reel increments. Scheduled orders must be in releases of full reel increments or multiples thereof.

3.3.8 – A maximum of 0.25% of the components per reel quantity may be missing without consecutive missing per level 1 of RS-296-D.

3.3.9 – The single face roll pad shall be placed around the finished reel and taped securely. Each reel shall then be placed in an appropriate container.

3.4 Marking

Minimum reel and carton marking shall consist of the following (see Figure 64):

ON Semiconductor part number

Quantity

Manufacturer's name

Date codes (when applicable; see note **3.3.1**)

4.0

Requirements differing from this ON Semiconductor standard shall be negotiated with the factory.

The packages indicated in the following table are suitable for lead tape packaging. Table 1 indicates the specific devices (transient voltage suppressors and/or Zeners) that can be obtained from ON Semiconductor in reel packaging and provides the appropriate packaging specification.

Lead Tape Packaging Standards for Axial-Lead Components

Table 1. PACKAGING DETAILS (all dimensions in inches)

Case Type	Product Category	Device Title Suffix	MPQ Quantity Per Reel	Component Spacing A Dimension	Tape Spacing B Dimension	Reel Dimension C	Reel Dimension D (Max)	Max Off Alignment E
Case 17	Surmetic 40 & 600 Watt TVS	RL	4000	0.2 ± 0.015	2.062 ± 0.059	3	14	0.047
Case 41A	1500 Watt TVS	RL4	1500	0.4 ± 0.02	2.062 ± 0.059	3	14	0.047
Case 59	DO-41 Glass & DO-41 Surmetic 30	RL	6000	0.2 ± 0.015	2.062 ± 0.059	3	14	0.047
	Rectifier							
Case 59	500 Watt TVS	RL	500	0.2 ± 0.02	2.062 ± 0.059	3	14	0.047
	Rectifier							
Case 194	110 Amp TVS (Automotive)	RL	800	0.4 ± 0.02	1.875 ± 0.059	3	14	0.047
	Rectifier							
Case 267	Rectifier	RL	1500	0.4 ± 0.02	2.062 ± 0.059	3	14	0.047
Case 299	DO-35 Glass	RL	5000	0.2 ± 0.02	2.062 ± 0.059	3	14	0.047
Case 267	Schottky & Ultrafast Rectifiers	RL	1500	0.4 ± 0.02	2.062 ± 0.059	3	14	0.047
Case 267	Fast Recovery & General Purpose Rectifiers	RL	1200	0.4 ± 0.02	2.062 ± 0.059	3	14	0.047

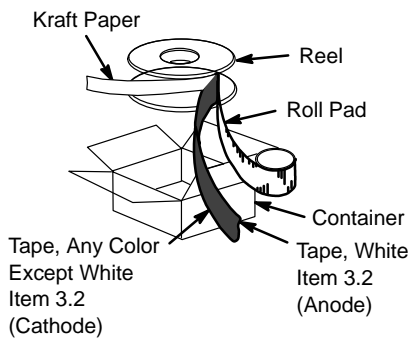


Figure 62. Reel Packing

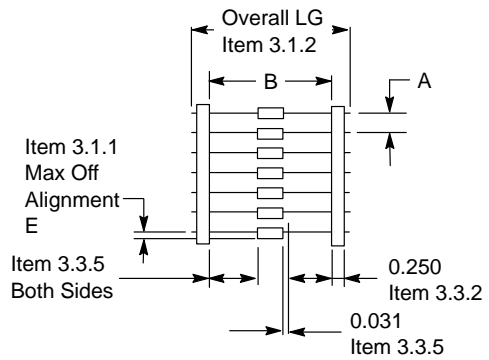


Figure 63. Component Spacing

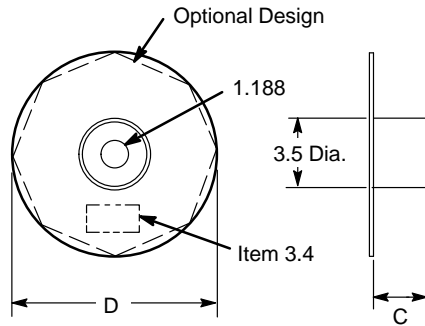


Figure 64. Reel Dimensions (Item references appear on Page 40)

INFORMATION FOR USING SURFACE MOUNT PACKAGES

RECOMMENDED FOOTPRINTS FOR SURFACE MOUNTED APPLICATIONS

Surface mount board layout is a critical portion of the total design. The footprint for the semiconductor packages must be the correct size to ensure proper solder connection

interface between the board and the package. With the correct pad geometry, the packages will self align when subjected to a solder reflow process.

POWER DISSIPATION FOR A SURFACE MOUNT DEVICE

The power dissipation for a surface mount device is a function of the drain/collector pad size. These can vary from the minimum pad size for soldering to a pad size given for maximum power dissipation. Power dissipation for a surface mount device is determined by $T_{J(max)}$, the maximum rated junction temperature of the die, $R_{\theta JA}$, the thermal resistance from the device junction to ambient, and the operating ambient temperature, T_A . Using the values provided on the data sheet, P_D can be calculated as follows:

$$P_D = \frac{T_{J(max)} - T_A}{R_{\theta JA}}$$

The values for the equation are found in the maximum ratings table on the data sheet. Substituting these values into the equation for an ambient temperature T_A of 25°C, one can calculate the power dissipation of the device. For example, for a SOT-223 device, P_D is calculated as follows.

$$P_D = \frac{150^\circ\text{C} - 25^\circ\text{C}}{156^\circ\text{C/W}} = 800 \text{ milliwatts}$$

The 156°C/W for the SOT-223 package assumes the use of the recommended footprint on a glass epoxy printed circuit board to achieve a power dissipation of 800 milliwatts. There are other alternatives to achieving higher power dissipation from the surface mount packages. One is to increase the area of the drain/collector pad. By increasing the area of the drain/collector pad, the power dissipation can be increased. Although the power dissipation can almost be doubled with this method, area is taken up on the printed circuit board which can defeat the purpose of using surface mount technology. For example, a graph of $R_{\theta JA}$ versus drain pad area is shown in Figures 65, 66 and 67.

Another alternative would be to use a ceramic substrate or an aluminum core board such as Thermal Clad™. Using a board material such as Thermal Clad, an aluminum core board, the power dissipation can be doubled using the same footprint.

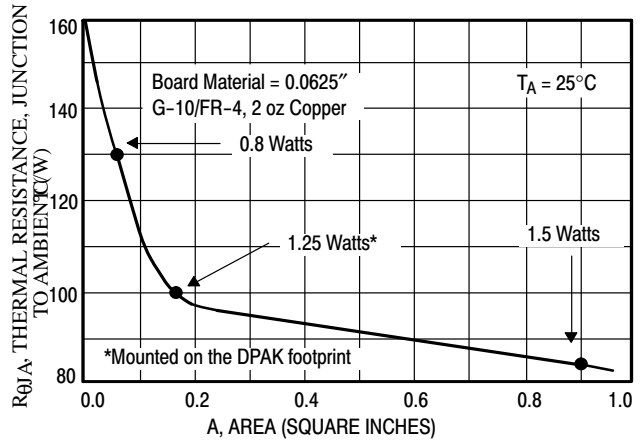


Figure 65. Thermal Resistance versus Drain Pad Area for the SOT-223 Package (Typical)

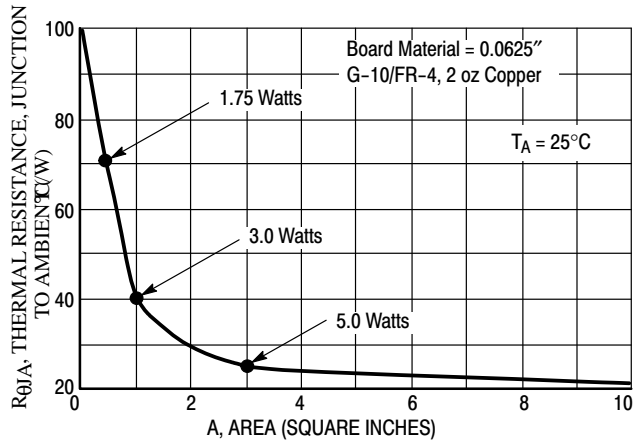


Figure 66. Thermal Resistance versus Drain Pad Area for the DPAK Package (Typical)

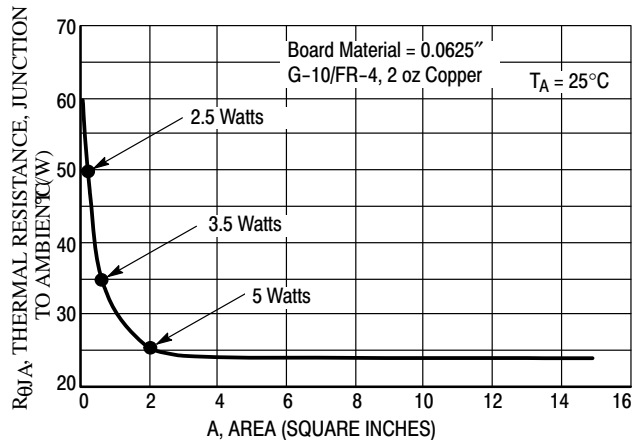


Figure 67. Thermal Resistance versus Drain Pad Area for the D²PAK Package (Typical)

SOLDER STENCIL GUIDELINES

Prior to placing surface mount components onto a printed circuit board, solder paste must be applied to the pads. Solder stencils are used to screen the optimum amount. These stencils are typically 0.008 inches thick and may be made of brass or stainless steel. For packages such as the SC-59, SC-70/SOT-323, SOD-123, SOT-23, SOT-143, SOT-223, SO-8, SO-14, SO-16, and SMB/SMC diode packages, the stencil opening should be the same as the pad size or a 1:1 registration. This is not the case with the DPAK and D²PAK packages. If a 1:1 opening is used to screen solder onto the drain pad, misalignment and/or “tombstoning” may occur due to an excess of solder. For these two packages, the opening in the stencil for the paste should be approximately 50% of the tab area. The opening for the leads is still a 1:1 registration. Figure 68 shows a typical stencil for the DPAK and D²PAK packages. The

pattern of the opening in the stencil for the drain pad is not critical as long as it allows approximately 50% of the pad to be covered with paste.

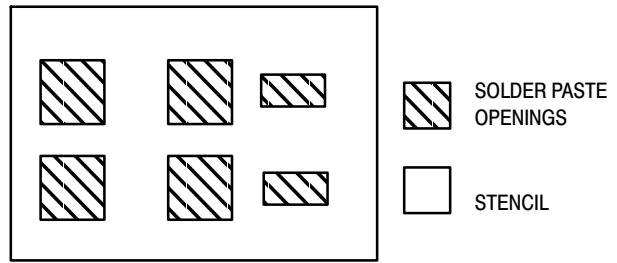


Figure 68. Typical Stencil for DPAK and D²PAK Packages

SOLDERING PRECAUTIONS

The melting temperature of solder is higher than the rated temperature of the device. When the entire device is heated to a high temperature, failure to complete soldering within a short time could result in device failure. Therefore, the following items should always be observed in order to minimize the thermal stress to which the devices are subjected.

- Always preheat the device.
- The delta temperature between the preheat and soldering should be 100°C or less.*
- When preheating and soldering, the temperature of the leads and the case must not exceed the maximum temperature ratings as shown on the data sheet. When using infrared heating with the reflow soldering method, the difference should be a maximum of 10°C.
- For wave soldering, the soldering temperature and time should not exceed 260°C for more than 10 seconds. For other reflow methods such as convection and IR ovens, refer to the reflow profiles on the following pages.

- When shifting from preheating to soldering, the maximum temperature gradient shall be 5°C or less.
- After soldering has been completed, the device should be allowed to cool naturally for at least three minutes. Gradual cooling should be used since the use of forced cooling will increase the temperature gradient and will result in latent failure due to mechanical stress.
- Mechanical stress or shock should not be applied during cooling.

* Soldering a device without preheating can cause excessive thermal shock and stress which can result in damage to the device.

* Due to shadowing and the inability to set the wave height to incorporate other surface mount components, the D²PAK is not recommended for wave soldering.

TYPICAL SOLDER HEATING PROFILE

For any given circuit board, there will be a group of control settings that will give the desired heat pattern. The operator must set temperatures for several heating zones and a figure for belt speed. Taken together, these control settings make up a heating “profile” for that particular circuit board. On machines controlled by a computer, the computer remembers these profiles from one operating session to the next. Figure 69 shows a typical heating profile for use when soldering a surface mount device to a printed circuit board. This profile will vary among soldering systems, but it is a good starting point. Factors that can affect the profile include the type of soldering system in use, density and types of components on the board, type of solder used, and the type of board or substrate material being used. This profile shows temperature versus time. The line on the graph shows the

actual temperature that might be experienced on the surface of a test board at or near a central solder joint. The two profiles are based on a high density and a low density board. The Vitronics SMD310 convection/infrared reflow soldering system was used to generate this profile. The type of solder used was 62/36/2 Tin Lead Silver with a melting point between 177–189°C. When this type of furnace is used for solder reflow work, the circuit boards and solder joints tend to heat first. The components on the board are then heated by conduction. The circuit board, because it has a large surface area, absorbs the thermal energy more efficiently, then distributes this energy to the components. Because of this effect, the main body of a component may be up to 30 degrees cooler than the adjacent solder joints.

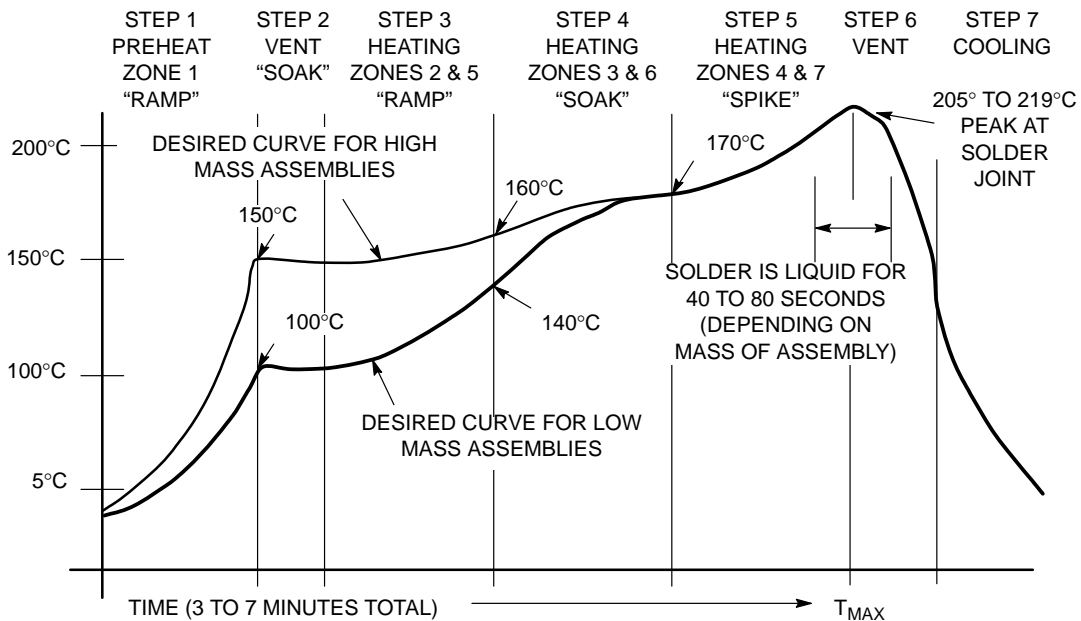


Figure 69. Typical Tin Lead (SnPb) Solder Heating Profile

TYPICAL SOLDER HEATING PROFILE (continued)

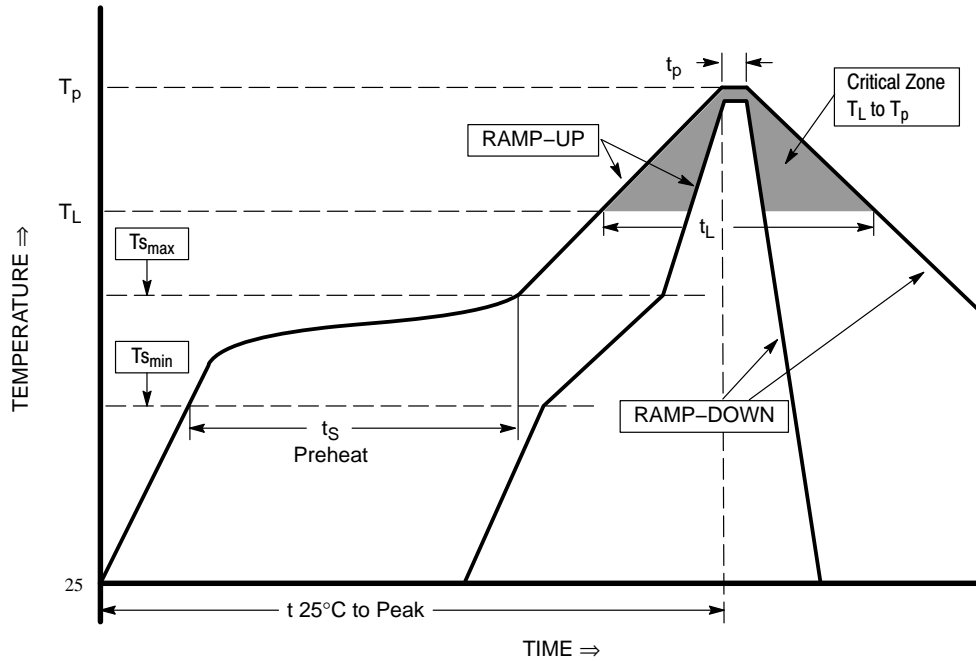


Figure 70. Typical Pb-Free Solder Heating Profile

Profile Feature	Pb-Free Assembly
Average Ramp-Up Rate ($T_{s_{max}}$ to T_p)	3°C/second max
Preheat Temperature Min ($T_{s_{min}}$) Temperature Max ($T_{s_{max}}$) Time ($t_{s_{min}}$ to $t_{s_{max}}$)	150°C 200°C 60–180 seconds
Time maintained above Temperature (T_T) Time (t_T)	217°C 60–150 seconds
Peak Classification Temperature (T_p)	260°C +5/-0
Time within 5°C of actual Peak Temperature (t_p)	20–40 seconds
Ramp-Down Rate	6°C/second max
Time 25°C to Peak Temperature	8 minutes max

AMBIENT MOUNTING DATA

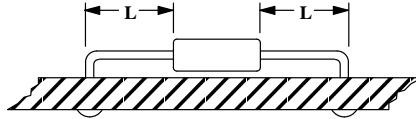
Data shown for thermal resistance junction-to-ambient ($R_{\theta JA}$) for the mountings shown is to be used as typical guideline values for preliminary engineering or in case the tie point temperature cannot be measured.

TYPICAL VALUES FOR $R_{\theta JA}$ IN STILL AIR

Mounting Method	$R_{\theta JA}$	Lead Length, L (IN)				Units
		1/8	1/4	1/2	3/4	
1	$R_{\theta JA}$	50	51	53	55	$^{\circ}\text{C/W}$
2		58	59	61	63	$^{\circ}\text{C/W}$
3		28				$^{\circ}\text{C/W}$

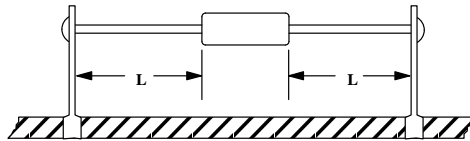
MOUNTING METHOD 1

P.C. Board Where Available Copper Surface area is small.



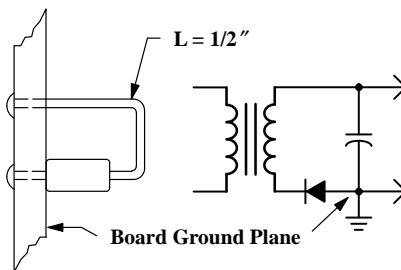
MOUNTING METHOD 2

Vector Push-In Terminals T-28



MOUNTING METHOD 3

P.C. Board with
1-1/2" x 1-1/2" Copper Surface



Humidity Indicator Card: Type HIC-0560

Objective

The objective of this information brief is to provide the customer with a general understanding of the humidity indicator cards (HIC) basic functions and a reaction plan based on the level of dryness as indicated on the card.

Introduction

The HIC is printed with moisture sensitive spots which will respond to variations of different levels of humidity with perceptible change in color typically from blue (dry) to pink (wet). The HIC is packed inside moisture barrier bags, which monitor the moisture inside the barrier bag. When the bag is opened, the HIC can be examined to determine the degree of dryness of the parts inside the bag.

Humidity Indicator Cards: HIC-0515 and HIC-0560

Excess humidity in the dry pack is noted by the HIC. It can occur due to misprocessing (e.g. missing or inadequate desiccant), mishandling (e.g. tears or rips in the moisture barrier bag) or improper storage.

The HIC should be read immediately upon removal from the moisture barrier bag. For best accuracy, the HIC should be read at $23\pm 5^{\circ}\text{C}$. The following conditions apply regardless of the storage time (whether or not the shelf life has exceeded).

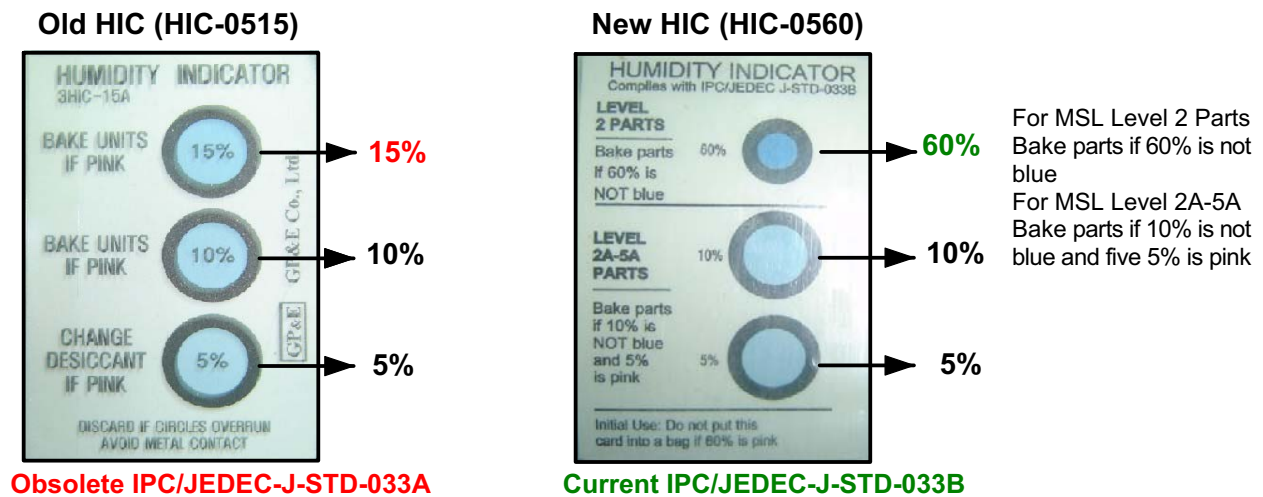


Figure 71. Humidity Indicator Card

Table 2: HIC Conditions and Corresponding Actions for HIC-0560

HIC Conditions	5%	10%	60%	Action	Remarks
Condition 1	Blue	Blue	Blue	No bake	Parts are dry
Condition 2	Pink	Blue	Blue	No bake	Only indicates that parts have 5% level of moisture
Condition 3	Pink	Pink	Blue	Bake required, refer to Table 2	Bake parts MSL levels 2a, 3, 4, 5, and 5a No need to bake MSL level 2
Condition 4	Pink	Pink	Pink	Bake required, refer to Table 2	All were parts were affected by moisture

Bake Duration for Exposed Parts

AMIS recommends that bake duration of exposed parts should comply with the existing provisions as mandated by Joint Industry Standard IPC/JEDEC-STD-033B entitled

“Handling, Packing and Use of Moisture/Reflow Sensitive Surface Mount Devices” Bake Duration for Exposed Parts as shown in Table 3.

Table 3: Reference Conditions for Drying Mounted or Unmounted SMD Packages (User bake: floor life beings counting at time = 0 after bake)

Package Body	Level	Bake @ 125°C		Bake @ 90°C ≤ 5% RH		Bake @ 40°C ≤ 5% RH	
		Exceeding Floor Life by > 72 h	Exceeding Floor Life by > 72 h	Exceeding Floor Life by > 72 h	Exceeding Floor Life by > 72 h	Exceeding Floor Life by > 72 h	Exceeding Floor Life by > 72 h
Thickness ≤ 1.4mm	2	5 hours	3 hours	17 hours	11 hours	8 days	5 days
	2a	7 hours	5 hours	23 hours	13 hours	9 days	7 days
	3	9 hours	7 hours	33 hours	23 hours	13 days	9 days
	4	11 hours	7 hours	37 hours	23 hours	15 days	9 days
	5	12 hours	7 hours	41 hours	24 hours	17 days	10 days
	5a	16 hours	10 hours	54 hours	24 hours	22 days	10 days
Thickness > 1.4mm ≤ 2.0mm	2	18 hours	15 hours	63 hours	2 days	25 days	20 days
	2a	21 hours	16 hours	3 days	2 days	29 days	22 days
	3	27 hours	17 hours	4 days	2 days	37 days	23 days
	4	34 hours	20 hours	5 days	3 days	47 days	28 days
	5	40 hours	25 hours	6 days	4 days	57 days	35 days
	5a	48 hours	40 hours	8 days	6 days	79 days	56 days
Thickness > 2.0mm ≤ 4.5mm	2	48 hours	48 hours	10 days	7 days	79 days	67 days
	2a	48 hours	48 hours	10 days	7 days	79 days	67 days
	3	48 hours	48 hours	10 days	8 days	79 days	67 days
	4	48 hours	48 hours	10 days	10 days	79 days	67 days
	5	48 hours	48 hours	10 days	10 days	79 days	67 days
	5a	48 hours	48 hours	10 days	10 days	79 days	67 days
BGA package > 17mm x 17mm or any stacked die package (Note 12)	2-6	96 hours	As above per package thickness and moisture level	Not applicable	As above per package thickness and moisture level	Not applicable	As above per package thickness and moisture level

NOTES:

11. Table 3 is based on worst-case molded lead frame SMD packages. Users may reduce the actual back time if technically justified (e.g. absorption/desorption data, etc.). In most cases it is applicable to other nonhermetic surface mount SMD packages.
12. For BGA packages > 17mm x >17 mm that do not have internal planes that block the moisture diffusion path in the substrate they may use bake times based on the thickness/moisture level portion of the table.

Sales and Design Assistance from ON Semiconductor

ON Semiconductor Technical Support
www.onsemi.com/support

ON SEMICONDUCTOR INTERNATIONAL SALES OFFICES		
GREATER CHINA	Beijing	86-10-8577-8200
	Hong Kong	852-2689-0088
	Shenzhen	86-755-8209-1128
	Shanghai	86-21-5131-7168
	Taipei, Taiwan	886-2-2377-9911
FRANCE	Paris	33 (0)1 39-26-41-00
GERMANY	Munich	49 (0) 89-93-0808-0
INDIA	Bangalore	91-98-808-86706
ISRAEL	Raanana	972 (0) 9-9609-111
ITALY	Milano	39 02 9239311
JAPAN	Tokyo	81-3-6880-1777
KOREA	Seoul	82-31-786-3700
MALAYSIA	Penang	60-4-6463877
SINGAPORE	Singapore	65-6484-8603
SLOVAKIA	Piestany	421 33 790 2450
UNITED KINGDOM	Maidenhead	44 (0) 1628 244326

For a comprehensive listing of
**ON Semiconductor Sales Offices, Distributors,
 and Rep Firms, please visit:**

Americas & EMEA: www.onsemi.com/sales
China: www.onsemi.cn/sales
Japan: www.onsemi.jp/sales



AMERICAS REP FIRMS

Alabama	Huntsville	e-Components	(256) 533-2444
Brazil	Countrywide	Ammon & Rizos	(+55) 11-4688-1960
California	Bay Area	Electec	(408) 496-0706
Canada	Eastern Canada	Astec	(905) 607-1444
Connecticut	Statewide	Paragon Electronic Systems	(603) 645-7630
Florida	Statewide	e-Components	(888) 468-2444
Georgia	Atlanta	e-Components	(888) 468-2444
Illinois	Statewide	Matrix - Design Technology	(952) 400-1070
Indiana	Fishers	Bear VAI	(317) 570-0707
Iowa	Statewide	Matrix - Design Technology	(319) 362-6824
Maine	Statewide	Paragon Electronic Systems	(603) 645-7630
Maryland	Columbia	Mechtronics Sales	(410) 309-9600
Massachusetts	Statewide	Paragon Electronic Systems	(603) 645-7630
Mexico	Countrywide	Ammon & Rizos	(+55) 11-4688-1960
Michigan	St. Joseph	Bear VAI	(440) 526-1991
Minnesota	Eden Prairie	Matrix - Design Technology	(952) 400-1070
Missouri	Belton	Matrix - Design Technology	(816) 589-2308
Nebraska	Statewide	Matrix - Design Technology	(816) 589-2308
New Hampshire	Statewide	Paragon Electronic Systems	(603) 645-7630
New Jersey	Statewide	S.J. Metro	(516) 942-3232
New York	Binghamton	TriTech - Full Line Rep	(607) 722-3580
	Jericho	S.J. Metro	(516) 942-3232
	Rochester	TriTech - Full Line Rep	(585) 385-6500
North Carolina	Raleigh	e-Components	(888) 468-2444
North Dakota	Statewide	Matrix - Design Technology	(952) 400-1070
Ohio	Brecksville	Bear VAI Technology	(440) 526-1991
Puerto Rico	Countrywide	e-Components	(888) 468-2444
Rhode Island	Statewide	Paragon Electronic Systems	(603) 645-7630
South Dakota	Statewide	Matrix - Design Technology	(952) 400-1070
Vermont	Statewide	Paragon Electronic Systems	(603) 645-7630
Wisconsin	Statewide	Matrix - Design Technology	(952) 400-1070

ON Semiconductor Distribution Partners

Allied Electronics	www.alliedelec.com	(800) 433-5700
ALTIMA Company, Macnica, Inc.	www.alt.macnica.co.jp/about/english.html	(81) 45 476 2155
Arrow Electronics	www.arrow.com	(800) 777-2776
Avnet	www.em.avnet.com	(800) 332-8638
Daiwa Distribution Ltd.	www.daiwahk.com	(852) 2341 3351
Digi-Key	www.digikey.com	(800) 344-4539
EBV Elektronik	www.ebv.com/en/locations.html	(49) 8121 774-0
Future & FAI Electronics	www.futureelectronics.com/contact	1-800-FUTURE1 (388-8731)
Mouser Electronics	www.mouser.com	(800) 346-6873
Newark/Farnell	www.farnell.com/onsemi	(800) 4-NEWARK
OS Electronics Co., Ltd.	www.oselec.com	Japanese: (81) 3 3255 5985 Other Languages: (81) 3 3255 6066
Promate Electronic Co.	www.promate.com.tw	(886) 2 2659 0303
Ryoden Corporation	www.ryoden.co.jp/en	(81) 3 5396 6310
Ryosan Company, Limited	www.ryosan.co.jp/eng	(81) 3 3862 2635
RS Components	www.rs-components.com	(44) 153 644 4414
Segyung Britestone Co.	www.britestone.com	(82) 2 3218 1511
Serial Microelectronics, HK	www.serialsys.com.hk	(852) 2790 8220
World Peace Industries Co.	www.wpi-group.com	(852) 2365 4860
WT Microelectronics Co.	www.wtmec.com	(852) 2950 0820
Yosun Electronics	www.yosun.com.tw	(886) 2 2659 8168

MatrixCam is a trademark of Semiconductor Components Industries, LLC (SCILLC) or its subsidiaries in the United States and/or other countries. ARM and Cortex are registered trademarks of ARM Limited (or its subsidiaries) in the EU and/or elsewhere. Bluetooth is registered trademark of Bluetooth SIG. EnOcean and the EnOcean logo are registered trademarks of EnOcean GmbH. G3-PLC and the G3-PLC logo are trademarks of the G3-PLC Alliance. HART is a registered trademark of the HART Communication Foundation. iOS is a registered trademark of Apple Inc. KNX and the KNX logos are registered trademarks of KNX and its suppliers or licensors. Micro8 is a trademark of International Rectifier. OMS is a registered trademark of OMS Group, Germany. SIGFOX and the SIGFOX logo are trademarks of SIGFOX. Wi-Fi is a registered trademark of the Wi-Fi Alliance. ZigBee is a registered trademark of ZigBee Alliance. All other brand names and product names appearing in this document are trademarks of their respective holders.

ON Semiconductor and the ON Semiconductor logo are trademarks of Semiconductor Components Industries, LLC dba ON Semiconductor or its subsidiaries in the United States and/or other countries. ON Semiconductor owns the rights to a number of patents, trademarks, copyrights, trade secrets, and other intellectual property. A listing of ON Semiconductor's product/patent coverage may be accessed at www.onsemi.com/site/pdf/Patent-Marking.pdf. ON Semiconductor reserves the right to make changes without further notice to any products herein. ON Semiconductor makes no warranty, representation or guarantee regarding the suitability of its products for any particular purpose, nor does ON Semiconductor assume any liability arising out of the application or use of any product or circuit, and specifically disclaims any and all liability, including without limitation special, consequential or incidental damages. Buyer is responsible for its products and applications using ON Semiconductor products, including compliance with all laws, regulations and safety requirements or standards, regardless of any support or applications information provided by ON Semiconductor. "Typical" parameters which may be provided in ON Semiconductor data sheets and/or specifications can and do vary in different applications and actual performance may vary over time. All operating parameters, including "Typicals" must be validated for each customer application by customer's technical experts. ON Semiconductor does not convey any license under its patent rights nor the rights of others. ON Semiconductor products are not designed, intended, or authorized for use as a critical component in life support systems or any FDA Class 3 medical devices or medical devices with a same or similar classification in a foreign jurisdiction or any devices intended for implantation in the human body. Should Buyer purchase or use ON Semiconductor products for any such unintended or unauthorized application, Buyer shall indemnify and hold ON Semiconductor and its officers, employees, subsidiaries, affiliates, and distributors harmless against all claims, costs, damages, and expenses, and reasonable attorney fees arising out of, directly or indirectly, any claim of personal injury or death associated with such unintended or unauthorized use, even if such claim alleges that ON Semiconductor was negligent regarding the design or manufacture of the part. ON Semiconductor is an Equal Opportunity/Affirmative Action Employer. This literature is subject to all applicable copyright laws and is not for resale in any manner.

PUBLICATION ORDERING INFORMATION

LITERATURE FULFILLMENT:

Literature Distribution Center for ON Semiconductor
 19521 E. 32nd Pkwy, Aurora, Colorado 80011 USA
Phone: 303-675-2175 or 800-344-3860 Toll Free USA/Canada
Fax: 303-675-2176 or 800-344-3867 Toll Free USA/Canada
Email: orderlit@onsemi.com

N. American Technical Support: 800-282-9855 Toll Free
 USA/Canada.

Europe, Middle East and Africa Technical Support:
 Phone: 421 33 790 2910

ON Semiconductor Website: www.onsemi.com

Order Literature: <http://www.onsemi.com/orderlit>

For additional information, please contact your local
 Sales Representative