

Product Summary

BV_{DSS}	R_{DS(ON)}	I_D T_A = +25°C
30V	0.025Ω@V _{GS} = 4.5V	8.9A

Description

This new generation of Trench MOSFETs from Diodes Incorporated utilizes a unique structure that combines the benefits of low on-resistance with fast switching speed. This makes them ideal for high efficiency, low voltage, power management applications.

Applications

- DC-DC Converters
- Power Management Functions
- Disconnect Switches
- Motor Control

Features

- Low On-Resistance
- Fast Switching Speed
- Low Threshold
- Low Gate Drive
- Low Profile SO-8 Package
- **Totally Lead-Free & Fully RoHS Compliant (Notes 1 & 2)**
- **Halogen and Antimony Free. "Green" Device (Note 3)**

Mechanical Data

- Case: SO-8
- Case Material: Molded Plastic, "Green" Molding Compound, UL Flammability Classification Rating 94V-0
- Moisture Sensitivity: Level 1 per J-STD-020
- Terminals: Matte Tin Finish Annealed over Copper Leadframe. Solderable per MIL-STD-202, Method 208 Ⓒ3
- Weight: 0.076 grams (Approximate)

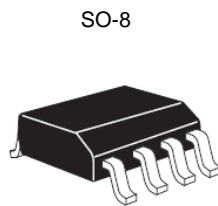

Top View

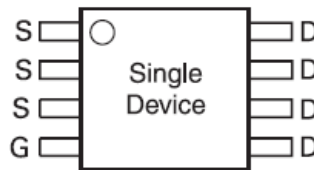

Top View
Pin Out Configuration

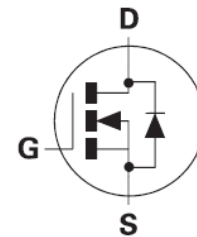

Equivalent Circuit

Ordering Information (Note 4)

Part Number	Case	Reel Size	Tape Width	Quantity Per Reel
ZXMN3B04N8TA	SO-8	7"	12mm	500 Units
ZXMN3B04N8TC	SO-8	13"	12mm	2500 Units

- Notes:
1. No purposely added lead. Fully EU Directive 2002/95/EC (RoHS) & 2011/65/EU (RoHS 2) compliant.
 2. See http://www.diodes.com/quality/lead_free.html for more information about Diodes Incorporated's definitions of Halogen- and Antimony-free, "Green" and Lead-free.
 3. Halogen- and Antimony-free "Green" products are defined as those which contain <900ppm bromine, <900ppm chlorine (<1500ppm total Br + Cl) and <1000ppm antimony compounds.
 4. For packaging details, go to our website at <http://www.diodes.com/products/packages.html>.

Marking Information

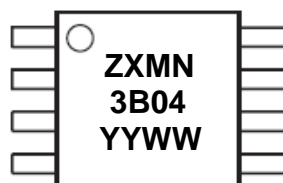

ZXMN3B04 = Product Type Marking Code
 YYWW = Date Code Marking
 YY = Last Two Digits of Year (ex: 17 = 2017)
 WW = Week Code (01 to 53)

Maximum Ratings

Characteristic	Symbol	Value	Unit
Drain-Source Voltage	V_{DS}	30	V
Gate-Source Voltage	V_{GS}	± 12	V
Continuous Drain Current @ $V_{GS} = 4.5V$	I_D	$T_A = +25^\circ C$ (Note 6)	8.9
		$T_A = +70^\circ C$ (Note 6)	7.3
		$T_A = +25^\circ C$ (Note 5)	7.2
Pulsed Drain Current (Note 7)	I_{DM}	45	A
Continuous Source Current (Body Diode) (Note 6)	I_S	4.5	A
Pulsed Source Current (Body Diode) (Note 7)	I_{SM}	45	A
Power Dissipation at $T_A = +25^\circ C$ (Note 5)	P_D	2	W
Linear Derating Factor		16	mW/ $^\circ C$
Power Dissipation at $T_A = +25^\circ C$ (Note 6)	P_D	3	W
Linear Derating Factor		24	mW/ $^\circ C$
Operating and Storage Temperature Range	T_J, T_{STG}	-55 to +150	$^\circ C$

Thermal Characteristics

Characteristic	Symbol	Value	Unit
Thermal Resistance, Junction to Ambient (Note 5)	$R_{\theta JA}$	62.5	$^\circ C/W$
Thermal Resistance, Junction to Ambient (Note 6)	$R_{\theta JA}$	41.4	

- Notes:
- For a device surface mounted on 50mm x 50mm FR-4 PCB with high coverage of single sided 2oz copper, in still air conditions.
 - For a device surface mounted on FR-4 PCB measured at $t \leq 10$ sec.
 - Repetitive rating - 25mm x 25mm FR-4 PCB, $D=0.02$, pulse width 300 μs - pulse width limited by maximum junction temperature.

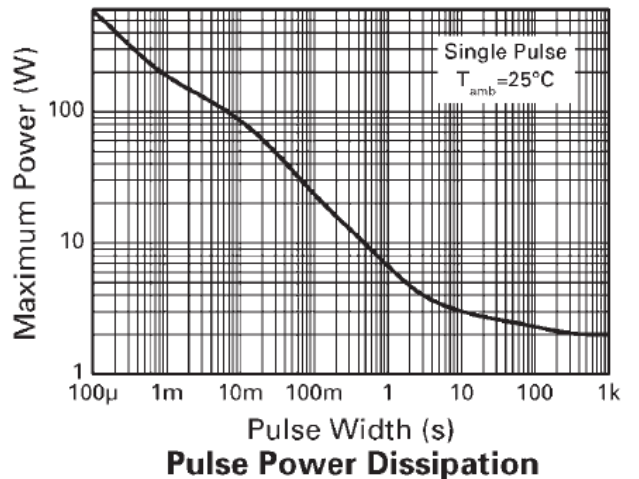
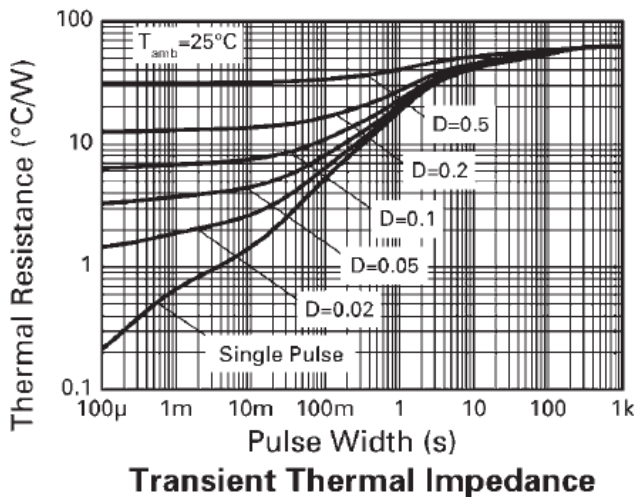
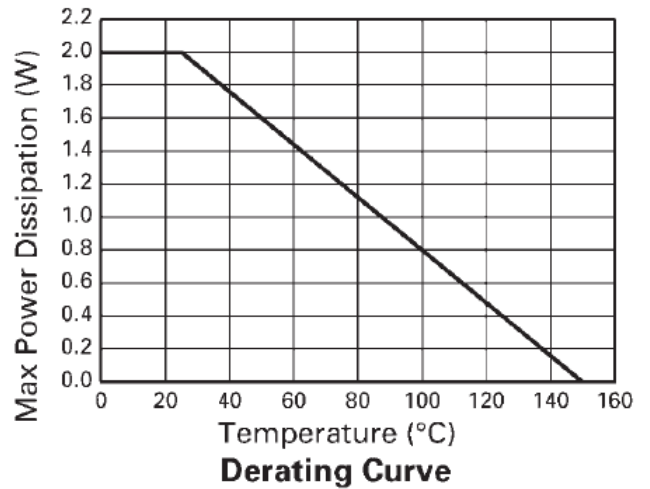
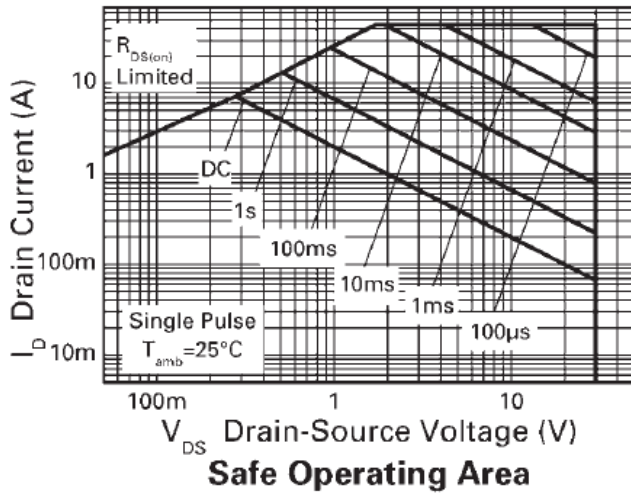

Electrical Characteristics (@T_A = +25°C, unless otherwise specified.)

Characteristic	Symbol	Min	Typ	Max	Unit	Test Condition
STATIC						
Drain-Source Breakdown Voltage	BV _{DSS}	30	—	—	V	V _{GS} = 0V, I _D = 250μA
Zero Gate Voltage Drain Current	I _{DSS}	—	—	0.5	μA	V _{DS} = 30V, V _{GS} = 0V
Gate-Body Leakage	I _{GSS}	—	—	100	nA	V _{GS} = ±12V, V _{DS} = 0V
Gate-Source Threshold Voltage	V _{GS(TH)}	0.7	—	—	V	V _{DS} = V _{GS} , I _D = 250μA
Static Drain-Source On-Resistance (Note 8)	R _{DS(ON)}	—	0.021	0.025	Ω	V _{GS} = 4.5V, I _D = 7.2A
		—	0.028	0.040		V _{GS} = 2.5V, I _D = 5.7A
Forward Transconductance (Notes 8 and 10)	g _{fs}	—	24	—	S	V _{DS} = 15V, I _D = 7.2A
DYNAMIC (Note 10)						
Input Capacitance	C _{iss}	—	2480	—	pF	V _{DS} = 15V, f = 1.0MHz, V _{GS} = 0V
Output Capacitance	C _{oss}	—	318	—		
Reverse Transfer Capacitance	C _{rss}	—	184	—		
SWITCHING (Notes 9 and 10)						
Turn-On Delay Time	t _{D(ON)}	—	9	—	ns	V _{DD} = 15V, R _G = 6.0Ω, I _D = 1A, V _{GS} = 4.5V
Rise Time	t _R	—	11.5	—		
Turn-Off Delay Time	t _{D(OFF)}	—	40	—		
Fall Time	t _F	—	16.6	—	nC	V _{DS} = 15V, V _{GS} = 4.5V, I _D = 7.2A
Total Gate Charge	Q _g	—	23.1	—		
Gate-Source Charge	Q _{gs}	—	4.9	—		
Gate-Drain Charge	Q _{gd}	—	6.2	—		
SOURCE-DRAIN DIODE						
Diode Forward Voltage (Note 8)	V _{SD}	—	0.85	0.95	V	T _J = +25°C, I _S = 8A, V _{GS} = 0V
Reverse Recovery Time (Note 10)	t _{RR}	—	17.9	—	ns	di/dt = 100A/μs, I _F = 3.2A,
Reverse Recovery Charge (Note 10)	Q _{RR}	—	10	—	nC	T _J = +25°C

- Notes:
8. Measured under pulsed conditions. Pulse width ≤ 300μs; duty cycle ≤ 2%.
 9. Switching characteristics are independent of operating junction temperature.
 10. For design aid only, not subject to production testing.

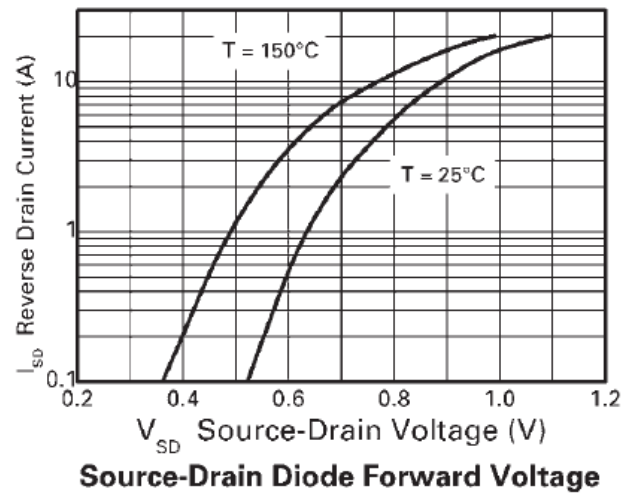
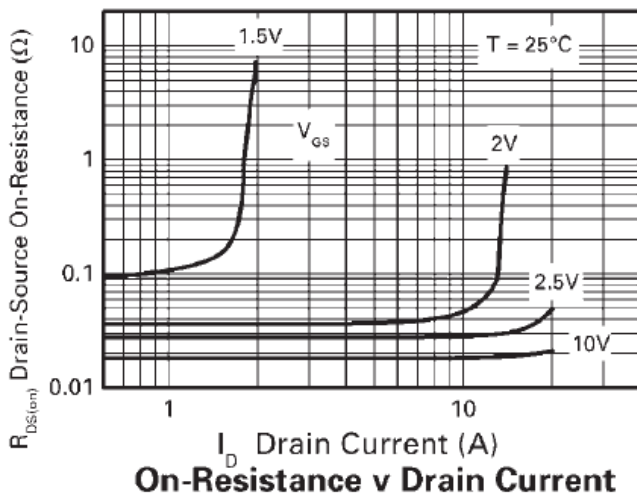
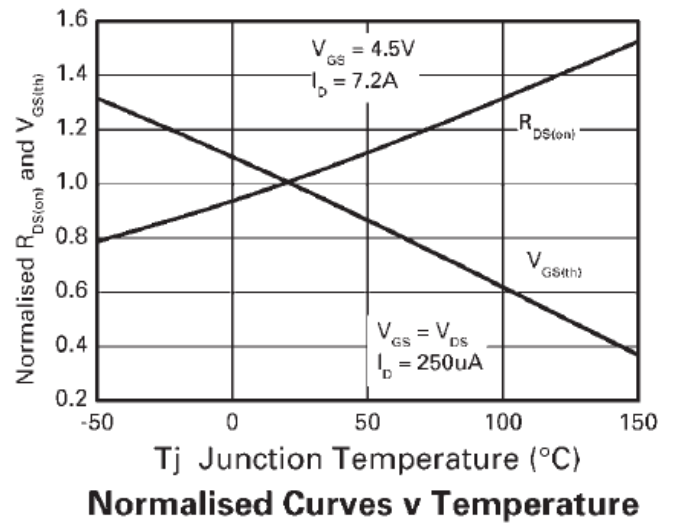
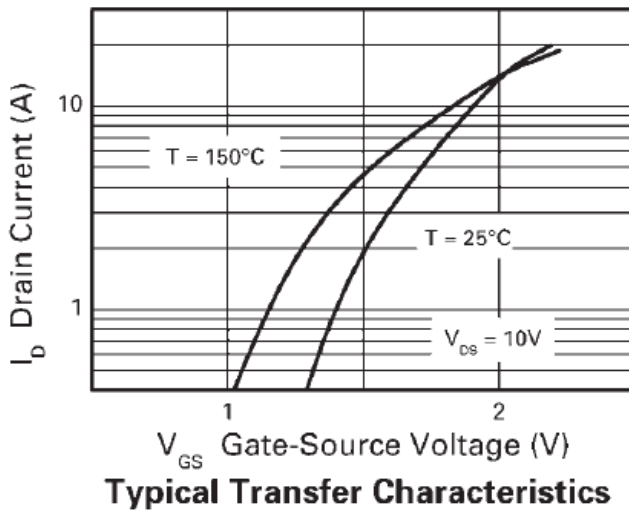
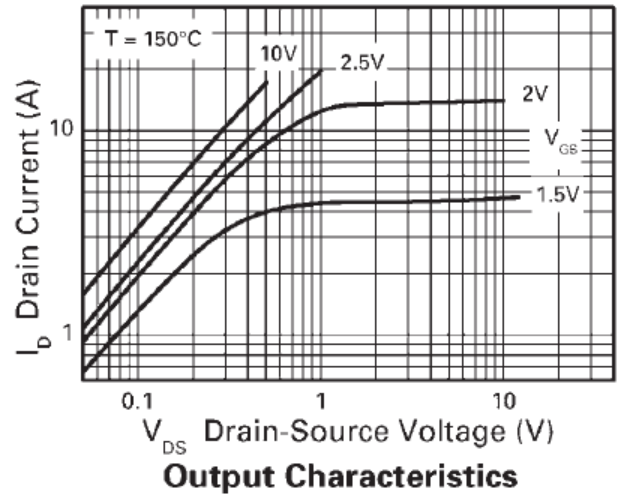
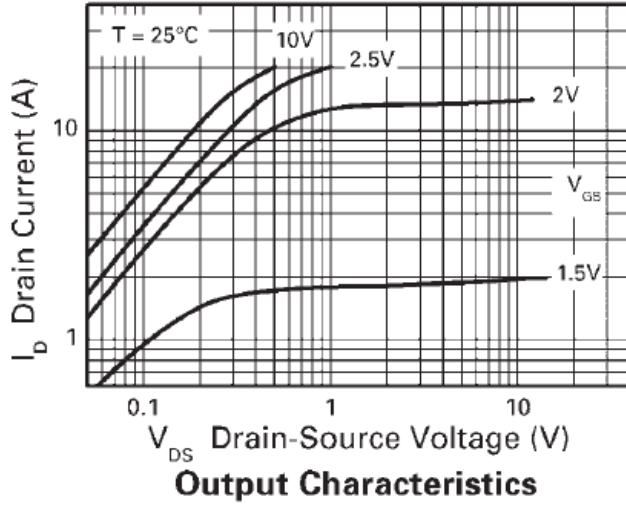

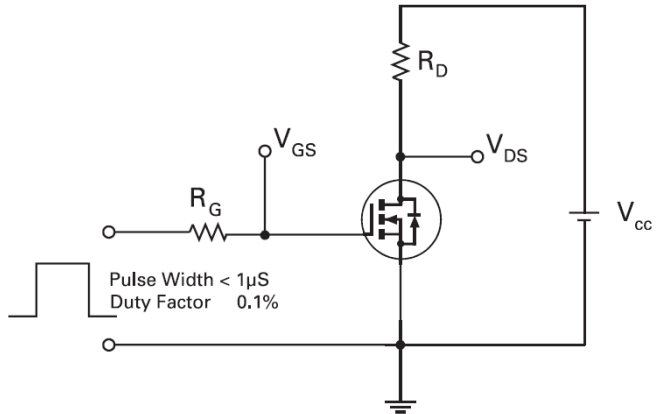
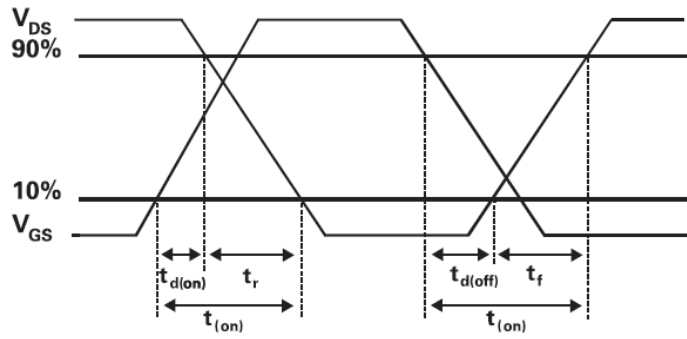
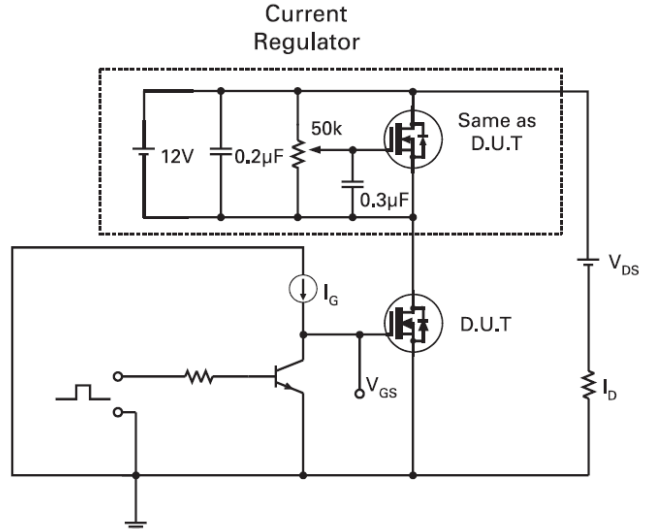
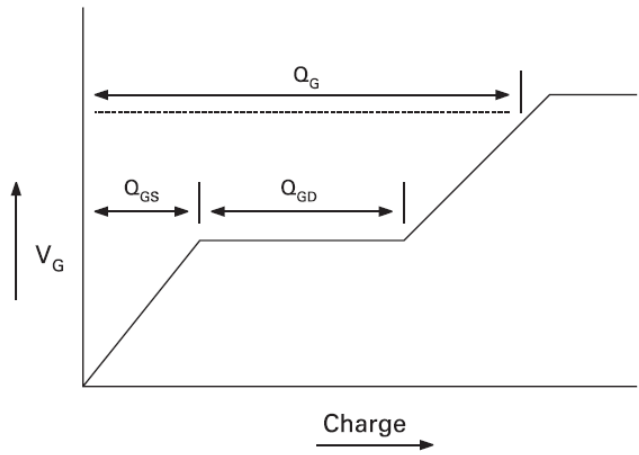
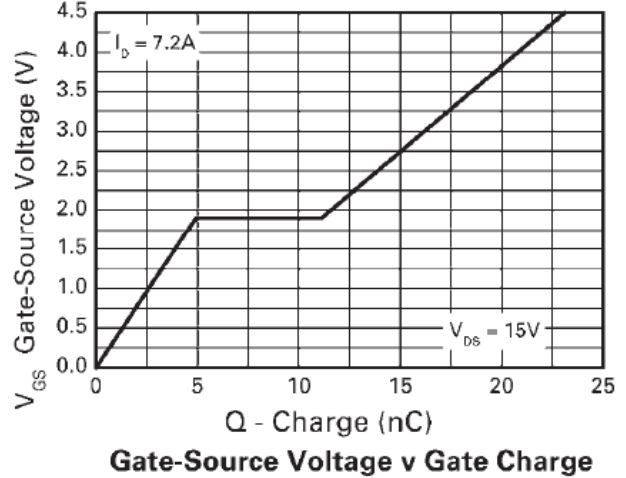
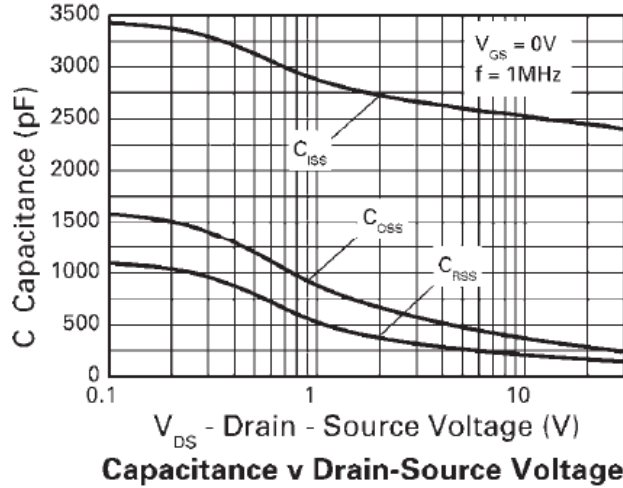

Package Outline Dimensions

Please see <http://www.diodes.com/package-outlines.html> for the latest version.

SO-8

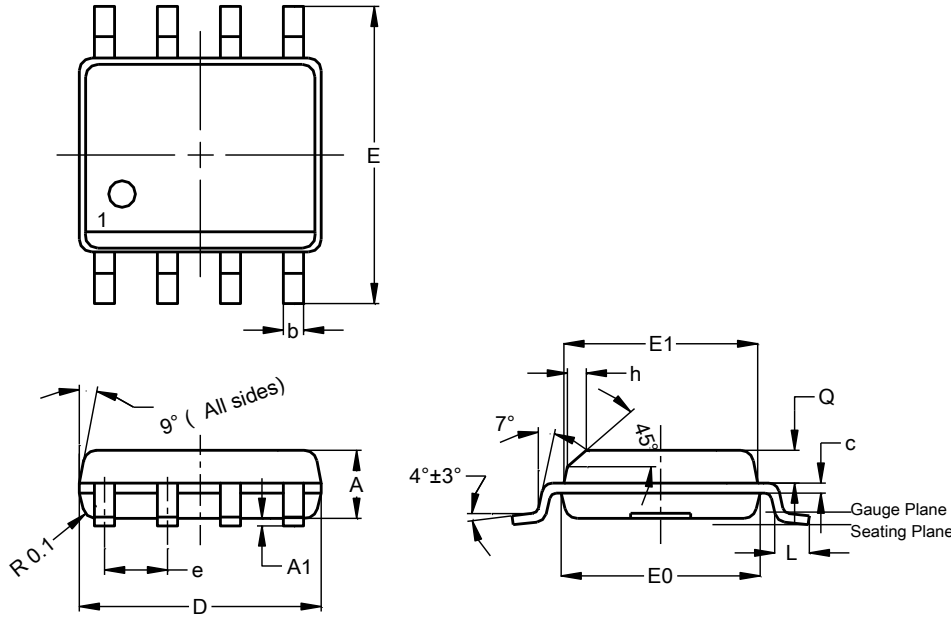

SO-8			
Dim	Min	Max	Typ
A	1.40	1.50	1.45
A1	0.10	0.20	0.15
b	0.30	0.50	0.40
c	0.15	0.25	0.20
D	4.85	4.95	4.90
E	5.90	6.10	6.00
E1	3.80	3.90	3.85
E0	3.85	3.95	3.90
e	--	--	1.27
h	--	--	0.35
L	0.62	0.82	0.72
Q	0.60	0.70	0.65
All Dimensions in mm			

Suggested Pad Layout

Please see <http://www.diodes.com/package-outlines.html> for the latest version.

SO-8

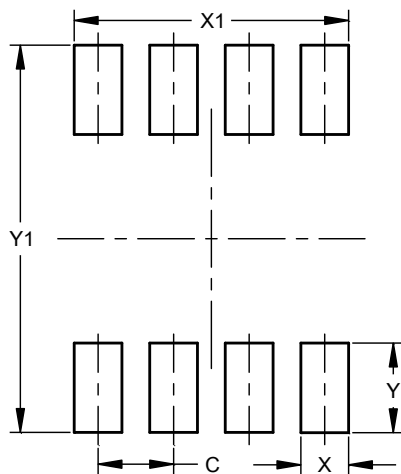

Dimensions	Value (in mm)
C	1.27
X	0.802
X1	4.612
Y	1.505
Y1	6.50

IMPORTANT NOTICE

DIODES INCORPORATED MAKES NO WARRANTY OF ANY KIND, EXPRESS OR IMPLIED, WITH REGARDS TO THIS DOCUMENT, INCLUDING, BUT NOT LIMITED TO, THE IMPLIED WARRANTIES OF MERCHANTABILITY AND FITNESS FOR A PARTICULAR PURPOSE (AND THEIR EQUIVALENTS UNDER THE LAWS OF ANY JURISDICTION).

Diodes Incorporated and its subsidiaries reserve the right to make modifications, enhancements, improvements, corrections or other changes without further notice to this document and any product described herein. Diodes Incorporated does not assume any liability arising out of the application or use of this document or any product described herein; neither does Diodes Incorporated convey any license under its patent or trademark rights, nor the rights of others. Any Customer or user of this document or products described herein in such applications shall assume all risks of such use and will agree to hold Diodes Incorporated and all the companies whose products are represented on Diodes Incorporated website, harmless against all damages.

Diodes Incorporated does not warrant or accept any liability whatsoever in respect of any products purchased through unauthorized sales channel. Should Customers purchase or use Diodes Incorporated products for any unintended or unauthorized application, Customers shall indemnify and hold Diodes Incorporated and its representatives harmless against all claims, damages, expenses, and attorney fees arising out of, directly or indirectly, any claim of personal injury or death associated with such unintended or unauthorized application.

Products described herein may be covered by one or more United States, international or foreign patents pending. Product names and markings noted herein may also be covered by one or more United States, international or foreign trademarks.

This document is written in English but may be translated into multiple languages for reference. Only the English version of this document is the final and determinative format released by Diodes Incorporated.

LIFE SUPPORT

Diodes Incorporated products are specifically not authorized for use as critical components in life support devices or systems without the express written approval of the Chief Executive Officer of Diodes Incorporated. As used herein:

A. Life support devices or systems are devices or systems which:

1. are intended to implant into the body, or
2. support or sustain life and whose failure to perform when properly used in accordance with instructions for use provided in the labeling can be reasonably expected to result in significant injury to the user.

B. A critical component is any component in a life support device or system whose failure to perform can be reasonably expected to cause the failure of the life support device or to affect its safety or effectiveness.

Customers represent that they have all necessary expertise in the safety and regulatory ramifications of their life support devices or systems, and acknowledge and agree that they are solely responsible for all legal, regulatory and safety-related requirements concerning their products and any use of Diodes Incorporated products in such safety-critical, life support devices or systems, notwithstanding any devices- or systems-related information or support that may be provided by Diodes Incorporated. Further, Customers must fully indemnify Diodes Incorporated and its representatives against any damages arising out of the use of Diodes Incorporated products in such safety-critical, life support devices or systems.

Copyright © 2017, Diodes Incorporated

www.diodes.com