

Application & Main Feature

Commercial Grade (High Temperature Application)

Series

C2012 [EIA CC0805]

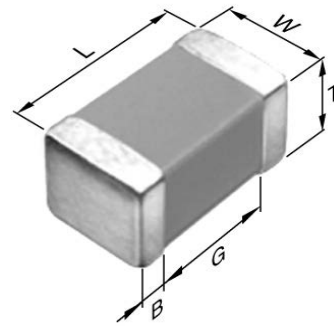

Dimensions

L	2.00mm +/-0.2mm
W	1.25mm +/-0.2mm
T	1.25 +/-0.2mm
B	0.2mm Min.
G	0.5mm Min.

Temperature Characteristic

NP0 (-55 to 150 degC 0+/-30ppm/degC)

Rated Voltage

2E (250Vdc)

Capacitance

5.6nF

Capacitance Tolerance

J (+/-5%)

Q Factor

1000 Min.

Insulation Resistance

10Gohm Min

AEC-Q200

Not Applicable

