

Schnelle PIN-Fotodiode
High Speed PIN-Photodiode
Lead (Pb) Free Product - RoHS Compliant

SFH 2302



Wesentliche Merkmale

- Speziell geeignet für Anwendungen von 400nm bis 1050nm
- Sehr kurze Schaltzeit im spezifizierten Wellenlängenbereich
- Sehr kurze Schaltzeit bei geringer Sperrspannung (<5V)
- Extrem kurze Abklingzeit („slow tail“)
- 3 mm-Plastikbauform im LED-Gehäuse

Anwendungen

- Optische Laufwerke (CD, DVD)
- Lichtschranken für Gleich- und Wechselbetrieb
- Industrieelektronik
- „Messen/Steuern/Regeln“
- LWL
- Abstandsmesser

Features

- Especially suitable for applications from 400nm to 1050nm
- Fast switching time within the specified wavelength
- Fast switching time at low reverse voltage (<5V)
- Ultra short decay time („slow tail“)
- 3 mm LED plastic package

Applications

- Optical Disc Drives (CD, DVD)
- Photointerrupters
- Industrial electronics
- For control and drive circuits
- Fibre optic transmission systems
- Range Finders

Typ Type	Bestellnummer Ordering Code
SFH 2302	Q65110A6343

Grenzwerte
Maximum Ratings

Bezeichnung Parameter	Symbol Symbol	Wert Value	Einheit Unit
Betriebs- und Lagertemperatur Operating and storage temperature range	$T_{op}; T_{stg}$	- 40 ... + 100	°C
Sperrspannung Reverse voltage	V_R	15	V
Sperrspannung, $t < 120$ s Reverse voltage	V_R	20	V
Verlustleistung Total power dissipation	P_{tot}	150	mW
Elektrostatische Entladung Electrostatic Discharge Human Body Model according to EOS/ESD-5.1-1993	ESD	2	kV

Kennwerte ($T_A = 25$ °C)

Characteristics

Bezeichnung Parameter	Symbol Symbol	Wert Value			Einheit Unit
		min	typ	max	
Spektrale Fotoempfindlichkeit des Chips Spectral sensitivity of the chip $\lambda = 650\text{nm}$ $\lambda = 780\text{nm}$	$\lambda_{S\ max}$		0.45 0.5		A/W
Fotostrom, $V_R = 5$ V, $E_e = 0.5$ mW/cm ² Photocurrent $\lambda = 650\text{nm}$ $\lambda = 780\text{nm}$	I_P		10 11		µA
Wellenlänge der max. Fotoempfindlichkeit Wavelength of max. sensitivity	$\lambda_{S\ max}$		820		nm
Spektraler Bereich der Fotoempfindlichkeit Spectral range of sensitivity $S = 10\%$ of S_{max}	λ		400..1050		nm
Abmessung der bestrahlungsempfindlichen Fläche Dimensions of radiant sensitive area	$L \times B$ $L \times W$		0.6 × 0.6		mm × mm
Abstand Chipoberfläche zu Gehäuseoberfläche Distance chip front to case surface	H		2.4 ... 2.8		mm

Kennwerte ($T_A = 25\text{ °C}$)

Characteristics (cont'd)

Bezeichnung Parameter	Symbol Symbol	Wert Value			Einheit Unit
		min	typ	max	
Halbwinkel Half angle	φ		± 17		Grad deg.
Dunkelstrom, $V_R = 5\text{ V}$ Dark current	I_R		0.05	5	nA
Anstiegs- und Abfallzeit des Fotostromes Rise and fall time of the photocurrent, 10% - 90% $V_R = 5\text{ V}$, $R_L = 50\ \Omega$; $\lambda = 650\text{ nm}$; $I_p = 1\text{ mA}$ $V_R = 5\text{ V}$, $R_L = 50\ \Omega$; $\lambda = 780\text{ nm}$; $I_p = 1\text{ mA}$	t_r, t_f t_r, t_f		1.8 2.0		ns ns
Kapazität, $f = 1\text{ MHz}$, $E = 0$, $V_R = 0\text{ V}$ Capacitance	C_0		3	5	pF
Temperaturkoeffizient von I_p Temperature coefficient of I_p $\lambda = 650\text{ nm}$ $\lambda = 780\text{ nm}$	TC_1		-0.03 -0.01		%/K %/K
Rauschäquivalente Strahlungsleistung ¹⁾ Noise equivalent power, $V_R = 5\text{ V}$, $\lambda = 650\text{ nm}$			8.9×10^{-15}		$\frac{W}{\sqrt{Hz}}$

$$^1) \text{ NEP} = 17,9 \times 10^{-15} \times \frac{\sqrt{I_R}}{S_\lambda}$$

Relative Spectral Sensitivity

$S_{rel} = f(\lambda)$

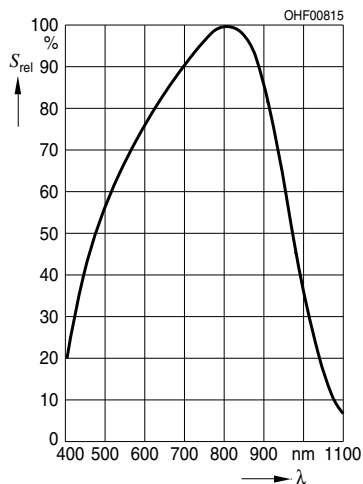

Total Power Dissipation

$P_{tot} = f(T_A)$

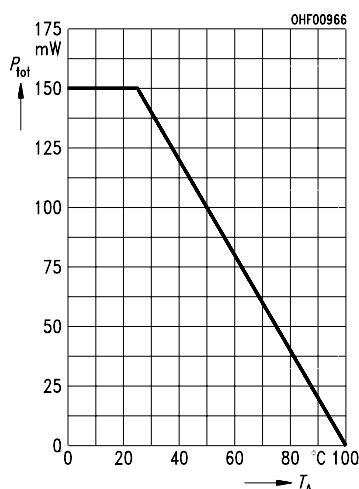

Capacitance

$C_0 = f(V_R), E = 0$

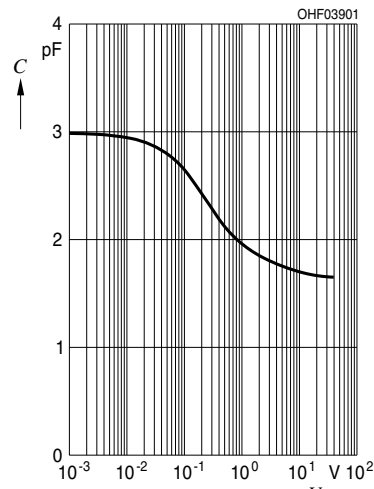

Dark Current

$I_R = f(V_R), E = 0$

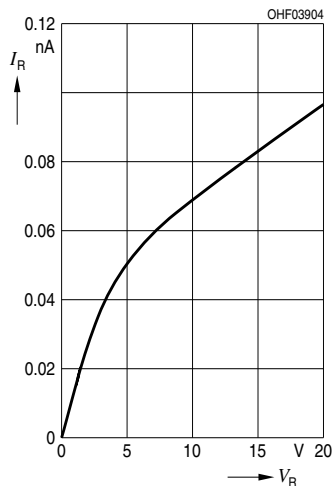

Dark Current

$I_R = f(T_A), E = 0, V_R = 5 V$

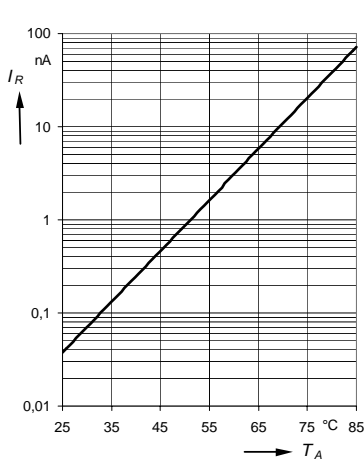

Switching Time

$t_r, t_f = f(V_R)$

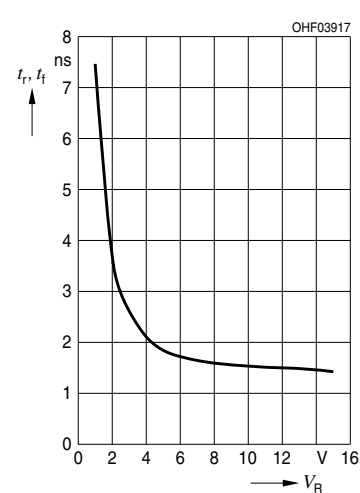

Directional Characteristics

$S_{rel} = f(\varphi)$

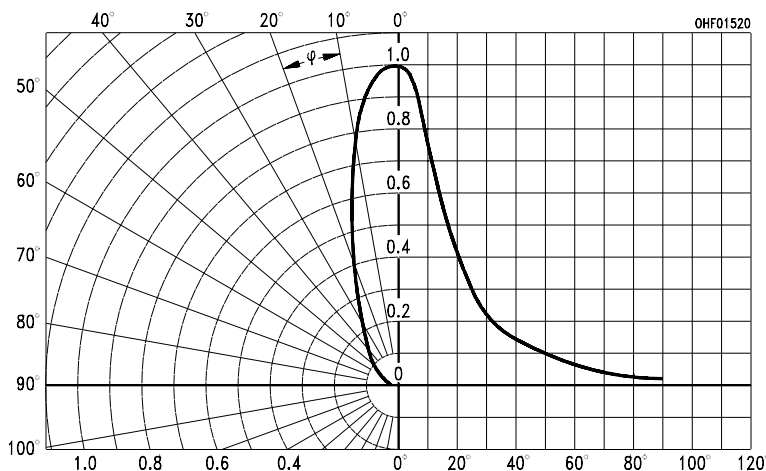

**Maßzeichnung
Package Outlines**

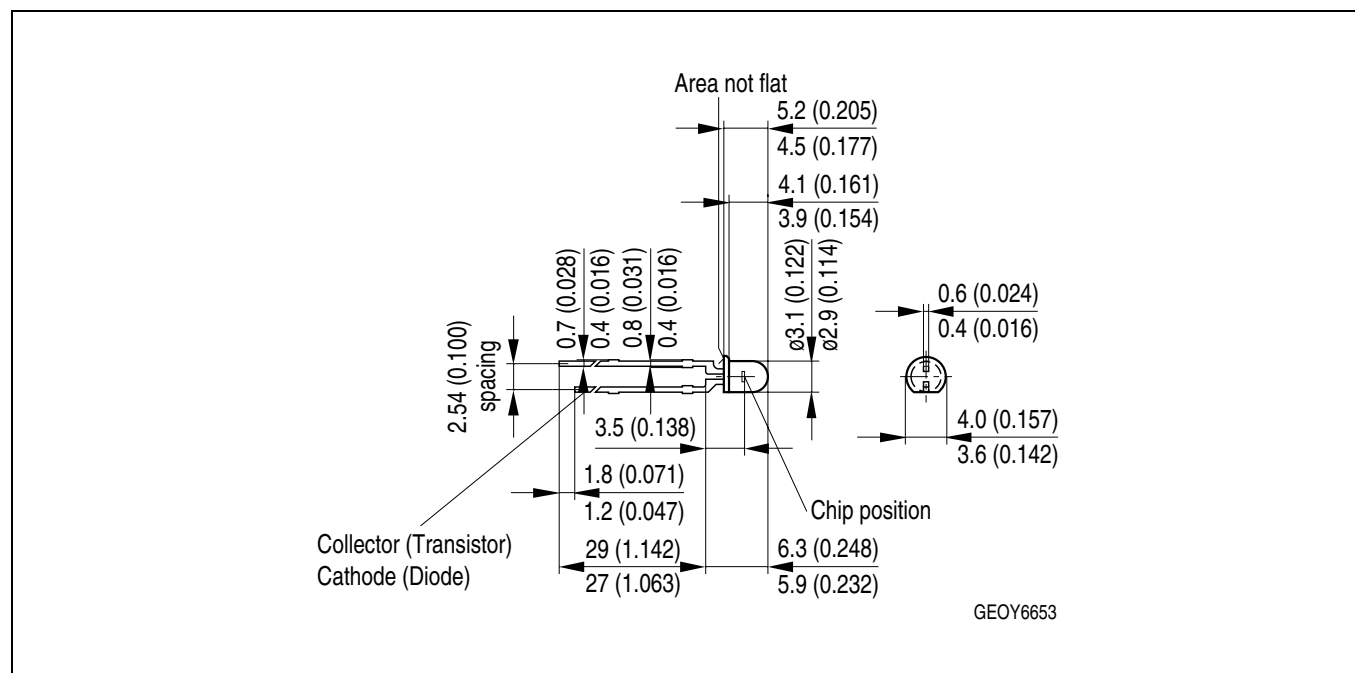

Maße in mm (inch) / Dimensions in mm (inch)

**Empfohlenes Lötpaddesign Wellenlöten (TTW)
Recommended Solder Pad TTW Soldering**

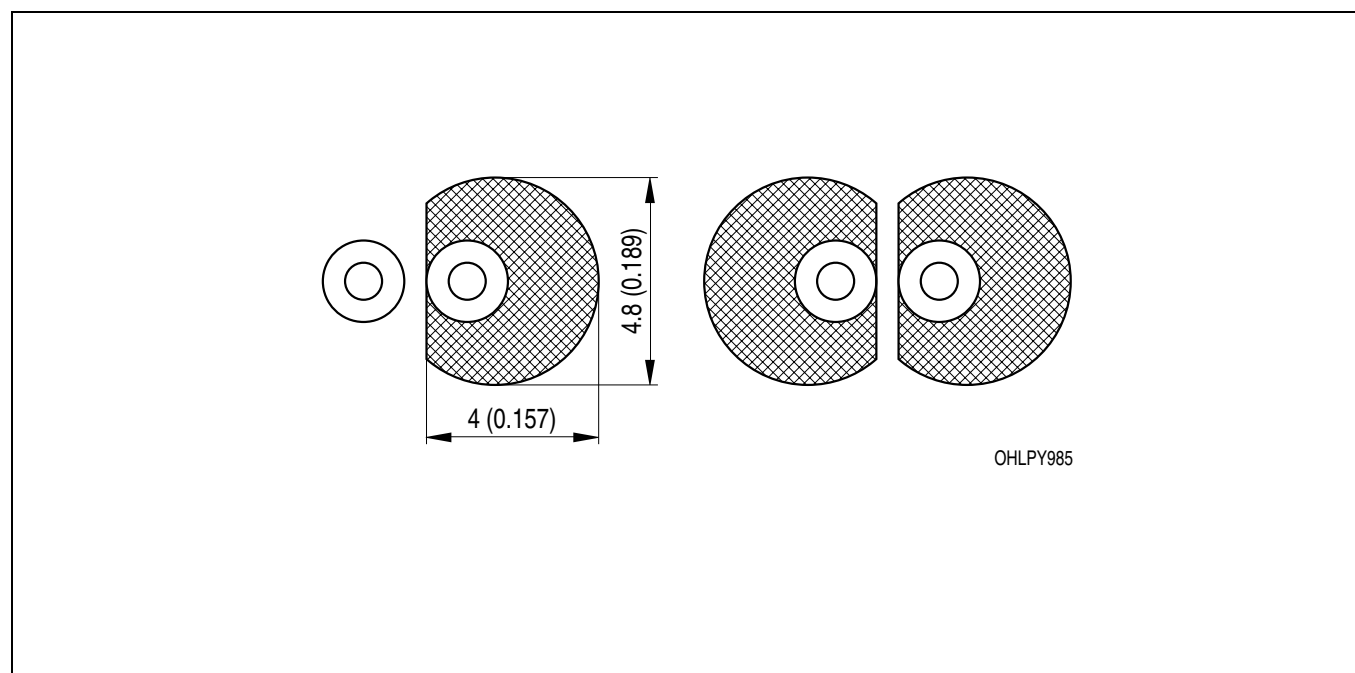

Maße in mm (inch) / Dimensions in mm (inch)

Lötbedingungen
Soldering Conditions
Wellenlöten TTW (nach CECC 00802)
TTW Soldering (acc. to CECC 00802)

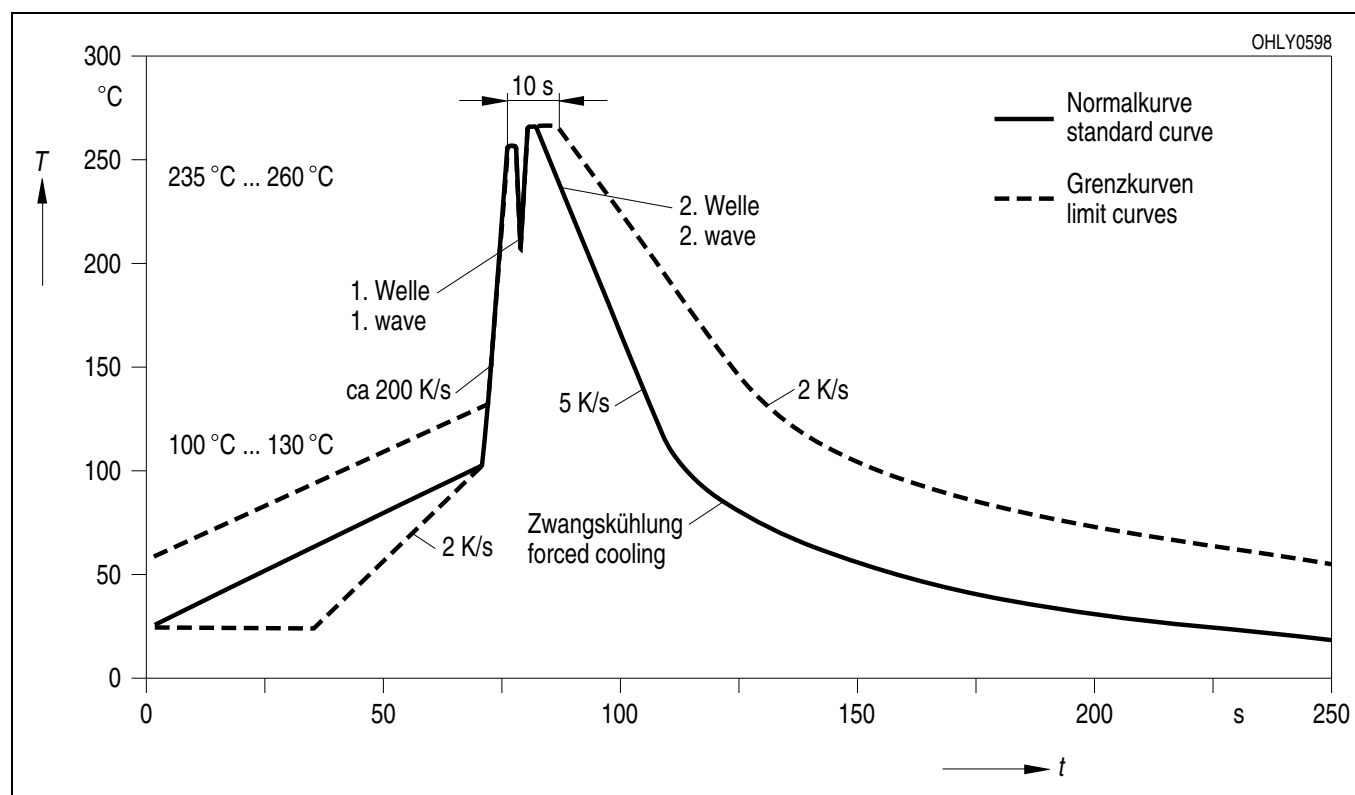

Published by
OSRAM Opto Semiconductors GmbH
 Wernerwerkstrasse 2, D-93049 Regensburg
www.osram-os.com

© All Rights Reserved.

The information describes the type of component and shall not be considered as assured characteristics. Terms of delivery and rights to change design reserved. Due to technical requirements components may contain dangerous substances. For information on the types in question please contact our Sales Organization.

Packing

Please use the recycling operators known to you. We can also help you – get in touch with your nearest sales office. By agreement we will take packing material back, if it is sorted. You must bear the costs of transport. For packing material that is returned to us unsorted or which we are not obliged to accept, we shall have to invoice you for any costs incurred.

Components used in life-support devices or systems must be expressly authorized for such purpose! Critical components¹, may only be used in life-support devices or systems² with the express written approval of OSRAM OS.

¹ A critical component is a component used in a life-support device or system whose failure can reasonably be expected to cause the failure of that life-support device or system, or to affect its safety or effectiveness of that device or system.

² Life support devices or systems are intended (a) to be implanted in the human body, or (b) to support and/or maintain and sustain human life. If they fail, it is reasonable to assume that the health of the user may be endangered.

EU RoHS and China RoHS compliant product



此产品符合欧盟 RoHS 指令的要求；

按照中国的相关法规和标准，不含有毒有害物质或元素。