



# Complete Quad, 16-Bit, High Accuracy, Serial Input, Bipolar Voltage Output DAC

Enhanced Product

**AD5764-EP**

## FEATURES

- Complete quad, 16-bit digital-to-analog converter (DAC)
- Programmable output range:  $\pm 10\text{ V}$ ,  $\pm 10.2564\text{ V}$ , or  $\pm 10.5263\text{ V}$
- $\pm 2$  LSB maximum INL error,  $\pm 1$  LSB maximum DNL error
- Low noise:  $60\text{ nV}/\sqrt{\text{Hz}}$
- Settling time:  $10\text{ }\mu\text{s}$  maximum
- Integrated reference buffers
- Output control during power-up/brownout
- Programmable short-circuit protection
- Simultaneous updating via  $\overline{\text{LDAC}}$
- Asynchronous  $\overline{\text{CLR}}$  to zero code
- Digital offset and gain adjust
- Logic output control pins
- DSP-/microcontroller-compatible serial interface
- Temperature range:  $-55^\circ\text{C}$  to  $+105^\circ\text{C}$
- iCMOS process technology<sup>1</sup>

## ENHANCED PRODUCT FEATURES

- Supports defense and aerospace applications (AQEC standard)
- Extended temperature range:  $-55^\circ\text{C}$  to  $+105^\circ\text{C}$
- Controlled manufacturing baseline
- One assembly/test site
- One fabrication site
- Enhanced product change notification
- Qualification data available on request

## APPLICATIONS

- Industrial automation
- Open-loop/closed-loop servo control
- Process control
- Data acquisition systems
- Automatic test equipment
- Automotive test and measurement
- High accuracy instrumentation

## GENERAL DESCRIPTION

The [AD5764-EP](#) is a quad, 16-bit, serial input, bipolar voltage output DAC that operates from supply voltages of  $\pm 11.4\text{ V}$  to  $\pm 16.5\text{ V}$ . The nominal full-scale output range is  $\pm 10\text{ V}$ . The [AD5764-EP](#) provides integrated output amplifiers, reference buffers, and proprietary power-up/power-down control circuitry. The device also features a digital I/O port that is programmed via the serial interface. The [AD5764-EP](#) incorporates digital offset and gain adjust registers per channel.

The [AD5764-EP](#) is a high performance converter that offers guaranteed monotonicity, integral nonlinearity (INL) of  $\pm 2$  LSB, low noise, and  $10\text{ }\mu\text{s}$  settling time. During power-up (when the supply voltages are changing),  $\text{VOUTx}$  is clamped to  $0\text{ V}$  via a low impedance path.

The [AD5764-EP](#) uses a serial interface that operates at clock rates of up to  $30\text{ MHz}$  and is compatible with DSP and microcontroller interface standards. Double buffering allows the simultaneous updating of all DACs. The input coding is programmable to either twos complement or offset binary format. The asynchronous clear function clears the data register to either bipolar zero or zero scale depending on the coding used. The [AD5764-EP](#) is ideal for both closed-loop servo control and open-loop control applications. The [AD5764-EP](#) is available in a 32-lead TQFP and offers guaranteed specifications over the  $-55^\circ\text{C}$  to  $+105^\circ\text{C}$  industrial temperature range. See Figure 1 for the functional block diagram.

Additional application and technical information can be found in the [AD5764](#) data sheet.

Table 1. Related Devices

Part No.	Description
<a href="#">AD5764R</a>	<a href="#">AD5764</a> with internal voltage reference
<a href="#">AD5744R</a>	Complete quad, 14-bit, high accuracy, serial input, bipolar voltage output DAC with internal voltage reference

<sup>1</sup> For analog systems designers within industrial/instrumentation equipment OEMs who need high performance ICs at higher voltage levels, iCMOS® is a technology platform that enables the development of analog ICs capable of  $30\text{ V}$  and operating at  $\pm 15\text{ V}$  supplies, allowing dramatic reductions in power consumption and package size, and increased ac and dc performance.

Rev. 0

[Document Feedback](#)

Information furnished by Analog Devices is believed to be accurate and reliable. However, no responsibility is assumed by Analog Devices for its use, nor for any infringements of patents or other rights of third parties that may result from its use. Specifications subject to change without notice. No license is granted by implication or otherwise under any patent or patent rights of Analog Devices. Trademarks and registered trademarks are the property of their respective owners.

One Technology Way, P.O. Box 9106, Norwood, MA 02062-9106, U.S.A.  
Tel: 781.329.4700 ©2013 Analog Devices, Inc. All rights reserved.  
[Technical Support](#) [www.analog.com](http://www.analog.com)

**TABLE OF CONTENTS**

Features .....	1	Timing Characteristics .....	6
Enhanced Product Features .....	1	Absolute Maximum Ratings .....	9
Applications.....	1	ESD Caution.....	9
General Description .....	1	Pin Configuration and Function Descriptions.....	10
Revision History .....	2	Typical Performance Characteristics .....	12
Functional Block Diagram .....	3	Outline Dimensions .....	17
Specifications.....	4	Ordering Guide .....	17
AC Performance Characteristics .....	5		

**REVISION HISTORY**

**12/13—Revision 0: Initial Version**

# FUNCTIONAL BLOCK DIAGRAM

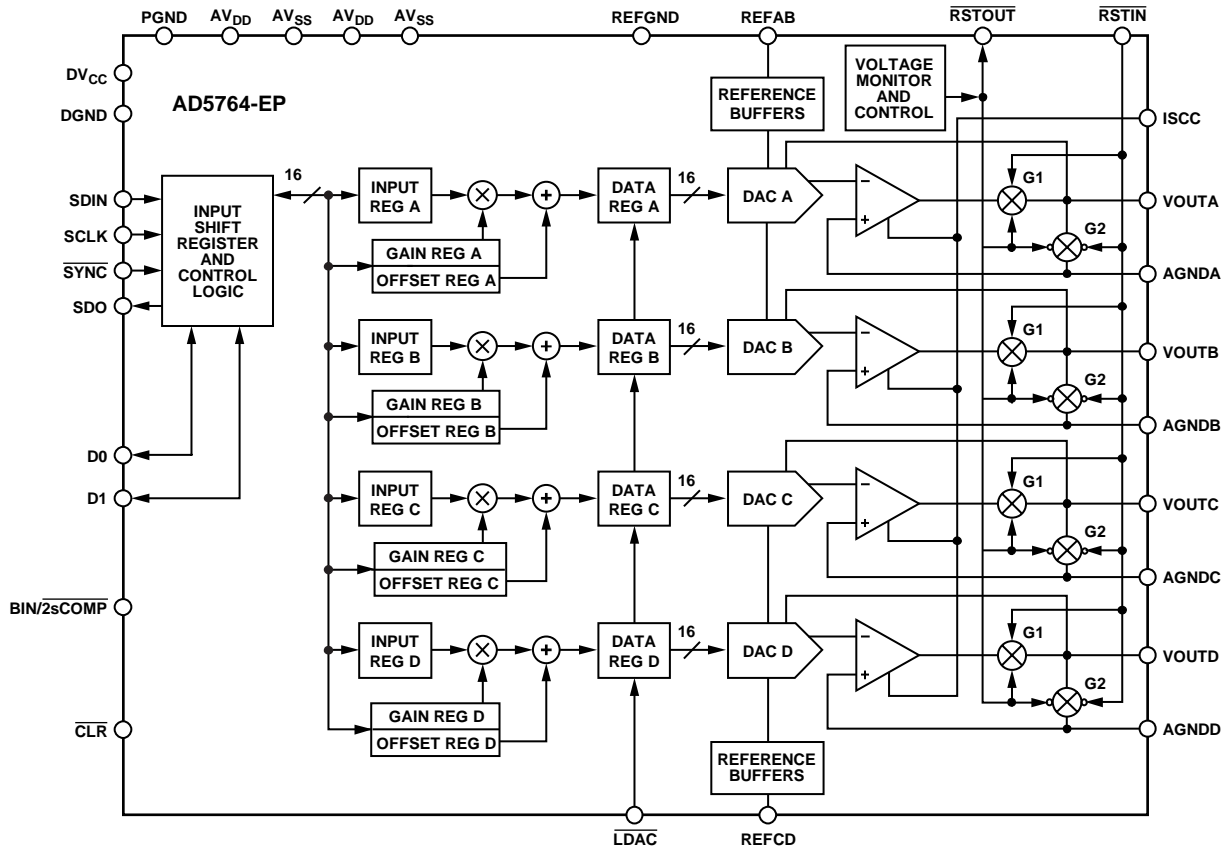

Figure 1.

11843-001

## SPECIFICATIONS

$AV_{DD} = 11.4\text{ V to }16.5\text{ V}$ ,  $AV_{SS} = -11.4\text{ V to }-16.5\text{ V}$ ,  $AGND_x = DGND = REFGND = PGND = 0\text{ V}$ ;  $REFAB = REFCD = 5\text{ V}$ ;  
 $DV_{CC} = 2.7\text{ V to }5.25\text{ V}$ ,  $R_{LOAD} = 10\text{ k}\Omega$ ,  $C_{LOAD} = 200\text{ pF}$ . Temperature range:  $-55^\circ\text{C to }+105^\circ\text{C}$ ; typical at  $+25^\circ\text{C}$ . All specifications  
 $T_{MIN}$  to  $T_{MAX}$ , unless otherwise noted.

Table 2.

Parameter	Min	Typ	Max	Unit	Test Conditions/Comments
ACCURACY					Outputs unloaded
Resolution	16			Bits	
Relative Accuracy (INL)			$\pm 2$	LSB	
Differential Nonlinearity (DNL)			$\pm 1$	LSB	Guaranteed monotonic
Bipolar Zero Error			$\pm 2$	mV	At $25^\circ\text{C}$ ; error at other temperatures obtained using bipolar zero TC
Bipolar Zero Temperature Coefficient (TC) <sup>1</sup>			$\pm 2$	ppm FSR/ $^\circ\text{C}$	
Zero-Scale Error			$\pm 3$	mV	At $25^\circ\text{C}$ ; error at other temperatures obtained using zero-scale TC
Zero-Scale TC <sup>1</sup>			$\pm 2$	ppm FSR/ $^\circ\text{C}$	
Gain Error			$\pm 0.02$	% FSR	At $25^\circ\text{C}$ ; error at other temperatures obtained using gain TC
Gain TC <sup>1</sup>			$\pm 2$	ppm FSR/ $^\circ\text{C}$	
DC Crosstalk <sup>1</sup>			0.5	LSB	
REFERENCE INPUT <sup>1</sup>					
Reference Input Voltage		5		V	$\pm 1\%$ for specified performance
DC Input Impedance	1			M $\Omega$	Typically 100 M $\Omega$
Input Current			$\pm 10$	$\mu\text{A}$	Typically $\pm 30\text{ nA}$
Reference Range	1		7	V	
OUTPUT CHARACTERISTICS <sup>1</sup>					
Output Voltage Range <sup>2</sup>	$-10.5263$		$+10.5263$	V	$AV_{DD}/AV_{SS} = \pm 11.4\text{ V}$ , $V_{REFIN} = 5\text{ V}$
	$-14$		$+14$	V	$AV_{DD}/AV_{SS} = \pm 16.5\text{ V}$ , $V_{REFIN} = 7\text{ V}$
Output Voltage Drift vs. Time		$\pm 13$		ppm FSR/ 500 hours	
		$\pm 15$		ppm FSR/ 1000 hours	
Short-Circuit Current		10		mA	$R_{ISCC} = 6\text{ k}\Omega$ ; see Figure 31
Load Current			$\pm 1$	mA	For specified performance
Capacitive Load Stability					
$R_{LOAD} = \infty$			200	pF	
$R_{LOAD} = 10\text{ k}\Omega$			1000	pF	
DC Output Impedance			0.3	$\Omega$	
DIGITAL INPUTS					$DV_{CC} = 2.7\text{ V to }5.25\text{ V}$ , JEDEC compliant
Input High Voltage, $V_{IH}$	2			V	
Input Low Voltage, $V_{IL}$			0.8	V	
Input Current			$\pm 1$	$\mu\text{A}$	Per pin
Pin Capacitance			10	pF	Per pin
DIGITAL OUTPUTS (D0, D1, SDO) <sup>1</sup>					
Output Low Voltage, $V_{OL}$			0.4	V	$DV_{CC} = 5\text{ V} \pm 5\%$ , sinking 200 $\mu\text{A}$
			0.4	V	$DV_{CC} = 2.7\text{ V to }3.6\text{ V}$ , sinking 200 $\mu\text{A}$
Output High Voltage, $V_{OH}$	$DV_{CC} - 1$			V	$DV_{CC} = 5\text{ V} \pm 5\%$ , sourcing 200 $\mu\text{A}$
	$DV_{CC} - 0.5$			V	$DV_{CC} = 2.7\text{ V to }3.6\text{ V}$ , sourcing 200 $\mu\text{A}$
High Impedance Leakage Current			$\pm 1$	$\mu\text{A}$	SDO only
High Impedance Output Capacitance		5		pF	SDO only

Parameter	Min	Typ	Max	Unit	Test Conditions/Comments
<b>POWER REQUIREMENTS</b>					
$AV_{DD}/AV_{SS}$	$\pm 11.4$		$\pm 16.5$	V	
$DV_{CC}$	2.7		5.25	V	
Power Supply Sensitivity <sup>1</sup>					
$\Delta V_{OUT}/\Delta AV_{DD}$		-85		dB	
$I_{DD}$			3.75	mA/channel	Outputs unloaded
$I_{SS}$			-3	mA/channel	Outputs unloaded
$D_{I_{CC}}$			1.4	mA	$V_{IH} = DV_{CC}$ , $V_{IL} = DGND$ , 750 $\mu A$ typical
Power Dissipation		275		mW	$\pm 12 V$ operation, output unloaded

<sup>1</sup> Guaranteed by design and characterization; not production tested.

<sup>2</sup> Output amplifier headroom requirement is 1.4 V minimum.

### AC PERFORMANCE CHARACTERISTICS

$AV_{DD} = 11.4 V$  to  $16.5 V$ ,  $AV_{SS} = -11.4 V$  to  $-16.5 V$ ,  $AGND_x = DGND = REF_{GND} = PGND = 0 V$ ;  $REF_{AB} = REF_{CD} = 5 V$ ;  $DV_{CC} = 2.7 V$  to  $5.25 V$ ,  $R_{LOAD} = 10 k\Omega$ ,  $C_{LOAD} = 200 pF$ . All specifications  $T_{MIN}$  to  $T_{MAX}$ , unless otherwise noted.

Table 3.

Parameter	Min	Typ	Max	Unit	Test Conditions/Comments
<b>DYNAMIC PERFORMANCE<sup>1</sup></b>					
Output Voltage Settling Time		8	10	$\mu s$	Full-scale step to $\pm 1$ LSB
		2		$\mu s$	512 LSB step settling
Slew Rate		5		V/ $\mu s$	
Digital-to-Analog Glitch Energy		8		nV-sec	
Glitch Impulse Peak Amplitude			37	mV p-p	
Channel-to-Channel Isolation		80		dB	
DAC-to-DAC Crosstalk		8		nV-sec	
Digital Crosstalk		2		nV-sec	
Digital Feedthrough		2		nV-sec	Effect of input bus activity on DAC outputs
Output Noise					
0.1 Hz to 10 Hz		0.1		LSB p-p	
0.1 Hz to 100 kHz			45	$\mu V$ rms	
1/f Corner Frequency		1		kHz	
Output Noise Spectral Density		60		nV/ $\sqrt{Hz}$	Measured at 10 kHz
Complete System Output Noise Spectral Density <sup>2</sup>		80		nV/ $\sqrt{Hz}$	Measured at 10 kHz

<sup>1</sup> Guaranteed by design and characterization; not production tested.

<sup>2</sup> Includes noise contributions from integrated reference buffers, 16-bit DAC, and output amplifier.

## TIMING CHARACTERISTICS

$AV_{DD} = 11.4\text{ V to }16.5\text{ V}$ ,  $AV_{SS} = -11.4\text{ V to }-16.5\text{ V}$ ,  $AGND_x = DGND = REFGND = PGND = 0\text{ V}$ ;  $REFAB = REFCD = 5\text{ V}$ ;  
 $DV_{CC} = 2.7\text{ V to }5.25\text{ V}$ ,  $R_{LOAD} = 10\text{ k}\Omega$ ,  $C_{LOAD} = 200\text{ pF}$ . All specifications  $T_{MIN}$  to  $T_{MAX}$ , unless otherwise noted.

Table 4.

Parameter <sup>1, 2, 3</sup>	Limit at $T_{MIN}$ , $T_{MAX}$	Unit	Description
$t_1$	33	ns min	SCLK cycle time
$t_2$	13	ns min	SCLK high time
$t_3$	13	ns min	SCLK low time
$t_4$	13	ns min	$\overline{\text{SYNC}}$ falling edge to SCLK falling edge setup time
$t_5^4$	13	ns min	24 <sup>th</sup> SCLK falling edge to $\overline{\text{SYNC}}$ rising edge
$t_6$	90	ns min	Minimum $\overline{\text{SYNC}}$ high time
$t_7$	2	ns min	Data setup time
$t_8$	9	ns min	Data hold time
$t_9$	1.7	$\mu\text{s min}$	$\overline{\text{SYNC}}$ rising edge to $\overline{\text{LDAC}}$ falling edge (all DACs updated)
	480	ns min	$\overline{\text{SYNC}}$ rising edge to $\overline{\text{LDAC}}$ falling edge (single DAC updated)
$t_{10}$	17	ns min	$\overline{\text{LDAC}}$ pulse width low
$t_{11}$	500	ns max	$\overline{\text{LDAC}}$ falling edge to DAC output response time
$t_{12}$	10	$\mu\text{s max}$	DAC output settling time
$t_{13}$	17	ns min	$\overline{\text{CLR}}$ pulse width low
$t_{14}$	2	$\mu\text{s max}$	$\overline{\text{CLR}}$ pulse activation time
$t_{15}^{5, 6}$	25	ns max	SCLK rising edge to SDO valid
$t_{16}$	13	ns min	$\overline{\text{SYNC}}$ rising edge to SCLK falling edge
$t_{17}$	2	$\mu\text{s max}$	$\overline{\text{SYNC}}$ rising edge to DAC output response time ( $\overline{\text{LDAC}} = 0$ )
$t_{18}$	170	ns min	$\overline{\text{LDAC}}$ falling edge to $\overline{\text{SYNC}}$ rising edge

<sup>1</sup> Guaranteed by design and characterization; not production tested.

<sup>2</sup> All input signals are specified with  $t_R = t_F = 5\text{ ns}$  (10% to 90% of  $DV_{CC}$ ) and timed from a voltage level of 1.2 V.

<sup>3</sup> See Figure 3, Figure 4, and Figure 5.

<sup>4</sup> Standalone mode only.

<sup>5</sup> Measured with the load circuit of Figure 2.

<sup>6</sup> Daisy-chain mode only.

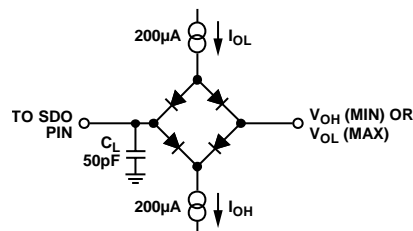
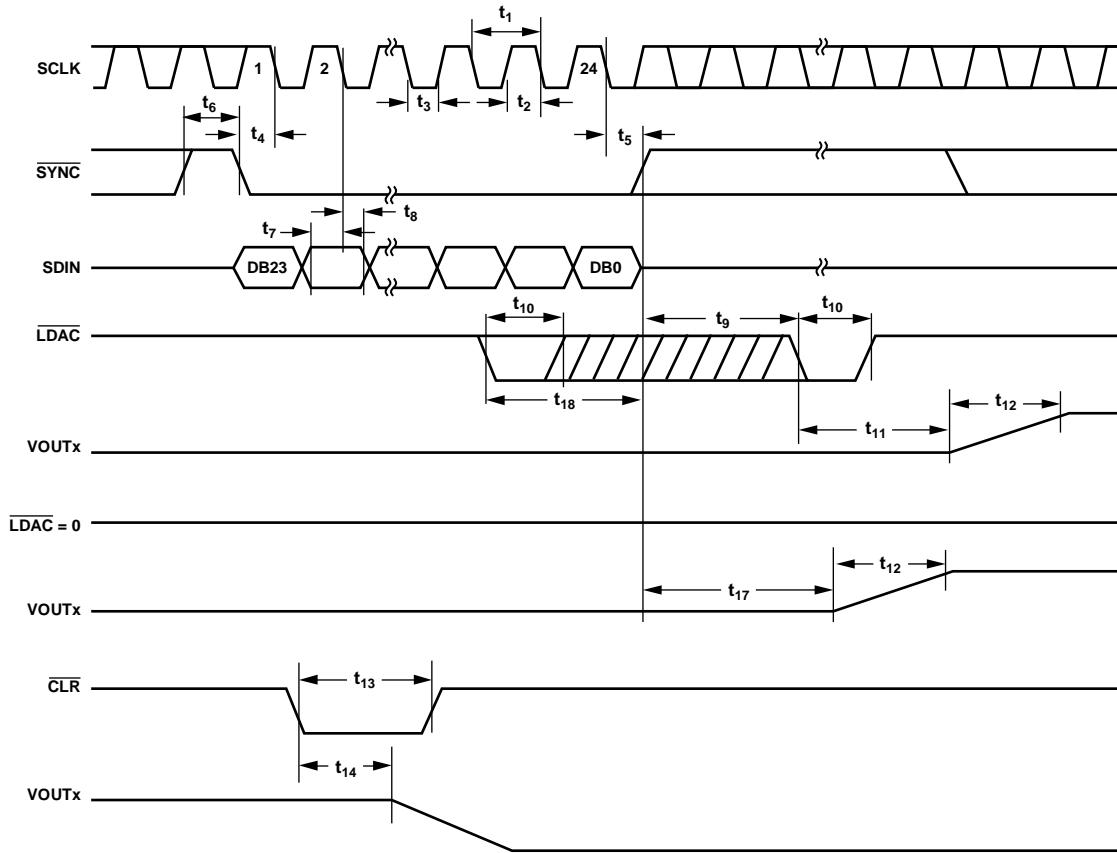

Figure 2. Load Circuit for SDO Timing Diagram

11843-005

Timing Diagrams



11843-002

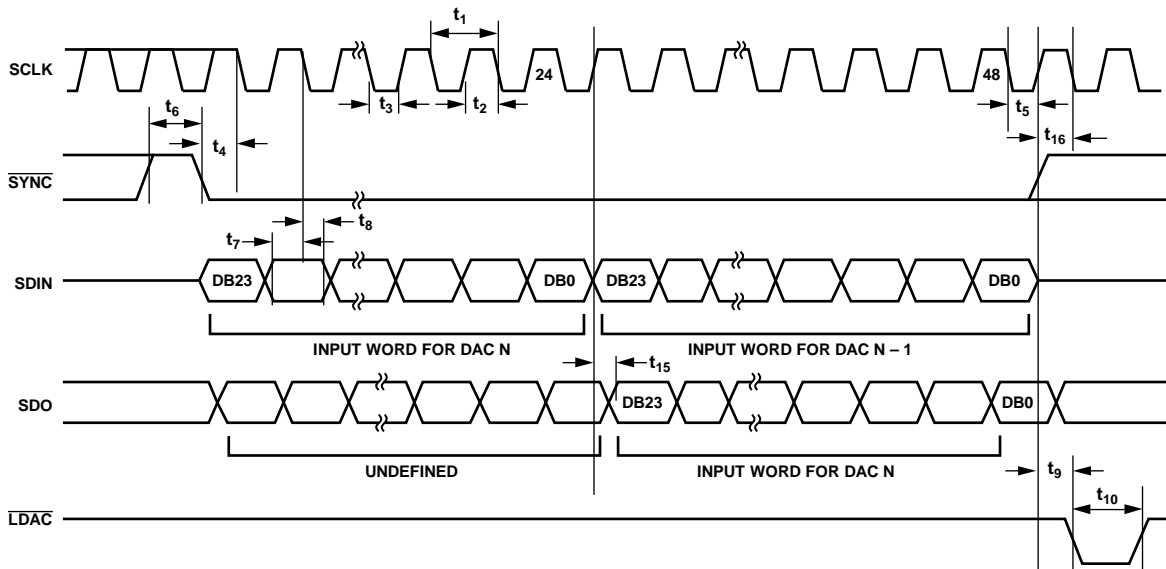

11843-003

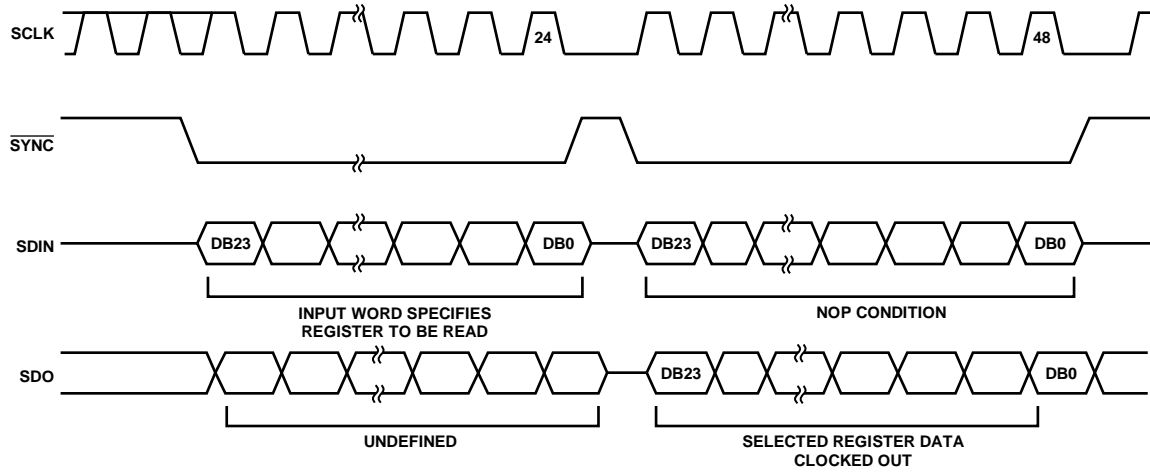

Figure 5. Readback Timing Diagram

11843-004



## ABSOLUTE MAXIMUM RATINGS

$T_A = 25^\circ\text{C}$ , unless otherwise noted. Transient currents of up to 100 mA do not cause SCR latch-up.

Table 5.

Parameter	Rating
$AV_{DD}$ to AGNDx, DGND	-0.3 V to +17 V
$AV_{SS}$ to AGNDx, DGND	+0.3 V to -17 V
$DV_{CC}$ to DGND	-0.3 V to +7 V
Digital Inputs to DGND	-0.3 V to $DV_{CC} + 0.3$ V or 7 V (whichever is less)
Digital Outputs to DGND	-0.3 V to $DV_{CC} + 0.3$ V
REFAB, REFCD to AGNDx, PGND	-0.3 V to $AV_{DD} + 0.3$ V
VOUTA, VOUTB, VOUTC, VOUTD to AGNDx	$AV_{SS}$ to $AV_{DD}$
AGNDx to DGND	-0.3 V to +0.3 V
Operating Temperature Range	
Industrial	-55°C to +105°C
Storage Temperature Range	-65°C to +150°C
Junction Temperature ( $T_J$ max)	150°C
32-Lead TQFP	
$\theta_{JA}$ Thermal Impedance	65°C/W
$\theta_{JC}$ Thermal Impedance	12°C/W
Lead Temperature	JEDEC industry standard
Soldering	J-STD-020

Stresses above those listed under Absolute Maximum Ratings may cause permanent damage to the device. This is a stress rating only; functional operation of the device at these or any other conditions above those indicated in the operational section of this specification is not implied. Exposure to absolute maximum rating conditions for extended periods may affect device reliability.

### ESD CAUTION



**ESD (electrostatic discharge) sensitive device.** Charged devices and circuit boards can discharge without detection. Although this product features patented or proprietary protection circuitry, damage may occur on devices subjected to high energy ESD. Therefore, proper ESD precautions should be taken to avoid performance degradation or loss of functionality.

## PIN CONFIGURATION AND FUNCTION DESCRIPTIONS

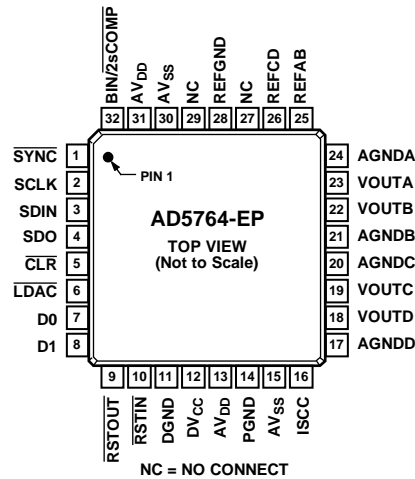

Figure 6. Pin Configuration

Table 6. Pin Function Descriptions

Pin No.	Mnemonic	Description
1	SYNC	Active Low Input. This pin is the frame synchronization signal for the serial interface. While SYNC is low, data is transferred in on the falling edge of SCLK.
2	SCLK	Serial Clock Input. Data is clocked into the input shift register on the falling edge of SCLK. This input operates at clock speeds up to 30 MHz.
3	SDIN	Serial Data Input. Data must be valid on the falling edge of SCLK.
4	SDO	Serial Data Output. This pin is used to clock data from the serial register in daisy-chain or readback mode.
5	CLR	Negative Edge Triggered Input. Asserting this pin sets the data register to 0x0000. This logic input has an internal pull-up device. Therefore, this pin can be left floating and defaults to a Logic 1 condition.
6	LDAC	Load DAC. This logic input is used to update the data register and, consequently, the analog outputs. When LDAC is tied permanently low, the addressed data register is updated on the rising edge of SYNC. If LDAC is held high during the write cycle, the DAC input shift register is updated, but the update of the output is delayed until the falling edge of LDAC. In this mode, all analog outputs can be updated simultaneously on the falling edge of LDAC. The LDAC pin must not be left unconnected.
7, 8	D0, D1	Digital I/O Port. These pins can be inputs or outputs that are configurable and readable over the serial interface. When configured as inputs, D0 and D1 have weak internal pull-ups to DV <sub>CC</sub> . When configured as outputs, D0 and D1 are referenced by DV <sub>CC</sub> and DGND.
9	RSTOUT	Reset Logic Output. This pin is the output from the on-chip voltage monitor and is used in the reset circuit. If desired, this pin can be used to control other system components.
10	RSTIN	Reset Logic Input. This input allows external access to the internal reset logic. Applying a Logic 0 to this input clamps the DAC outputs to 0 V. In normal operation, RSTIN should be tied to Logic 1. Register values remain unchanged.
11	DGND	Digital Ground.
12	DV <sub>CC</sub>	Digital Supply Voltage (2.7 V to 5.25 V).
13, 31	AV <sub>DD</sub>	Positive Analog Supply Voltage (11.4 V to 16.5 V).
14	PGND	Ground Reference Point for the Analog Circuitry.
15, 30	AV <sub>SS</sub>	Negative Analog Supply Voltage (–11.4 V to –16.5 V).
16	ISCC	Resistor Connection for Pin Programmable Short-Circuit Current. This pin is used with an optional external resistor to AGND to program the short-circuit current of the output amplifiers.
17	AGNDD	Ground Reference Pin for DAC D Output Amplifier.
18	VOUTD	Analog Output Voltage of DAC D. This buffered output has a nominal full-scale output range of ±10 V. The output amplifier is capable of directly driving a 10 kΩ, 200 pF load.
19	VOUTC	Analog Output Voltage of DAC C. This buffered output has a nominal full-scale output range of ±10 V. The output amplifier is capable of directly driving a 10 kΩ, 200 pF load.
20	AGNDC	Ground Reference Pin for DAC C Output Amplifier.

Pin No.	Mnemonic	Description
21	AGNDB	Ground Reference Pin for DAC B Output Amplifier.
22	VOUTB	Analog Output Voltage of DAC B. This buffered output has a nominal full-scale output range of $\pm 10$ V. The output amplifier is capable of directly driving a 10 k $\Omega$ , 200 pF load.
23	VOUTA	Analog Output Voltage of DAC A. This buffered output has a nominal full-scale output range of $\pm 10$ V. The output amplifier is capable of directly driving a 10 k $\Omega$ , 200 pF load.
24	AGNDA	Ground Reference Pin for DAC A Output Amplifier.
25	REFAB	External Reference Voltage Input for Channel A and Channel B. Reference input range is 1 V to 7 V. This pin programs the full-scale output voltage. $V_{REFIN} = 5$ V for specified performance.
26	REFCD	External Reference Voltage Input for Channel C and Channel D. Reference input range is 1 V to 7 V. This pin programs the full-scale output voltage. $V_{REFIN} = 5$ V for specified performance.
27, 29	NC	No Connect.
28	REFGND	Reference Ground Return for the Reference Generator and Buffers.
32	$\overline{BIN/2sCOMP}$	This pin determines the DAC coding. This pin should be hardwired to either $DV_{CC}$ or DGND. When the pin is hardwired to $DV_{CC}$ , the input coding is offset binary. When the pin is hardwired to DGND, the input coding is twos complement.

TYPICAL PERFORMANCE CHARACTERISTICS

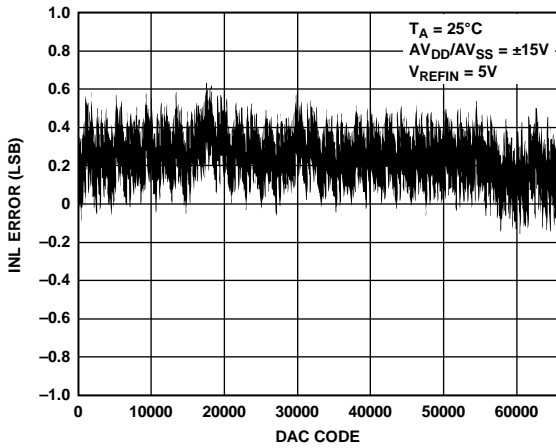

Figure 7. Integral Nonlinearity Error vs. Code,  $AV_{DD}/AV_{SS} = \pm 15 V$

11843-007

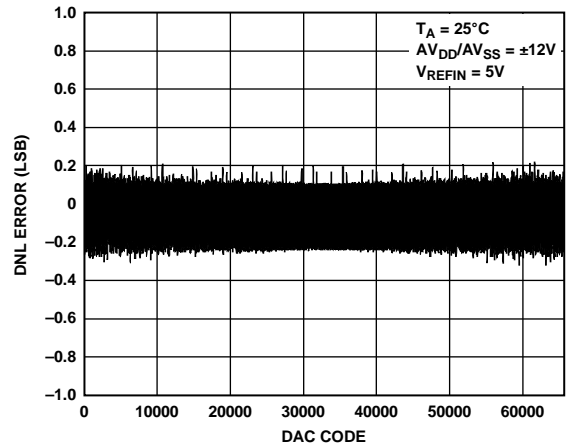

Figure 10. Differential Nonlinearity Error vs. Code,  $AV_{DD}/AV_{SS} = \pm 12 V$

11843-012

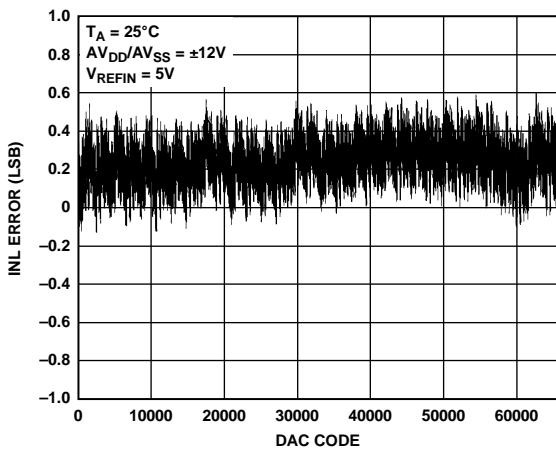

Figure 8. Integral Nonlinearity Error vs. Code,  $AV_{DD}/AV_{SS} = \pm 12 V$

11843-008

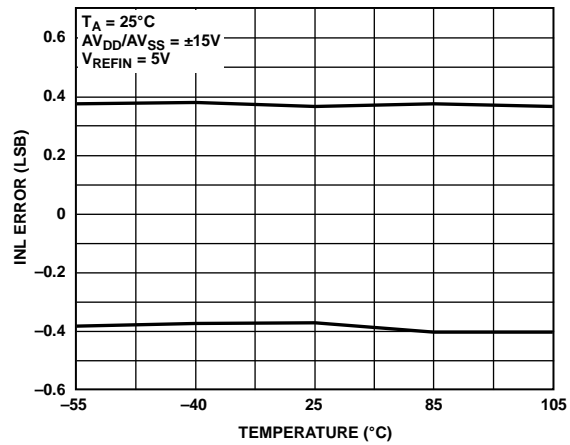

Figure 11. Integral Nonlinearity Error vs. Temperature,  $AV_{DD}/AV_{SS} = \pm 15 V$

11843-111

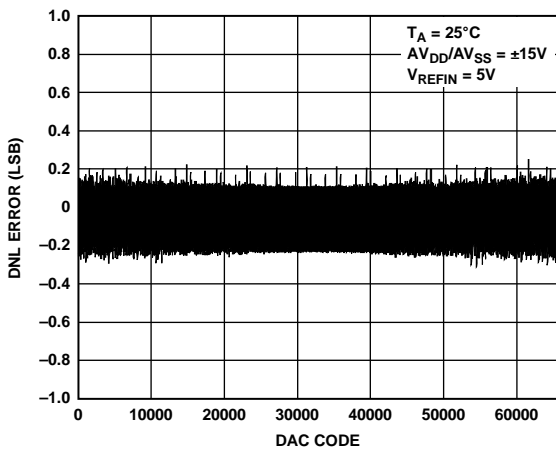

Figure 9. Differential Nonlinearity Error vs. Code,  $AV_{DD}/AV_{SS} = \pm 15 V$

11843-011

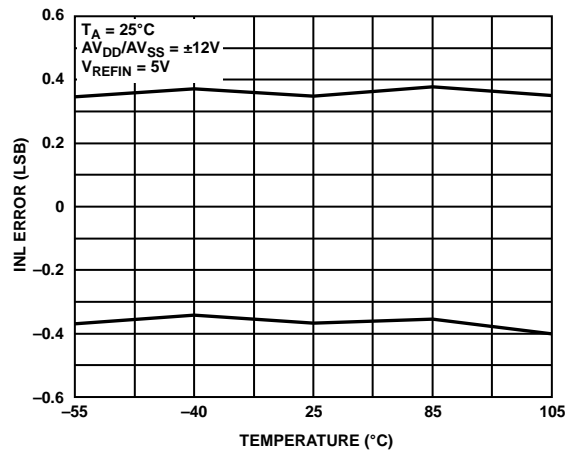

Figure 12. Integral Nonlinearity Error vs. Temperature,  $AV_{DD}/AV_{SS} = \pm 12 V$

11843-112

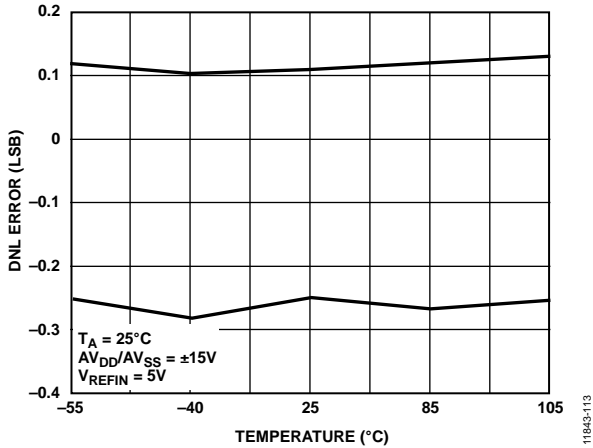

Figure 13. Differential Nonlinearity Error vs. Temperature,  $AV_{DD}/AV_{SS} = \pm 15 V$

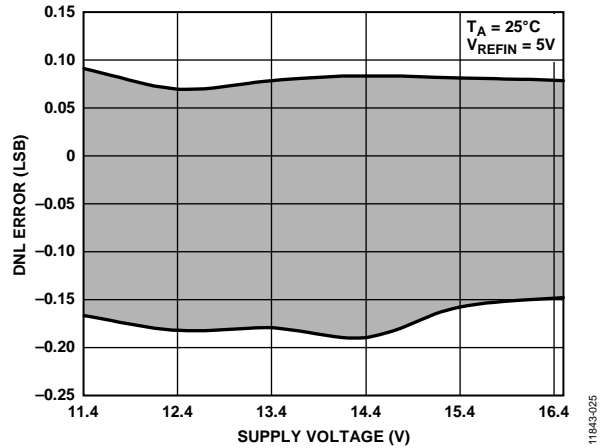

Figure 16. Differential Nonlinearity Error vs. Supply Voltage

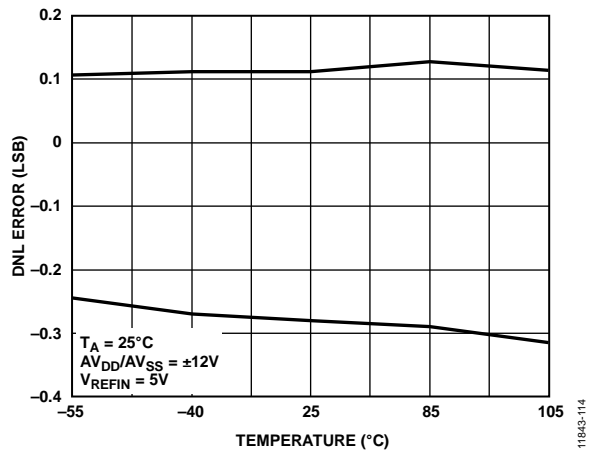

Figure 14. Differential Nonlinearity Error vs. Temperature,  $AV_{DD}/AV_{SS} = \pm 12 V$

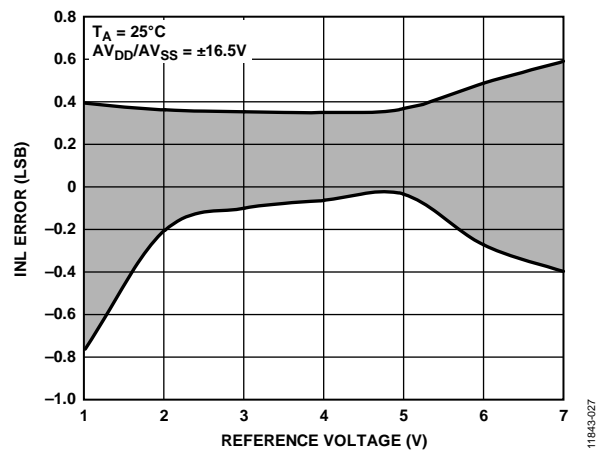

Figure 17. Integral Nonlinearity Error vs. Reference Voltage,  $AV_{DD}/AV_{SS} = \pm 16.5 V$

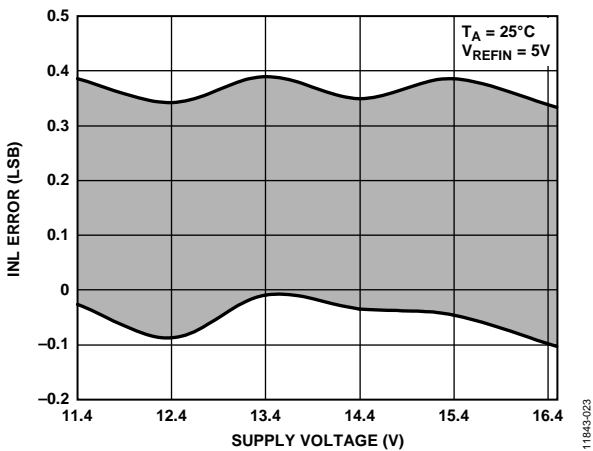

Figure 15. Integral Nonlinearity Error vs. Supply Voltage

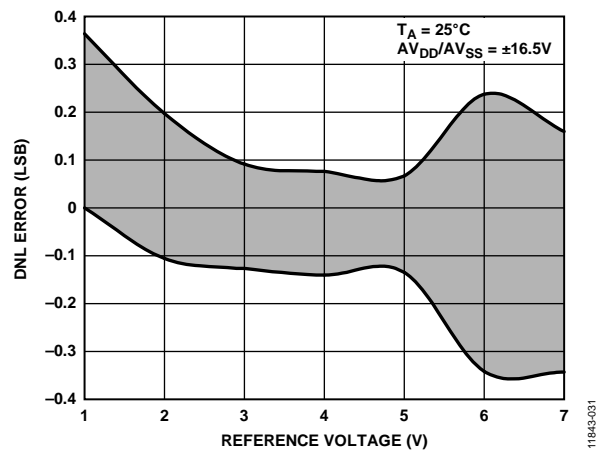

Figure 18. Differential Nonlinearity Error vs. Reference Voltage,  $AV_{DD}/AV_{SS} = \pm 16.5 V$

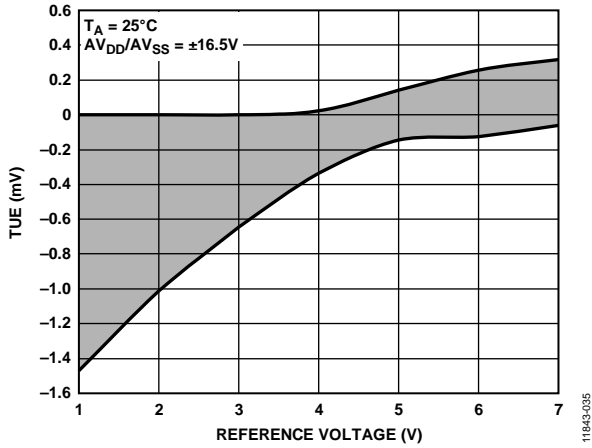

Figure 19. Total Unadjusted Error vs. Reference Voltage,  $AV_{DD}/AV_{SS} = \pm 16.5V$

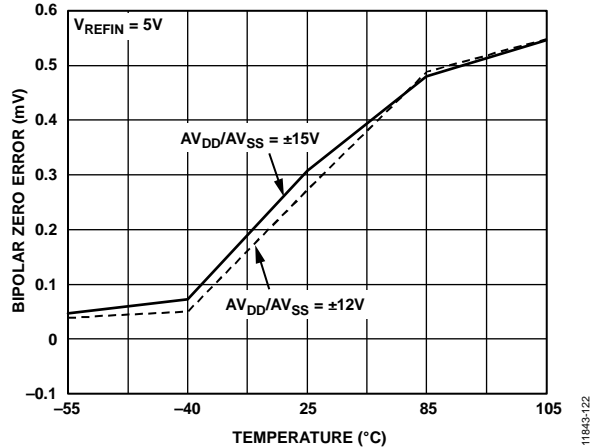

Figure 22. Bipolar Zero Error vs. Temperature

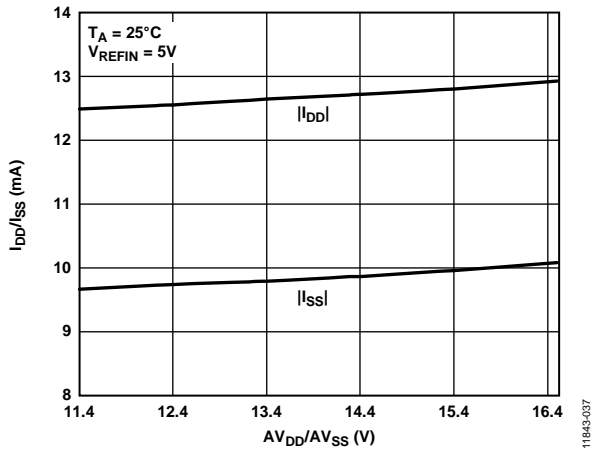

Figure 20.  $I_{DD}/I_{SS}$  vs.  $AV_{DD}/AV_{SS}$

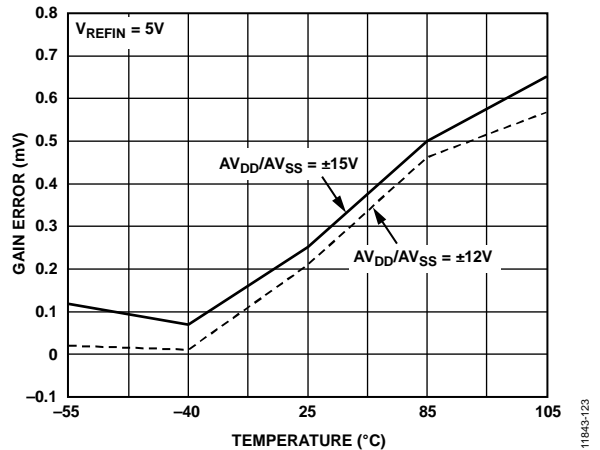

Figure 23. Gain Error vs. Temperature

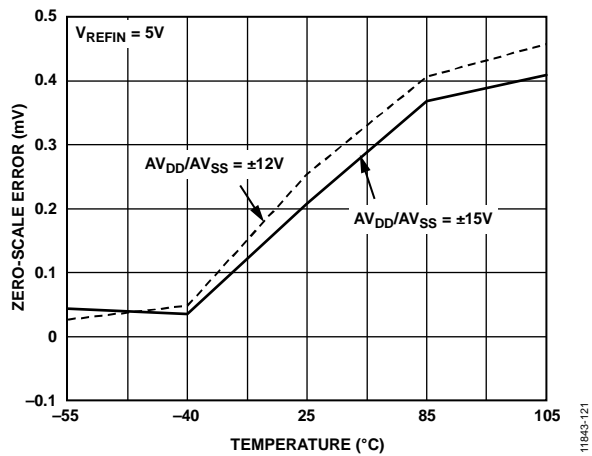

Figure 21. Zero-Scale Error vs. Temperature

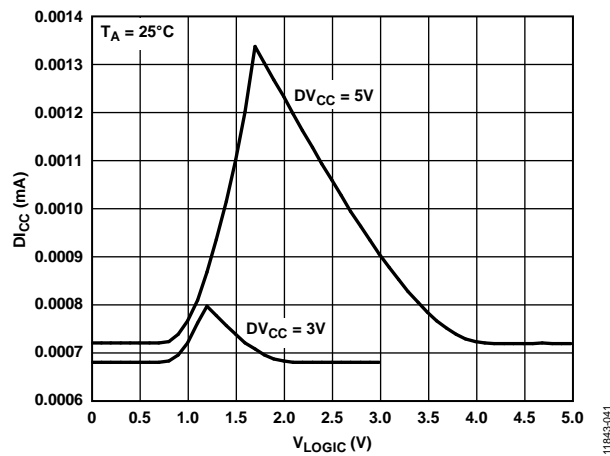

Figure 24.  $D_{Icc}$  vs. Logic Input Voltage

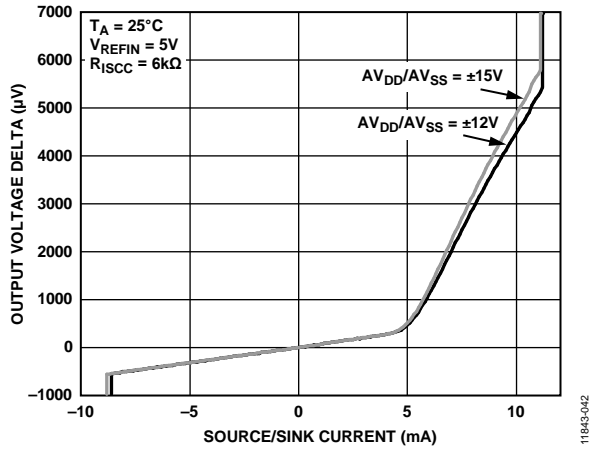

Figure 25. Source and Sink Capability of Output Amplifier with Positive Full Scale Loaded

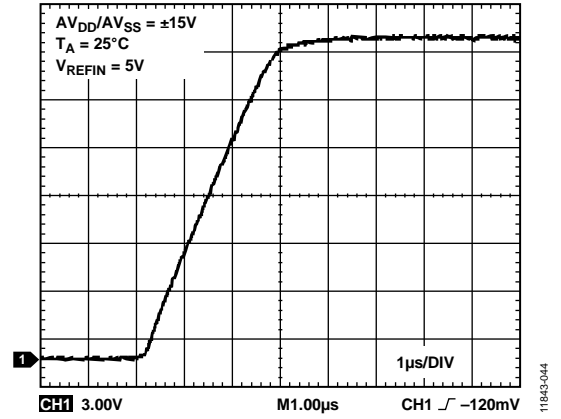

Figure 27. Full-Scale Settling Time

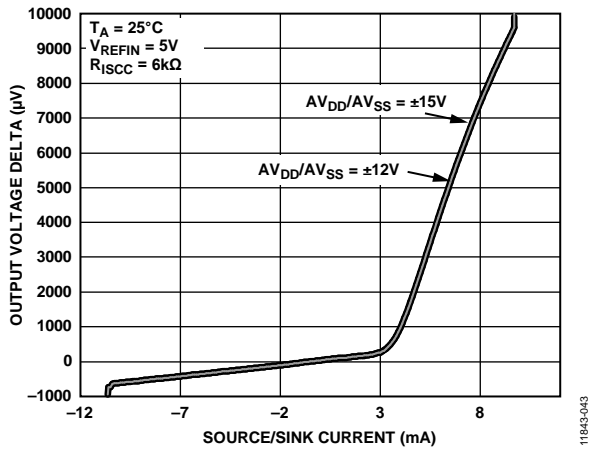

Figure 26. Source and Sink Capability of Output Amplifier with Negative Full Scale Loaded

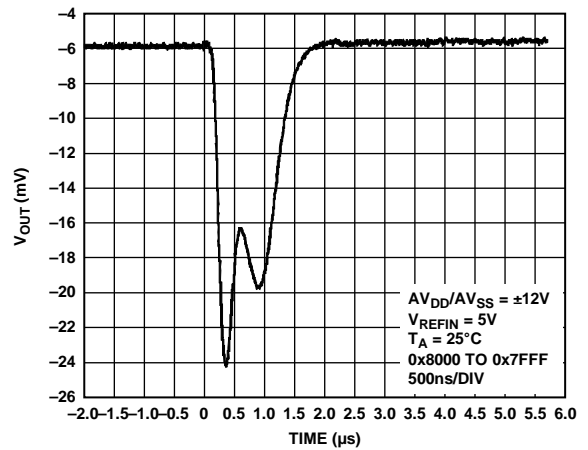

Figure 28. Major Code Transition Glitch Energy,  $AV_{DD}/AV_{SS} = \pm 12\text{V}$

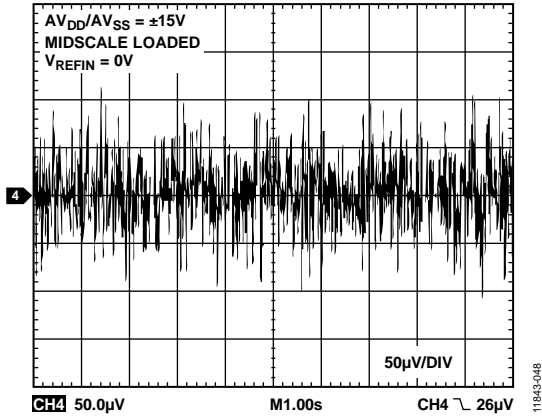

Figure 29. Peak-to-Peak Noise (100 kHz Bandwidth)

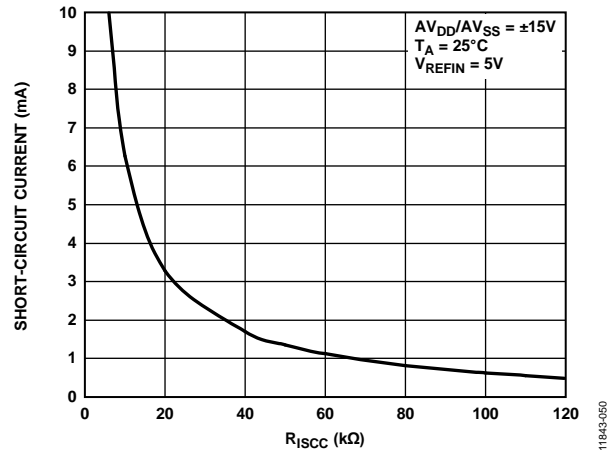

Figure 31. Short-Circuit Current vs. R<sub>ISCC</sub>

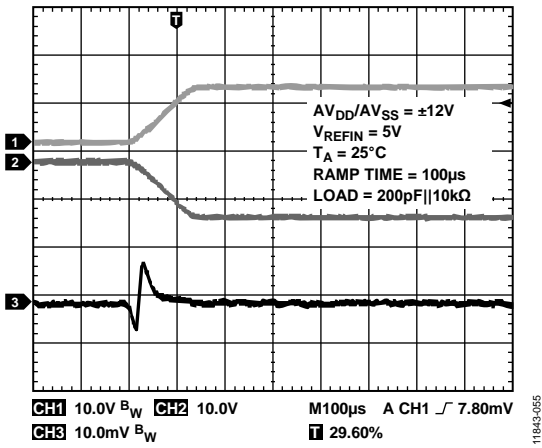
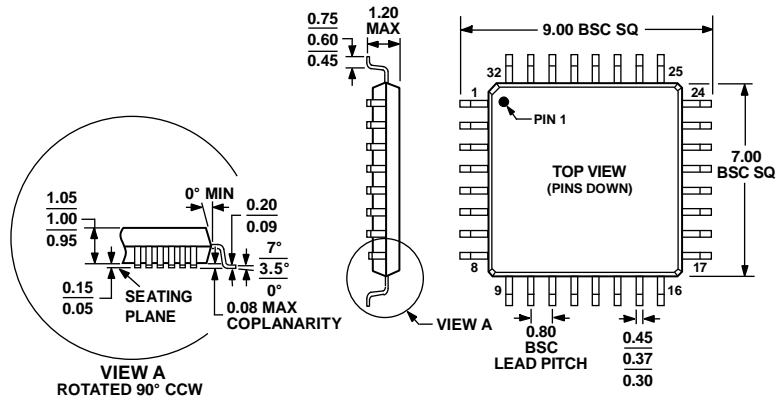

Figure 30. V<sub>OUT</sub> vs. AV<sub>DD</sub>/AV<sub>SS</sub> on Power-Up



# OUTLINE DIMENSIONS



COMPLIANT TO JEDEC STANDARDS MS-026-ABA

Figure 32. 32-Lead Thin Plastic Quad Flat Package [TQFP] (SU-32-2)

Dimensions shown in millimeters

0228607-A

## ORDERING GUIDE

Model <sup>1</sup>	INL	Temperature Range	Package Description	Package Option
AD5764SSUZ-EP-RL7	±2 LSB max	-55°C to +105°C	32-Lead TQFP	SU-32-2

<sup>1</sup> Z = RoHS Compliant Part.

**NOTES**

**NOTES**

**NOTES**