

CGA2B2X5R1H681M050BA

TDK Item Description : CGA2B2X5R1H681MT****



Equivalent C1005X5R1H681M for Automotive

Application & Main Feature

Automotive Grade (General (Up to 50V))

Series

CGA2(1005) [EIA CC0402]

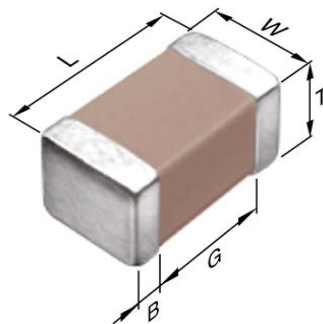

Dimensions

L 1.00mm +/-0.05mm
 W 0.50mm +/-0.05mm
 T 0.50mm +/-0.05mm
 B 0.10mm Min.
 G 0.30mm Min.

Temperature Characteristic

X5R (-55 to 85 degC +/-15%)

Rated Voltage

1H (50Vdc)

Capacitance

680pF

Capacitance Tolerance

M (+/-20%)

Dissipation Factor

3% Max.

Insulation Resistance

10Gohm Min.

AEC-Q200

Yes

DC Bias Characteristic

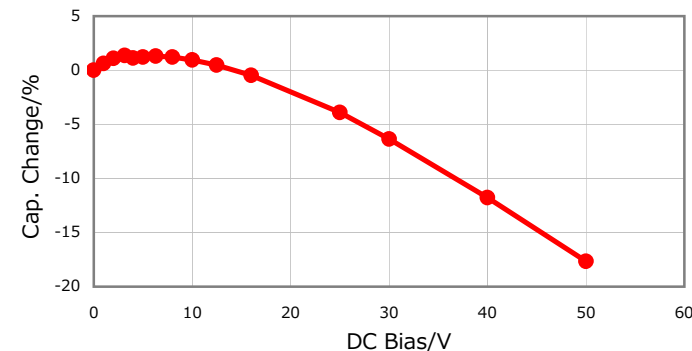

|Z|, ESR vs. Freq. Characteristics

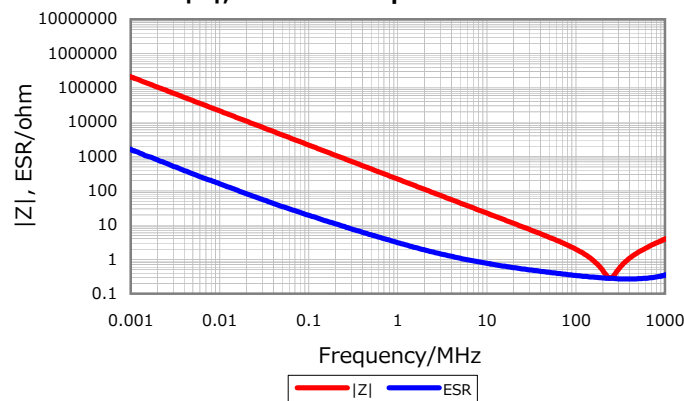

Temperature Characteristics

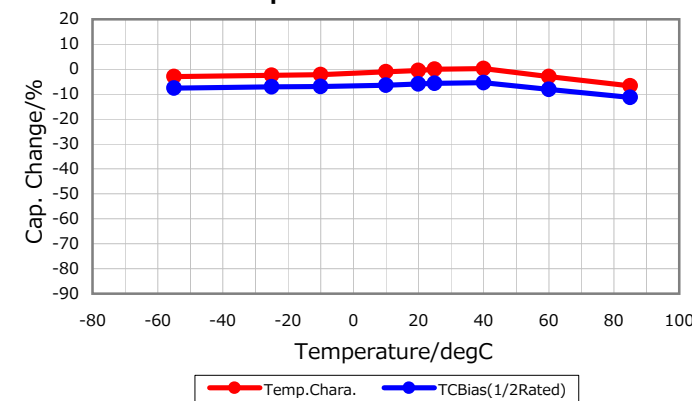

Cap. vs. Freq. Characteristic

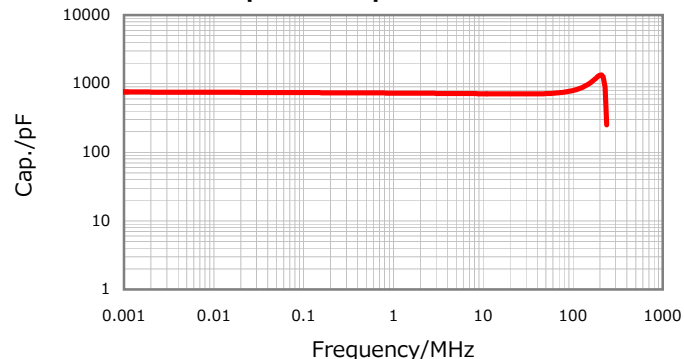

Ripple Temperature Rise Characteristics

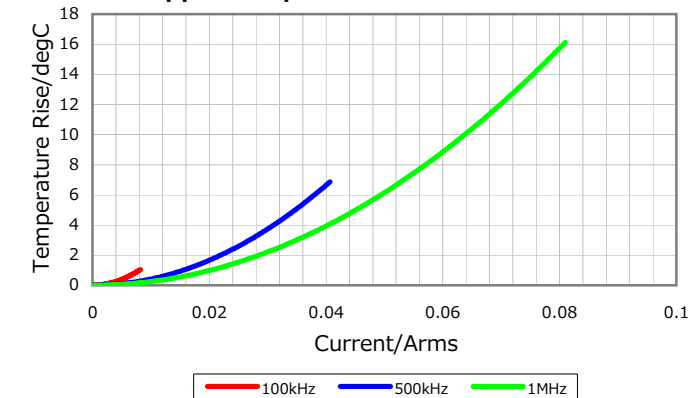

Characterization Sheet (Multilayer Ceramic Chip Capacitors)



All specifications are subject to change without notice.

January 4, 2016