

T502, Tantalum, MnO2 Tantalum, High Temperature, 6.8 uF, 20%, 35 VDC, SMD, MnO2, Un-Encapsulated, High Temperature, 230C, N/A, 1.8 Ohms, 7343, Height Max = 3.1mm

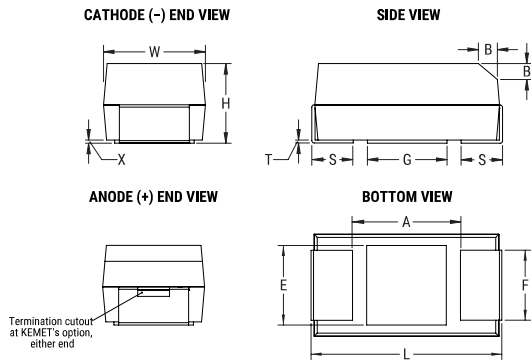

Dimensions	
Footprint	7343
L	7.3mm +/-0.3mm
W	4.3mm +/-0.3mm
H	2.8mm +/-0.3mm
T	0.13mm REF
S	1.3mm +/-0.3mm
F	2.4mm +/-0.1mm
A	3.6mm MIN
B	0.5mm +/-0.15mm
P	0.9mm REF
R	1mm REF
X	0.1mm +/-0.1mm

Packaging Specifications	
Packaging:	T&R, 178mm
Packaging Quantity:	500

General Information	
Supplier:	KEMET
Series:	T502
Dielectric:	MnO2 Tantalum
Style:	SMD Chip
Description:	SMD, MnO2, Un-Encapsulated, High Temperature, 230C
Features:	230C
RoHS:	Yes
Termination:	Gold
Notes:	In Polarity Stripe, At KEMET's Option, Type May Be Indicated: No Symbol = Standard (Or Low Leakage) MnO2 Tantalum Chip, O = LowESR T494, R = Low ESR T495, F = Fused T496, HT = 150C Rated T498 (or B45196P, B45198P), H = 175C rated T499, M = Multiple Anode
Shelf Life:	156 Weeks
MSL:	1

Specifications	
Capacitance:	6.8 uF
Capacitance Tolerance:	20%
Voltage DC:	35 VDC (85C), 28.7 VDC (125C), 11.6 VDC (230C)
Temperature Range:	-55/+230C
Rated Temperature:	85C
Dissipation Factor:	6.00% 120Hz 25C
Failure Rate:	N/A
Resistance:	1.8 Ohms (100kHz 25C)
Ripple Current:	289 mA (100kHz 45C)
Leakage Current:	2.4 uA (5min 25C)

Statements of suitability for certain applications are based on our knowledge of typical operating conditions for such applications, but are not intended to constitute - and we specifically disclaim - any warranty concerning suitability for a specific customer application or use. This Information is intended for use only by customers who have the requisite experience and capability to determine the correct products for their application. Any technical advice inferred from this Information or otherwise provided by us with reference to the use of our products is given gratis, and we assume no obligation or liability for the advice given or results obtained.