

# Power Relay G2A

CSM\_G2A\_DS\_E\_3\_1

## Highly Reliable, 4-pole Miniature Relay Ideal for Sequence Control

- Card lift-off employed for greater life and stable quality.
- Long endurance and stable quality are assured by card lift-off system.
- Mounting interchangeability with MY-series Relays.
- Operation indicator mechanism incorporated for at-a-glance monitoring of ON/OFF operation. In addition, a built-in operation indicator model is also included in this Relay Series.



## Ordering Information

| Classification                               | Plug-in terminals/Solder terminals | PCB terminals |
|--|------------------------------------|---------------|
| Standard model                               | G2A-432A                           | G2A-4321P     |
| Arc barrier equipped model                   | G2A-432AY                          | ---           |
| Built-in diode model                         | G2A-432A-D                         | G2A-4321P-D   |
| Built-in operation indicator model           | G2A-432A-N                         | ---           |
| Built-in operation indicator and diode model | G2A-432A-N1                        | ---           |

**Note:** 1. When placing your order, add the coil voltage rating listed in the specifications to the model number as shown below.

Example: G2A-432A 100/110 VAC  
Rated coil voltage

2. Built-in diode model and the operating coil of the G2A-432A-N1 are available only with DC ratings.

3. The Latching Relay (G2AK) and Fully sealed Relay (G2A-434A) developed based on the G2A are also available in this series.

## Model Number Legend

G2A-            -    
1 2 3 4 5 6

### 1. Number of Poles and Contact Form

4: 4PDT

### 2. Contact Type

3: Crossbar bifurcated

### 3. Enclosure Construction

2: Casing

### 4. Terminal Shape

A: Plug-in

1P: PCB

### 5. Safety Breaking Mechanism

None: No

Y: Arc barrier

### 6. Special Element

None: Standard

D: Built-in diode

N: Built-in operation indicator

N1: Built-in operation indicator and diode

**Note:** 1. The coil of the G2A-432A-N1 or a built-in diode model operates with DC only.

2. The G2A Series include the G2A-434A Power Relay and G2AK Latching Relay. Refer to G2A-434 and G2AK for details.

## ■ Relays Other than Standard Models

| Arc barrier equipped   | Built-in diode   | Built-in operation indicator   |
|--|--|--|
| G2A-432AY  | G2A-432A-D   | G2A-432A-N   |
| The arc barrier equipped model is a relay designed to prevent arc short-circuiting between phases and can be used in a circuit which has potential difference between phases. The switching power of such a circuit with potential difference must be limited to less than 1/2 the rated load when using this Relay. | The built-in diode model is a relay which incorporates a diode for absorption of the reverse voltage that may be generated when the coil is de-energized. Because the release time of this model is longer than the standard model, pay adequate attention to this point in designing a circuit. Also, pay attention to the + polarity of the coil. The reverse-breakdown voltage of the diode is 1,000 V. | The built-in operation indicator model has a newly added operation indicator to the conventional operation indication mechanism and facilitates operation monitoring without being affected by ambient illumination.<br>With the -N model (rated at 16, 12, 24, and 48 VDC) and -N1 model rated at 6, 12, 24, 48, and 100 VDC), pay attention to the + polarity of the coil. |

## ■ Accessories

### Sockets

| Track mounting<br>Screw terminals | Front-connecting<br>Socket   | Solder terminals        |                     | Wire-wrap terminals    |                     | PCB<br>terminals |
|-----------------------------------|------------------------------|-------------------------|---------------------|------------------------|---------------------|------------------|
|                                   |                              | Without Hold-down Clip  | With Hold-down Clip | Without Hold-down Clip | With Hold-down Clip |                  |
| PYF14A                            | PYF14(-E), PYF14A-TU, PYF14T | PY14, PY14-3 (see note) | PY14-Y2             | PY14QN(2)              | PY14QN(2)-Y2        | PY14-0, PY14-02  |

Note: With monitor terminal.

### Relay Hold-down Clips

|                             |             |
|-----------------------------|-------------|
| For Front-connecting Socket | PYC-A2      |
| For Back-connecting Socket  | PYC-3/PYC-5 |
| For Socket Mounting Plate   | PYC-2       |

### Socket Mounting Plates

|                |        |
|----------------|--------|
| For one Socket | PYP-1  |
| For 18 Sockets | PYP-18 |
| For 36 Sockets | PYP-38 |

## Specifications

### ■ Coil Ratings

The rated currents for some of the built-in operation indicator models differ from the values given in this table. Refer to note 5 below.

| Rated voltage   | Rated current    |                | Coil resistance | Coil inductance (ref. value) |             | Must operate | Must release | Max. voltage  | Power consumption |
|-----------------|------------------|----------------|-----------------|------------------------------|-------------|--------------|--------------|---------------|-------------------|
|                 | 50 Hz            | 60 Hz          |                 | Armature OFF                 | Armature ON |              |              |               |                   |
| 6 VAC           | 295 mA           | 233 mA         | 8.9 Ω           | 0.048 H                      | 0.065 H     | 80 % max.    | 30 % min.    | 110 %         | Approx. 1.4 VA    |
| 12 VAC          | 148 mA           | 117 mA         | 34 Ω            | 0.166 H                      | 0.257 H     |              |              |               |                   |
| 24 VAC          | 73 mA            | 58 mA          | 136 Ω           | 0.691 H                      | 1.04 H      |              |              |               |                   |
| 50 VAC          | 35 mA            | 28 mA          | 530 Ω           | 3.08 H                       | 4.53 H      |              |              |               |                   |
| 100/<br>110 VAC | 17.7/<br>21.4 mA | 14/<br>16.8 mA | 2,200 Ω         | 12.42/<br>12.38 H            | 18/16.4 H   |              |              |               |                   |
| 200/<br>220 VAC | 8.9/<br>10.8 mA  | 7/8.4 mA       | 8,800 Ω         | 42.2/<br>41.8 H              | 72/65.5 H   |              |              |               |                   |
| 6 VDC           | 176 mA           |                | 34 Ω            | 0.14 H                       | 0.26 H      | 10 % min.    | 110 %        | Approx. 1.1 W |                   |
| 12 VDC          | 88 mA            |                | 136 Ω           | 0.6 H                        | 1.0 H       |              |              |               |                   |
| 24 VDC          | 45 mA            |                | 530 Ω           | 2.7 H                        | 4.6 H       |              |              |               |                   |
| 48 VDC          | 22 mA            |                | 2,200 Ω         | 11 H                         | 19 H        |              |              |               |                   |
| 100 VDC         | 11.4 mA          |                | 8,800 Ω         | 43 H                         | 73 H        |              |              |               |                   |

Note: 1. The rated current and coil resistance are measured at a coil temperature of 23°C with tolerances of +15%/–20% for AC rated current and ±15% for DC coil resistance.

- The AC coil resistance and coil inductance values are for reference only.
- Performance characteristic data is measured at a coil temperature of 23°C.
- The maximum voltage is one that is applicable instantaneously to the Relay coil at an ambient temperature of 23°C and not continuously.
- For built-in operation indicator models rated at 6, 12, and 24 VDC, add an LED current of approx. 5 mA to the rated currents.

## ■ Contact Ratings

| Load                 | Resistive load ( $\cos\phi = 1$ )      | Inductive load ( $\cos\phi = 0.4$ ) (L/R = 7 ms) |
|----------------------|--|--|
| Contact type         | Crossbar bifurcated                    |  |
| Contact material     | Movable: AgAu-clad AgPd<br>Fixed: AgPd |  |
| Rated load           | 0.3 A at 110 VAC<br>0.5 A at 24 VDC    | 0.2 A at 110 VAC<br>0.3 A at 24 VDC              |
| Rated carry current  | 3 A                                    |  |
| Max. switching power | 250 VAC, 125 VDC                       |  |

## ■ Characteristics

| Classification                                      | Standard/Acr barrier equipped/Built-in operation indicator models (G2A-□-N)   | Built-in diode/Built-in operation indicator models (G2A-□-N1) |
|---|---|---|
| Contact resistance (see note 2)                     | 100 mΩ max.   |   |
| Operate time (see note 3)                           | 15 ms max.  |   |
| Release time (see note 3)                           | 15 ms max.  | 30 ms max.  |
| Max. operating frequency                            | Mechanical: 18,000 operations/hour<br>Electrical: 1,800 operations/hour (under rated load)  |   |
| Insulation resistance (see note 4)                  | 100 MΩ min. (at 500 VDC)  |   |
| Dielectric strength                                 | 1,500 VAC, 50/60 Hz for 1 min between coil and contacts and contacts of different polarities (700 VAC between contacts of same polarity)  |   |
| Vibration resistance                                | Destruction: 10 to 55 to 10 Hz, 0.75 mm single amplitude (1.5 mm double amplitude)<br>Malfunction: 10 to 55 to 10 Hz, 0.5 mm single amplitude (1.0 mm double amplitude)   |   |
| Shock resistance                                    | Destruction: 1,000 m/s <sup>2</sup><br>Malfunction: 100 m/s <sup>2</sup>  |   |
| Error rate (level P) (Reference value) (see note 6) | 1 mA at 100 mVDC  |   |
| Endurance   | Mechanical: 100,000,000 operations min. (at operating frequency of 18,000 operations/hour)<br>Electrical: 5,000,000 operations min. (under rated load and at operating frequency of 1,800 operations/hour) (see note 5) |   |
| Ambient temperature                                 | Operating: -10°C to 40°C (with no icing or condensation)  |   |
| Ambient humidity                                    | Operating: 5% to 85%  |   |
| Weight  | Approx. 38 g  |   |

**Note:** 1. The data shown above are initial values.

2. The contact resistance was measured with 0.1 A at 5 VDC using the voltage drop method.

3. The operate or release time was measured with the rated voltage imposed with any contact bounce ignored at an ambient temperature of 23°C.

4. The insulation resistance was measured with a 500-VDC megger applied to the same places as those used for checking the dielectric strength.

5. The electrical endurance was measured at an ambient temperature of 23°C.

6. This value was measured at a switching frequency of 60 operations per minute.

# Engineering Data

## Maximum Switching Power

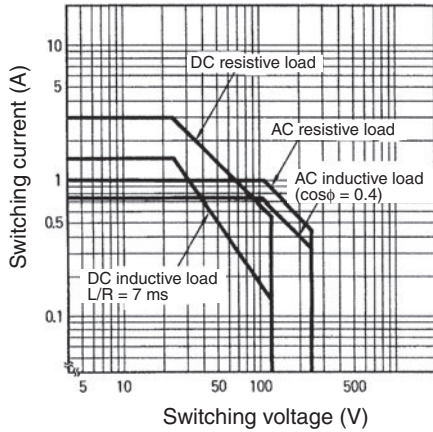

## Endurance

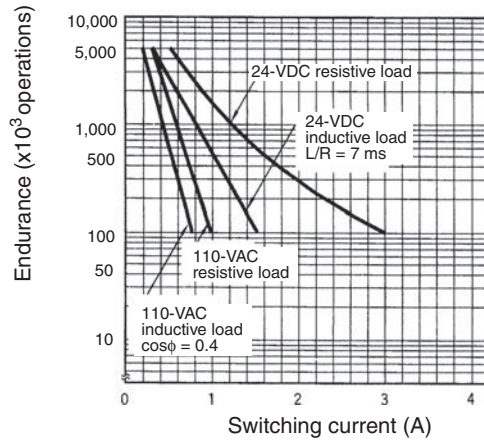

## Ambient Temperature vs. Must-operate and Must-release Voltage

G2A AC (60 Hz)

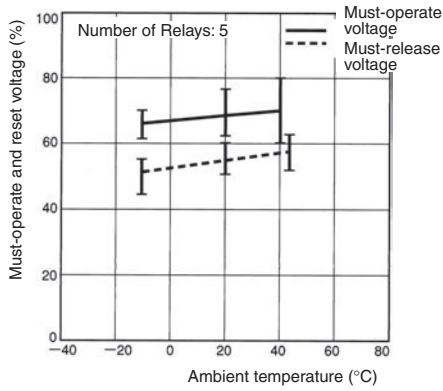

## Ambient Temperature vs. Coil Temperature Rise

G2A 110 VAC (50 Hz)

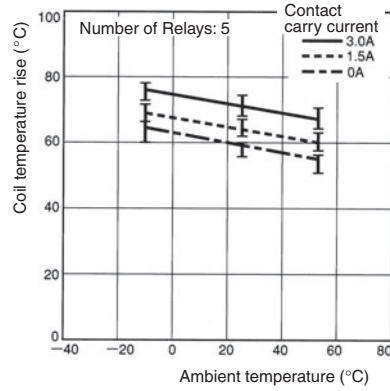

## Malfunctioning Shock

G2A-432A 100/110 VAC

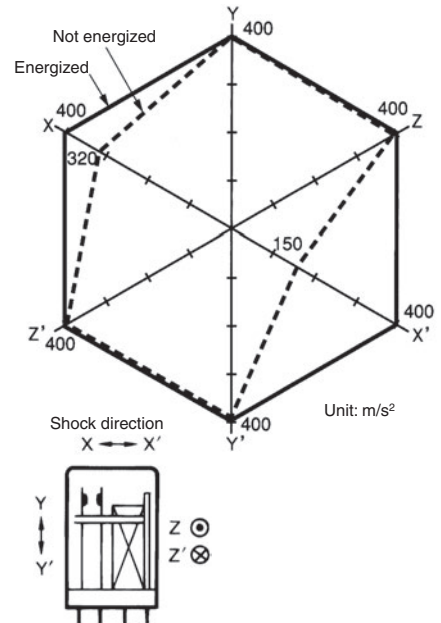

Number of samples = 5

Measurement conditions: Impose a shock of 100 m/s<sup>2</sup> in the ±X, ±Y, and ±Z directions three times each with the Relay energized and not energized to check the shock values that cause the Relay to malfunction.

G2A DC

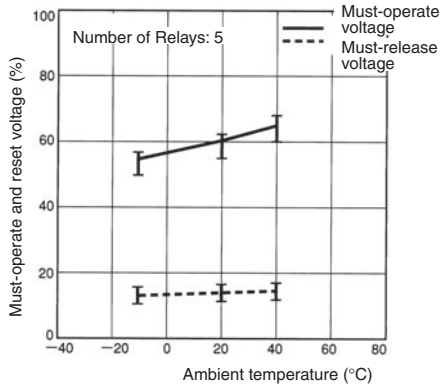

G2A DC

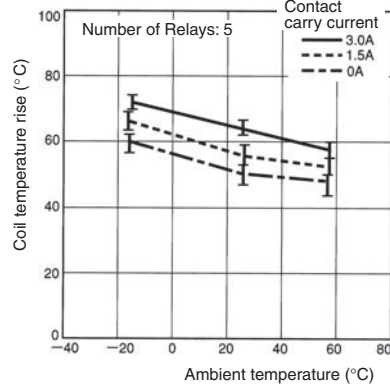

**Contact Reliability  
(JIS C 4530 Allen-Bradley Test Circuit)**

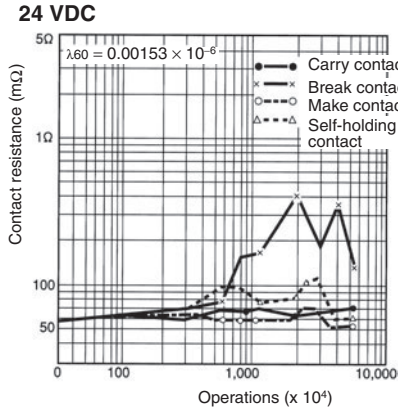
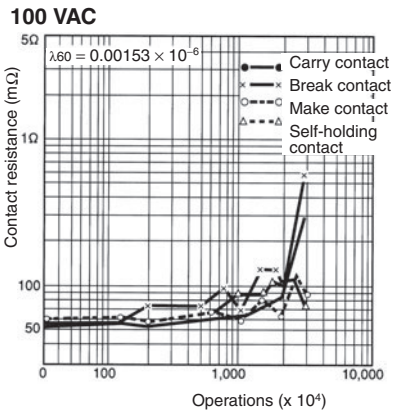

**Contact Reliability  
(Improved Allen-Bradley Test Circuit)**

Contact load: 1 mA at 5 VDC (resistive load)  
Failure criterion contact resistance: 100 Ω

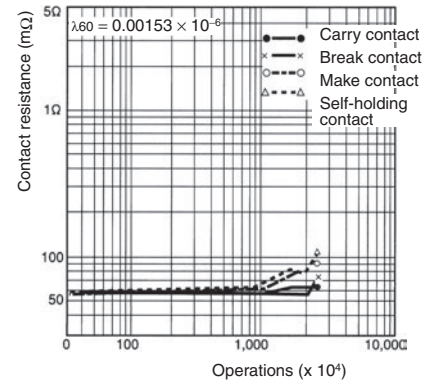

**Coil Self-load Life Curve**

(Unit: mA)

| Model    | Specifications | No. of Relays |    |     |     |     |
|----------|----------------|---------------|----|-----|-----|-----|
|          |                | 1             | 2  | 3   | 5   | 10  |
| G2A-432A | 100 VAC, 60 Hz | 14            | 28 | 42  | 70  | 140 |
|          | 24 VDC         | 45            | 90 | 135 | 225 | 450 |

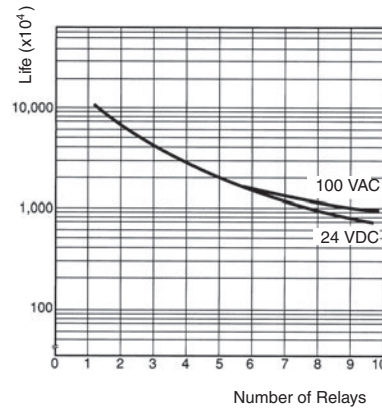

**Relay Mounting Adjacent Distance vs. Coil Temperature Rise  
G2A-432A 24 VDC**

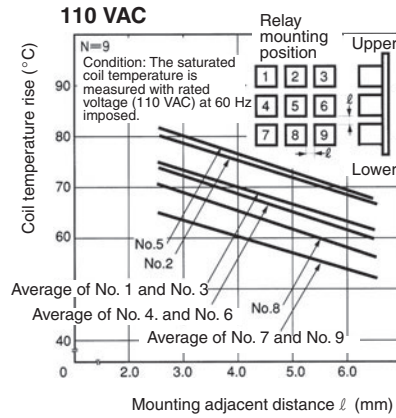
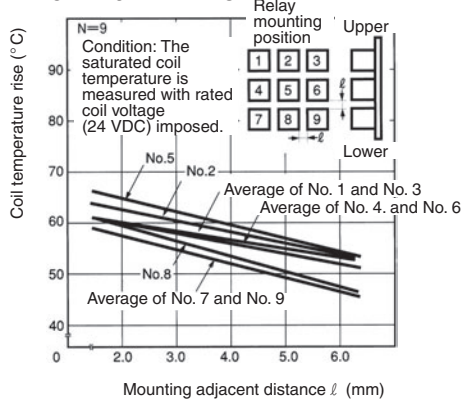



# Accessories (Order Separately)

## Connecting Sockets

| Front-connecting Socket           | Back-connecting Socket |  |                     |   |               |         |
|-----------------------------------|------------------------|--|---------------------|---|---------------|---------|
|                                   | Solder terminals       |  | Wire-wrap terminals |   | PCB terminals |         |
| DIN track/screw mounting          |                        |  |                     |   |               |         |
| PYF14A(-E)<br>PYF14A-TU<br>PYF14T | PY14<br>PY14-Y3        | PY14-Y2<br>(with Relay Hold-down Clip) | PY14QN(2)           | PY14QN(2)-Y2<br>(with Relay Hold-down Clip) | PY14-0        | PY14-02 |
|                                   |                        |  |                     |   |               |         |

- Note:**
1. The PYF□A-TU is a high-humidity relay with nickel-plated rustproof terminal screws that are the same as the PYF□A in size.
  2. The PYF14T is slightly different from the PYF14A(-TU) in shape and size.
  3. The PYF□A-E is a finger-protection model, for which round terminals are not available. Use fork-shaped terminals or equivalent ones instead.

### PY14-3 Back-connecting Socket (with check terminals for operation monitoring)

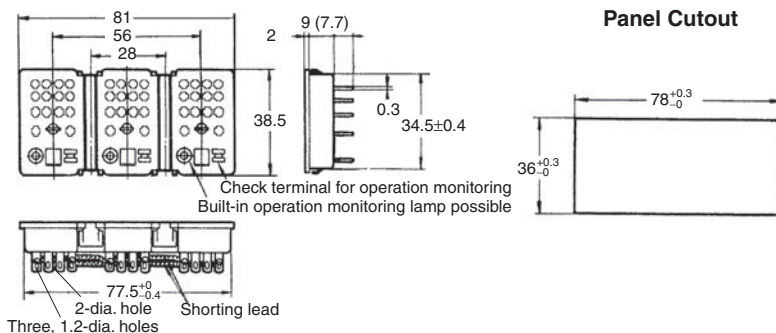
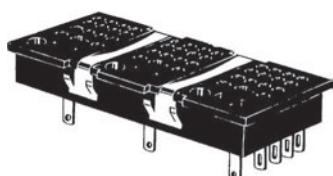

### Relay Mounting Height with Socket

With Front-connecting Socket

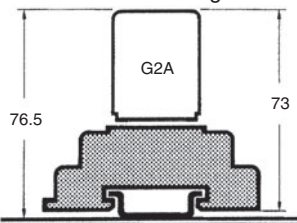

With Back-connecting Socket

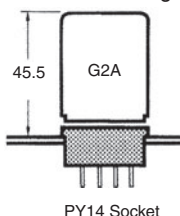

PYF14A

Note: PYF14A can be used for both DIN track mounting and screw mounting.

## Relay Hold-down Clips

| For Front-connecting Socket | For Back-connecting Socket |       | For Socket mounting plate |
|-----------------------------|----------------------------|-------|---------------------------|
| PYC-A2                      | PYC-3                      | PYC-5 | PYC-2                     |
|                             |                            |       |                           |

**Note:** When using a Relay Hold-down Clip for the built-in operation indicator model, use of the PYC-A2 or PYC-5, which allows easy viewing of the indicator, is recommended.

# Dimensions

**Note:** 1. All units are in millimeters unless otherwise indicated.  
 2. Dimensional tolerances are  $\pm 0.1$  mm.

## Solder Terminal Models

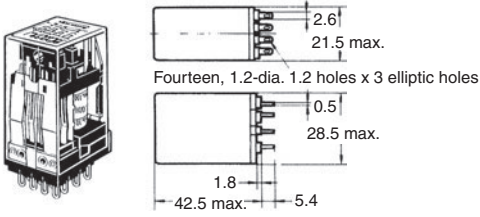

## PCB Terminal Models

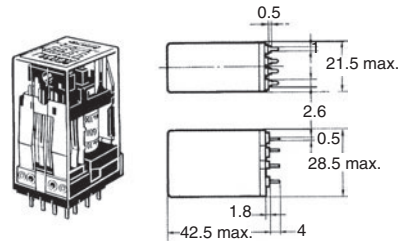

## Mounting Holes on PCB (Bottom View)

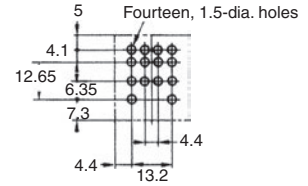

## Terminal Arrangement/Internal Connections (Bottom View)

### Standard Models

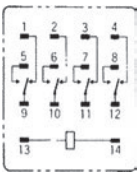

### Make-before-break Contact Models

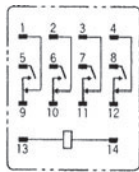

### Arc Barrier Equipped Models

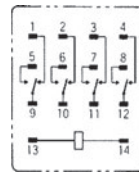

### Built-in Diode Models

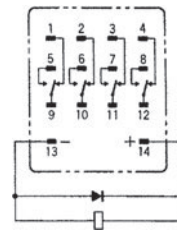

## Built-in Operation Indicator Models

Color of operation indicator  
 AC model: Red  
 DC model: Green

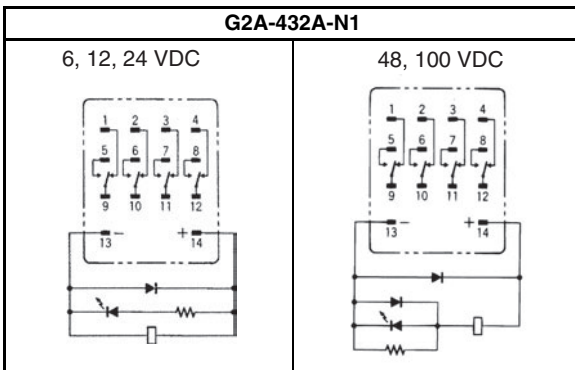
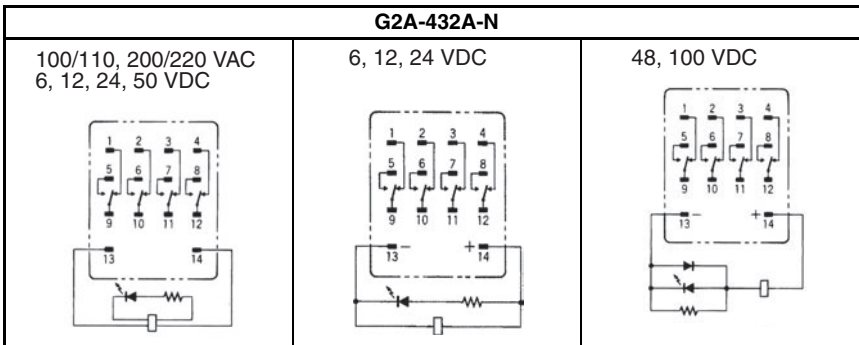

**Note:** Do not reverse the polarity of the coil of DC Relays that have a built-in indicator or diode.

## Socket Mounting Plates (t = 1.6 mm)

Use any of these plates when mounting two or more Sockets side-by-side

PYP-1 (for Single Socket Mounting)

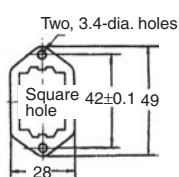

PYP-18 (for Mounting 18 Sockets)

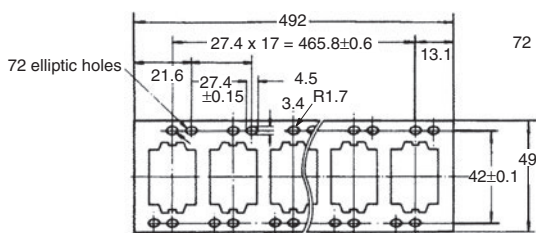

Note: PYP-18 and PYP-36 can be cut to a desired length for mounting less than 18 or 36 Sockets, respectively.

PYP-36 (for Mounting 36 Sockets)

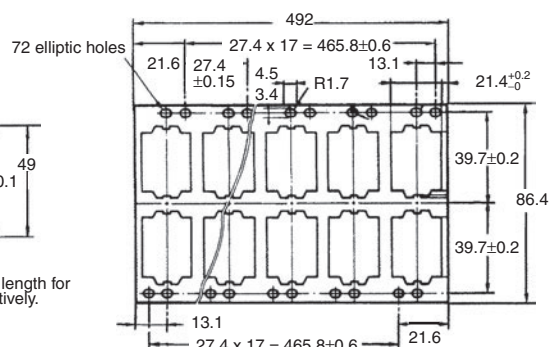

## Safety Precautions

Refer to *Safety Precautions for All Relays*.

A DC coil model with a built-in indicator or built-in diode has coil polarity. Be sure to wire the terminals correctly, otherwise the diode may be broken or the operating indicator may not be lit. Furthermore, as a result of the short-circuiting of the built-in diode, the devices in the circuit may be damaged.

ALL DIMENSIONS SHOWN ARE IN MILLIMETERS.

To convert millimeters into inches, multiply by 0.03937. To convert grams into ounces, multiply by 0.03527.

In the interest of product improvement, specifications are subject to change without notice.



## Read and Understand This Catalog

Please read and understand this catalog before purchasing the products. Please consult your OMRON representative if you have any questions or comments.

## Warranty and Limitations of Liability

### WARRANTY

OMRON's exclusive warranty is that the products are free from defects in materials and workmanship for a period of one year (or other period if specified) from date of sale by OMRON.

OMRON MAKES NO WARRANTY OR REPRESENTATION, EXPRESS OR IMPLIED, REGARDING NON-INFRINGEMENT, MERCHANTABILITY, OR FITNESS FOR PARTICULAR PURPOSE OF THE PRODUCTS. ANY BUYER OR USER ACKNOWLEDGES THAT THE BUYER OR USER ALONE HAS DETERMINED THAT THE PRODUCTS WILL SUITABLY MEET THE REQUIREMENTS OF THEIR INTENDED USE. OMRON DISCLAIMS ALL OTHER WARRANTIES, EXPRESS OR IMPLIED.

### LIMITATIONS OF LIABILITY

OMRON SHALL NOT BE RESPONSIBLE FOR SPECIAL, INDIRECT, OR CONSEQUENTIAL DAMAGES, LOSS OF PROFITS OR COMMERCIAL LOSS IN ANY WAY CONNECTED WITH THE PRODUCTS, WHETHER SUCH CLAIM IS BASED ON CONTRACT, WARRANTY, NEGLIGENCE, OR STRICT LIABILITY.

In no event shall the responsibility of OMRON for any act exceed the individual price of the product on which liability is asserted.

IN NO EVENT SHALL OMRON BE RESPONSIBLE FOR WARRANTY, REPAIR, OR OTHER CLAIMS REGARDING THE PRODUCTS UNLESS OMRON'S ANALYSIS CONFIRMS THAT THE PRODUCTS WERE PROPERLY HANDLED, STORED, INSTALLED, AND MAINTAINED AND NOT SUBJECT TO CONTAMINATION, ABUSE, MISUSE, OR INAPPROPRIATE MODIFICATION OR REPAIR.

## Application Considerations

### SUITABILITY FOR USE

OMRON shall not be responsible for conformity with any standards, codes, or regulations that apply to the combination of products in the customer's application or use of the products.

At the customer's request, OMRON will provide applicable third party certification documents identifying ratings and limitations of use that apply to the products. This information by itself is not sufficient for a complete determination of the suitability of the products in combination with the end product, machine, system, or other application or use.

The following are some examples of applications for which particular attention must be given. This is not intended to be an exhaustive list of all possible uses of the products, nor is it intended to imply that the uses listed may be suitable for the products:

- Outdoor use, uses involving potential chemical contamination or electrical interference, or conditions or uses not described in this catalog.
- Nuclear energy control systems, combustion systems, railroad systems, aviation systems, medical equipment, amusement machines, vehicles, safety equipment, and installations subject to separate industry or government regulations.
- Systems, machines, and equipment that could present a risk to life or property.

Please know and observe all prohibitions of use applicable to the products.

NEVER USE THE PRODUCTS FOR AN APPLICATION INVOLVING SERIOUS RISK TO LIFE OR PROPERTY WITHOUT ENSURING THAT THE SYSTEM AS A WHOLE HAS BEEN DESIGNED TO ADDRESS THE RISKS, AND THAT THE OMRON PRODUCTS ARE PROPERLY RATED AND INSTALLED FOR THE INTENDED USE WITHIN THE OVERALL EQUIPMENT OR SYSTEM.

### PROGRAMMABLE PRODUCTS

OMRON shall not be responsible for the user's programming of a programmable product, or any consequence thereof.

## Disclaimers

### CHANGE IN SPECIFICATIONS

Product specifications and accessories may be changed at any time based on improvements and other reasons.

It is our practice to change model numbers when published ratings or features are changed, or when significant construction changes are made. However, some specifications of the products may be changed without any notice. When in doubt, special model numbers may be assigned to fix or establish key specifications for your application on your request. Please consult with your OMRON representative at any time to confirm actual specifications of purchased products.

### DIMENSIONS AND WEIGHTS

Dimensions and weights are nominal and are not to be used for manufacturing purposes, even when tolerances are shown.

### PERFORMANCE DATA

Performance data given in this catalog is provided as a guide for the user in determining suitability and does not constitute a warranty. It may represent the result of OMRON's test conditions, and the users must correlate it to actual application requirements. Actual performance is subject to the OMRON Warranty and Limitations of Liability.

### ERRORS AND OMISSIONS

The information in this document has been carefully checked and is believed to be accurate; however, no responsibility is assumed for clerical, typographical, or proofreading errors, or omissions.

2010.8

In the interest of product improvement, specifications are subject to change without notice.

**OMRON Corporation**  
Industrial Automation Company

<http://www.ia.omron.com/>

(c)Copyright OMRON Corporation 2010 All Right Reserved.