

T502, Tantalum, MnO2 Tantalum, High Temperature, 10 uF, 20%, 16 VDC, SMD, MnO2, Un-Encapsulated, High Temperature, 230C, N/A, 2.8 Ohms, 3528, Height Max = 2.1mm

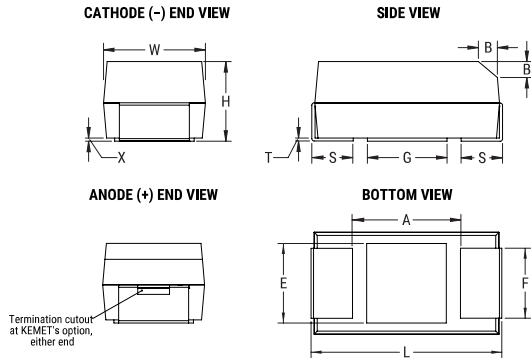

Dimensions	
Footprint	3528
L	3.5mm +/-0.2mm
W	2.8mm +/-0.2mm
H	1.9mm +/-0.2mm
T	0.13mm REF
S	0.8mm +0.1/-0.3mm
F	2.2mm +/-0.1mm
A	1.9mm MIN
B	0.4mm +/-0.15mm
P	0.5mm REF
R	1mm REF
X	0.1mm +/-0.1mm

Packaging Specifications	
Packaging:	T&R, 330mm
Packaging Quantity:	8000

General Information	
Supplier:	KEMET
Series:	T502
Dielectric:	MnO2 Tantalum
Style:	SMD Chip
Description:	SMD, MnO2, Un-Encapsulated, High Temperature, 230C
Features:	230C
RoHS:	Yes
Termination:	Gold
Notes:	In Polarity Stripe, At KEMET's Option, Type May Be Indicated: No Symbol = Standard (Or Low Leakage) MnO2 Tantalum Chip, O = LowESR T494, R = Low ESR T495, F = Fused T496, HT = 150C Rated T498 (or B45196P, B45198P), H = 175C rated T499, M = Multiple Anode
Shelf Life:	156 Weeks
MSL:	1

Specifications	
Capacitance:	10 uF
Capacitance Tolerance:	20%
Voltage DC:	16 VDC (85C), 13.1 VDC (125C), 5.3 VDC (230C)
Temperature Range:	-55/+230C
Rated Temperature:	85C
Dissipation Factor:	6.00% 120Hz 25C
Failure Rate:	N/A
Resistance:	2.8 Ohms (100kHz 25C)
Ripple Current:	174 mA (100kHz 45C)
Leakage Current:	1.6 uA (5min 25C)