

**Phase leg
SiC MOSFET Power Module**

$V_{DSS} = 1200V$
 $R_{DS(on)} = 12m\Omega \text{ max @ } T_j = 25^\circ C$
 $I_D = 220A^* \text{ @ } T_c = 25^\circ C$

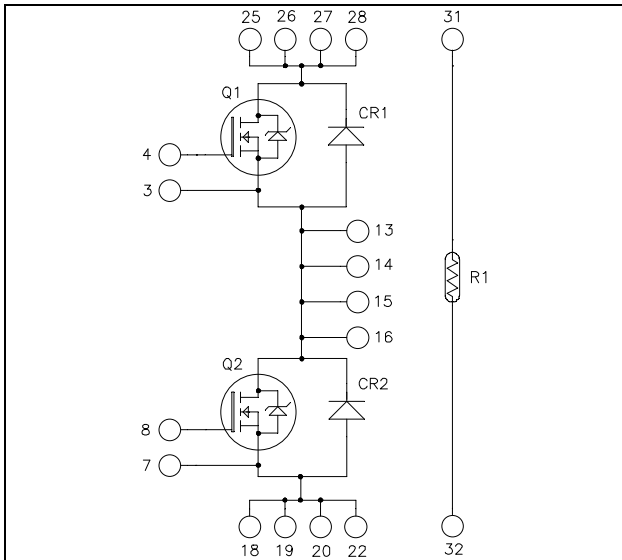

Application

- Welding converters
- Switched Mode Power Supplies
- Uninterruptible Power Supplies
- Motor control

Features

- **SiC Power MOSFET**
 - High speed switching
 - Low $R_{DS(on)}$
 - Ultra low loss
- **SiC Schottky Diode**
 - Zero reverse recovery
 - Zero forward recovery
 - Temperature Independent switching behavior
 - Positive temperature coefficient on VF

- Very low stray inductance
- Kelvin source for easy drive
- Internal thermistor for temperature monitoring
- High level of integration
- AlN substrate for improved thermal performance

Benefits

- Outstanding performance at high frequency operation
- Direct mounting to heatsink (isolated package)
- Low junction to case thermal resistance
- Solderable terminals both for power and signal for easy PCB mounting
- Low profile
- RoHS Compliant

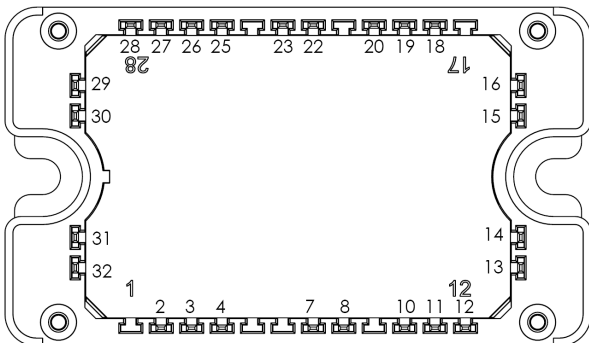

Pins 25 to 28 must be shorted together
Pins 13 to 16 must be shorted together
Pins 18/19/20/22 must be shorted together

All ratings @ $T_j = 25^\circ C$ unless otherwise specified

CAUTION: These Devices are sensitive to Electrostatic Discharge. Proper Handling Procedures Should Be Followed.
See application note APT0502 on www.microsemi.com

Absolute maximum ratings (per SiC MOSFET)

<i>Symbol</i>	<i>Parameter</i>	<i>Max ratings</i>	<i>Unit</i>
V _{DSS}	Drain - Source Voltage	1200	V
I _D	Continuous Drain Current	T _c = 25°C	220*
		T _c = 80°C	165*
I _{DM}	Pulsed Drain current	440	A
V _{GS}	Gate - Source Voltage	-10/25V	V
R _{DS(on)}	Drain - Source ON Resistance	12	mΩ
P _D	Maximum Power Dissipation	T _c = 25°C	925
			W

* Specification of device but current must be limited due to size of pins.

Electrical Characteristics (per SiC MOSFET)

<i>Symbol</i>	<i>Characteristic</i>	<i>Test Conditions</i>	<i>Min</i>	<i>Typ</i>	<i>Max</i>	<i>Unit</i>
I _{DSS}	Zero Gate Voltage Drain Current	V _{GS} = 0V, V _{DS} = 1200V			300	μA
R _{DS(on)}	Drain - Source on Resistance	V _{GS} = 20V I _D = 150A	T _j = 25°C	8	12	mΩ
			T _j = 150°C	14	21	
V _{GS(th)}	Gate Threshold Voltage	V _{GS} = V _{DS} ; I _D = 30mA	2.1	2.4		V
I _{GSS}	Gate - Source Leakage Current	V _{GS} = 20 V, V _{DS} = 0V			1.8	μA

Dynamic Characteristics (per SiC MOSFET)

<i>Symbol</i>	<i>Characteristic</i>	<i>Test Conditions</i>	<i>Min</i>	<i>Typ</i>	<i>Max</i>	<i>Unit</i>
C _{iss}	Input Capacitance	V _{GS} = 0V		8.4		nF
C _{oss}	Output Capacitance	V _{DS} = 1000V		0.66		
C _{rss}	Reverse Transfer Capacitance	f = 1MHz		0.045		
Q _g	Total gate Charge	V _{GS} = -5/+20V V _{Bus} = 800V I _D = 150A		483		nC
Q _{gs}	Gate - Source Charge			138		
Q _{gd}	Gate - Drain Charge			150		
T _{d(on)}	Turn-on Delay Time	V _{GS} = -5/+20V V _{Bus} = 800V I _D = 150A, T _j = 150°C R _L = 5.3Ω ; R _{Gext} = 6.7Ω		35		ns
T _r	Rise Time			40		
T _{d(off)}	Turn-off Delay Time			150		
T _f	Fall Time			70		
E _{on}	Turn on Energy	Inductive Switching V _{GS} = -5/+20V V _{Bus} = 600V I _D = 150A R _{Gext} = 6.7Ω	T _j = 150°C	3.3		mJ
E _{off}	Turn off Energy			T _j = 150°C	1.8	
R _{Gint}	Internal gate resistance			2		Ω
R _{thJC}	Junction to Case Thermal Resistance				0.135	°C/W

Body diode ratings and characteristics (per SiC MOSFET)

<i>Symbol</i>	<i>Characteristic</i>	<i>Test Conditions</i>	<i>Min</i>	<i>Typ</i>	<i>Max</i>	<i>Unit</i>
V _{SD}	Diode Forward Voltage	V _{GS} = -5V, I _{SD} = 75A		3.3		V
		V _{GS} = -2V, I _{SD} = 75A		3.1		
t _{rr}	Reverse Recovery Time	I _{SD} = 150A ; V _{GS} = -5V V _R = 800V ; di _f /dt = 3000A/μs		45		ns
Q _{rr}	Reverse Recovery Charge			1.2		μC
I _{rr}	Reverse Recovery Current			40		A



SiC schottky diode ratings and characteristics (per SiC diode)

Symbol	Characteristic	Test Conditions	Min	Typ	Max	Unit
V _{RRM}	Peak Repetitive Reverse Voltage				1200	V
I _{RRM}	Reverse Leakage Current	V _R =1200V	T _j = 25°C	105	600	μA
			T _j = 175°C	195	1200	
I _F	DC Forward Current		T _C = 125°C	60		A
V _F	Diode Forward Voltage	I _F = 60A	T _j = 25°C	1.5	1.8	V
			T _j = 175°C	2.2	3	
Q _C	Total Capacitive Charge	I _F = 60A, V _R = 1200V di/dt = 1500A/μs		390		nC
C	Total Capacitance	f = 1MHz, V _R = 400V		279		pF
		f = 1MHz, V _R = 800V		201		
R _{thJC}	Junction to Case Thermal Resistance				0.37	°C/W

Temperature sensor NTC (see application note APT0406 on www.microsemi.com).

Symbol	Characteristic	Min	Typ	Max	Unit
R ₂₅	Resistance @ 25°C		50		kΩ
ΔR ₂₅ /R ₂₅			5		%
B _{25/85}	T ₂₅ = 298.15 K		3952		K
ΔB/B		T _C =100°C	4		%

$$R_T = \frac{R_{25}}{\exp\left[B_{25/85}\left(\frac{1}{T_{25}} - \frac{1}{T}\right)\right]}$$

T: Thermistor temperature
R_T: Thermistor value at T

Thermal and package characteristics

Symbol	Characteristic	Min	Max	Unit		
V _{ISOL}	RMS Isolation Voltage, any terminal to case t=1 min, 50/60Hz	4000		V		
T _J	Operating junction temperature range	SiC MOSFET	-40	150	°C	
		SiC diode	-40	175		
T _{JOP}	Recommended junction temperature under switching conditions	-40	T _{J,max} -25			
T _{STG}	Storage Temperature Range	-40	125			
T _C	Operating Case Temperature	-40	100			
Torque	Mounting torque	To heatsink	M4	2	3	N.m
Wt	Package Weight				110	g

Package outline (dimensions in mm)

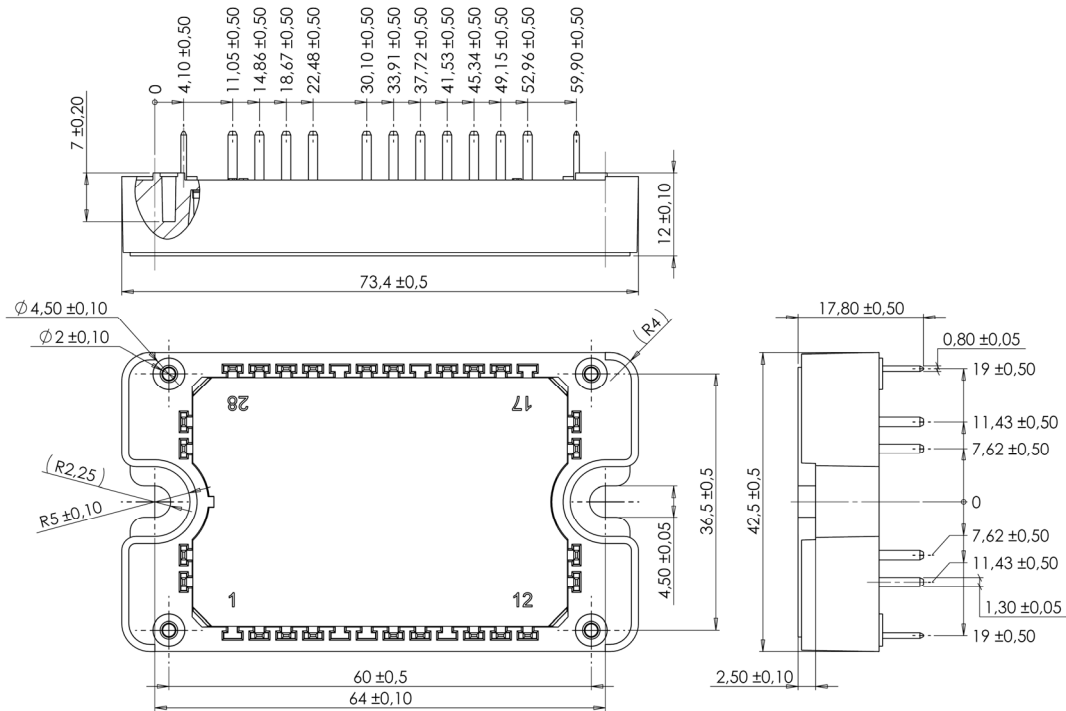

See application note 1906 - Mounting Instructions for SP3F Power Modules on www.microsemi.com

Typical SiC MOSFET Performance Curve

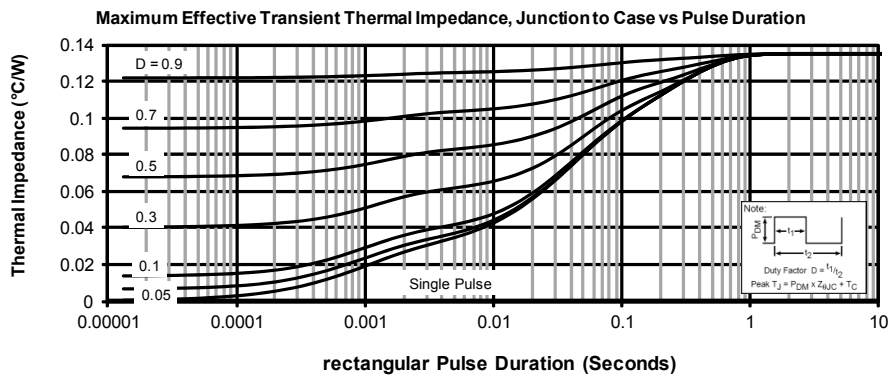
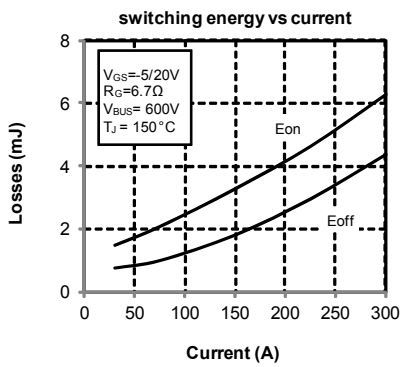
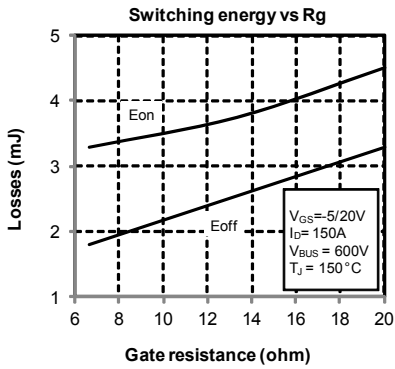
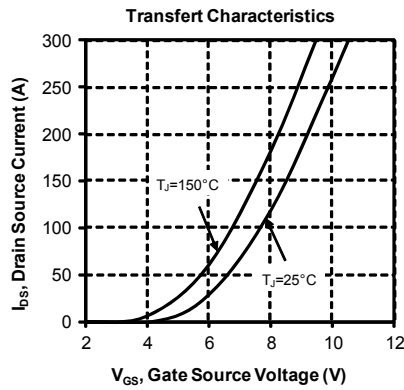
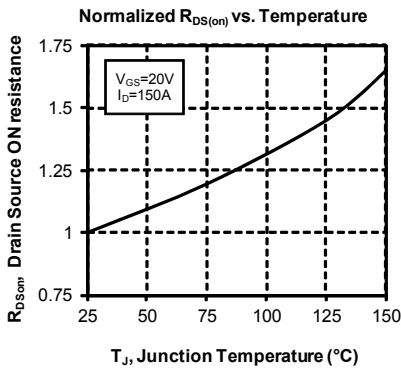
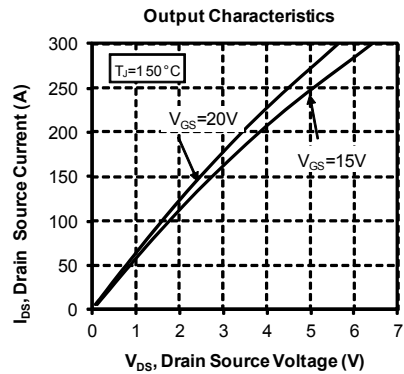
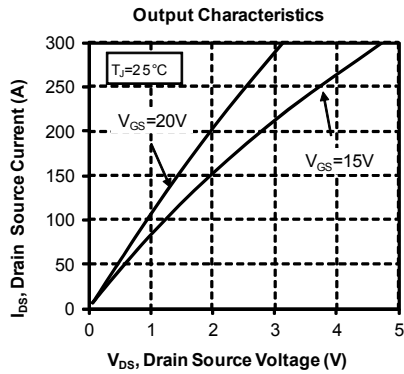

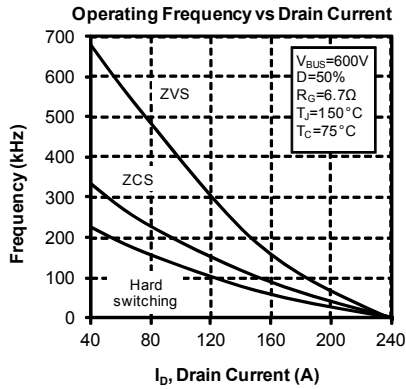
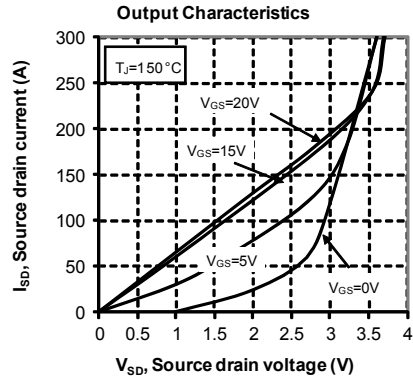
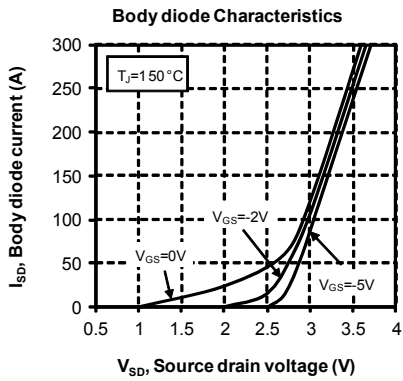
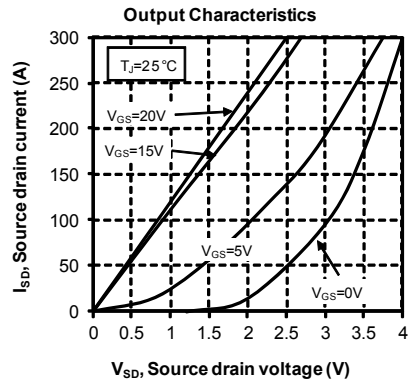
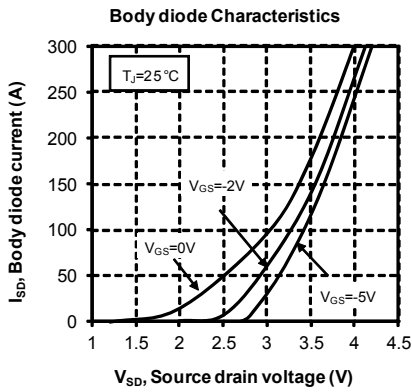
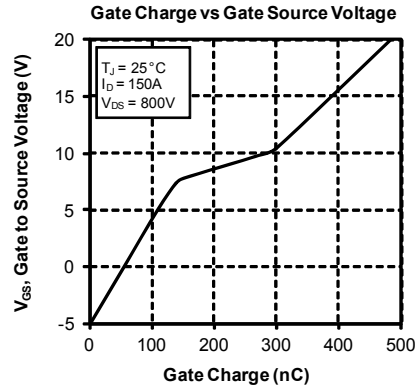
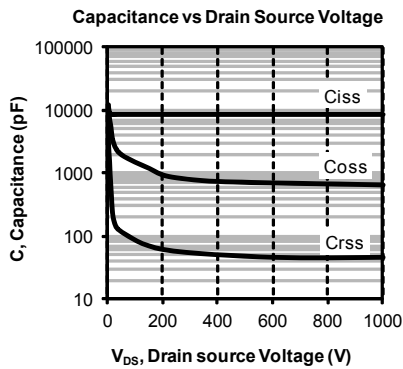

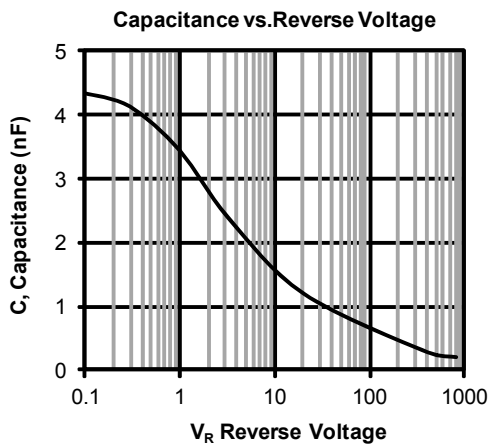
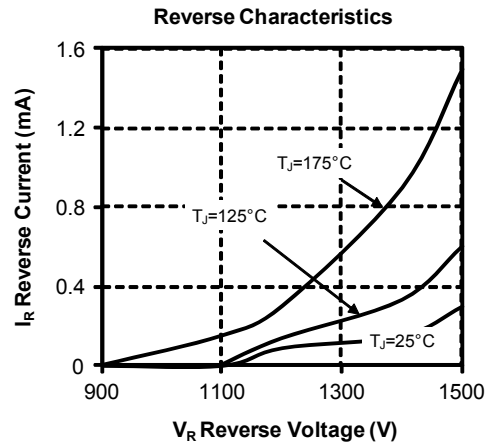
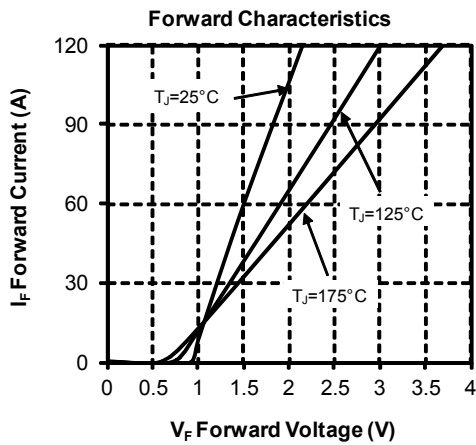
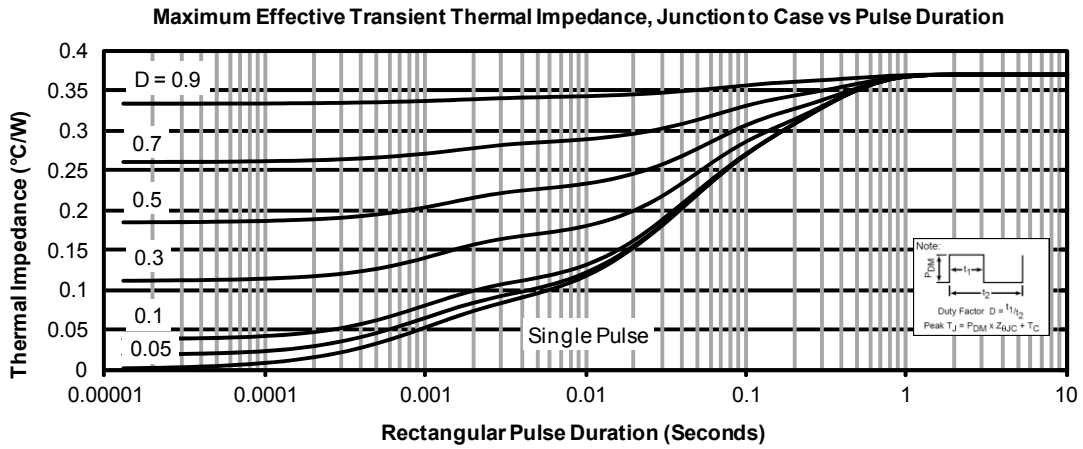
Typical SiC diode Performance Curve



DISCLAIMER

The information contained in the document (unless it is publicly available on the Web without access restrictions) is PROPRIETARY AND CONFIDENTIAL information of Microsemi and cannot be copied, published, uploaded, posted, transmitted, distributed or disclosed or used without the express duly signed written consent of Microsemi. If the recipient of this document has entered into a disclosure agreement with Microsemi, then the terms of such Agreement will also apply. This document and the information contained herein may not be modified, by any person other than authorized personnel of Microsemi. No license under any patent, copyright, trade secret or other intellectual property right is granted to or conferred upon you by disclosure or delivery of the information, either expressly, by implication, inducement, estoppels or otherwise. Any license under such intellectual property rights must be approved by Microsemi in writing signed by an officer of Microsemi.

Microsemi reserves the right to change the configuration, functionality and performance of its products at anytime without any notice. This product has been subject to limited testing and should not be used in conjunction with life-support or other mission-critical equipment or applications. Microsemi assumes no liability whatsoever, and Microsemi disclaims any express or implied warranty, relating to sale and/or use of Microsemi products including liability or warranties relating to fitness for a particular purpose, merchantability, or infringement of any patent, copyright or other intellectual property right. Any performance specifications believed to be reliable but are not verified and customer or user must conduct and complete all performance and other testing of this product as well as any user or customers final application. User or customer shall not rely on any data and performance specifications or parameters provided by Microsemi. It is the customer's and user's responsibility to independently determine suitability of any Microsemi product and to test and verify the same. The information contained herein is provided "AS IS, WHERE IS" and with all faults, and the entire risk associated with such information is entirely with the User. Microsemi specifically disclaims any liability of any kind including for consequential, incidental and punitive damages as well as lost profit. The product is subject to other terms and conditions which can be located on the web at <http://www.microsemi.com/legal/tnc.asp>

Life Support Application

Seller's Products are not designed, intended, or authorized for use as components in systems intended for space, aviation, surgical implant into the body, in other applications intended to support or sustain life, or for any other application in which the failure of the Seller's Product could create a situation where personal injury, death or property damage or loss may occur (collectively "Life Support Applications").

Buyer agrees not to use Products in any Life Support Applications and to the extent it does it shall conduct extensive testing of the Product in such applications and further agrees to indemnify and hold Seller, and its officers, employees, subsidiaries, affiliates, agents, sales representatives and distributors harmless against all claims, costs, damages and expenses, and attorneys' fees and costs arising, directly or indirectly, out of any claims of personal injury, death, damage or otherwise associated with the use of the goods in Life Support Applications, even if such claim includes allegations that Seller was negligent regarding the design or manufacture of the goods.

Buyer must notify Seller in writing before using Seller's Products in Life Support Applications. Seller will study with Buyer alternative solutions to meet Buyer application specification based on Sellers sales conditions applicable for the new proposed specific part.