

### Delphi Series E36SC050, Eighth Brick Family

#### DC/DC Power Modules:

#### 18~75V in, 5.0V/25A out, 125W

The Delphi Series E36SC050, Eighth Brick, 18V~75Vin input, single output, isolated DC/DC converters, are the latest offering from a world leader in power systems technology and manufacturing — Delta Electronics, Inc. This product family provides up to 125 watts of power or 25A of output current. With creative design technology and optimization of component placement, these converters possess outstanding electrical and thermal performance, as well as extremely high reliability under highly stressful operating conditions. Typical efficiency of the 5V/25A module is greater than 91%.

### FEATURES

- High efficiency: 91% @ 5V/25A
- Size:
  - 58.4x22.8x11.0mm (2.30"x0.90"x0.43") w/o heat-spreader
  - 58.4x22.8x12.7mm (2.30"x0.90"x0.50") with heat-spreader
- Industry standard footprint and pinout
- Fixed frequency operation
- SMD and through-hole versions
- Input UVLO
- OTP and output OVP
- Output OCP hiccup mode
- Output voltage trim down : -20%
- Output voltage trim up: +10% at Vin>20V
- Monotonic startup into normal and pre-biased loads
- 1500V isolation and basic insulation
- No minimum load required
- No negative current during power or enable on/off
- ISO 9001, TL 9000, ISO 14001, QS 9000,
- OHSAS18001 certified manufacturing facility
- UL/cUL 60950-1 (US & Canada) recognized

### OPTIONS

- Negative or Positive remote On/Off
- Surface-mount/Through-hole
- Open frame/Heat spreader

### APPLICATIONS

- Optical Transport
- Data Networking
- Communications
- Servers

# TECHNICAL SPECIFICATIONS

PARAMETER	NOTES and CONDITIONS	E36SC05025 (Standard)			
		Min.	Typ.	Max.	Units
<b>ABSOLUTE MAXIMUM RATINGS</b>					
<b>Input Voltage</b>					Vdc
Continuous		0		80	Vdc
Transient (100ms)	100ms			100	Vdc
Operating Ambient Temperature		-40		85	°C
Storage Temperature		-55		125	°C
Input/Output Isolation Voltage				1500	Vdc
<b>INPUT CHARACTERISTICS</b>					
Operating Input Voltage		18	48	75	Vdc
Input Under-Voltage Lockout					
Turn-On Voltage Threshold		16.5	17.2	17.9	Vdc
Turn-Off Voltage Threshold		15.5	16.2	16.9	Vdc
Lockout Hysteresis Voltage		0.3	1.0	1.8	Vdc
Maximum Input Current	Full Load, 18Vin			8.9	A
No-Load Input Current	Vin=48V, Io=0A		55		mA
Off Converter Input Current	Vin=48V, Io=0A		5		mA
Inrush Current (I <sub>rt</sub> )				1	A <sup>2</sup> s
Input Reflected-Ripple Current	P-P thru 12μH inductor, 5Hz to 20MHz		20		mA
Input Voltage Ripple Rejection	120 Hz		50		dB
<b>OUTPUT CHARACTERISTICS</b>					
Output Voltage Set Point	Vin=48V, Io=Io,max, Tc=25°C	4.925	5	5.075	Vdc
Output Regulation					
Over Load	Io=Io, min to Io, max			±5	mV
Over Line	Vin=18V to 75V			±5	mV
Over Temperature	Tc=-40°C to 85°C			±50	mV
Total Output Voltage Range	Over sample load, line and temperature	4.85	5	5.15	V
Output Voltage Ripple and Noise	5Hz to 20MHz bandwidth				
Peak-to-Peak	Vin=48V, Full Load, 1μF ceramic, 10μF tantalum		70		mV
RMS	Vin=48V, Full Load, 1μF ceramic, 10μF tantalum		23		mV
Operating Output Current Range	Vin=18V to 75V	0		25	A
Output Over Current Protection(hiccup mode)	Output Voltage 10% Low	27.5		35	A
<b>DYNAMIC CHARACTERISTICS</b>					
Output Voltage Current Transient	48Vin, 10μF Tan & 1μF Ceramic load cap, 0.1A/μs				
Positive Step Change in Output Current	75% Io,max to 50% Io,max		200		mV
Negative Step Change in Output Current	50% Io,max to 75% Io,max		200		mV
Settling Time (within 1% Vout nominal)			200		μs
Turn-On Transient					
Start-Up Time, From On/Off Control			55		mS
Start-Up Time, From Input			55		mS
Output Capacitance (note1)	Full load; 5% overshoot of Vout at startup			10000	μF
<b>EFFICIENCY</b>					
100% Load	Vin=24V		90.5		%
100% Load	Vin=48V		91		%
60% Load	Vin=48V		91.5		%
<b>ISOLATION CHARACTERISTICS</b>					
Input to Output				1500	Vdc
Isolation Resistance		10			MΩ
Isolation Capacitance			1000		pF
<b>FEATURE CHARACTERISTICS</b>					
Switching Frequency			300		KHz
ON/OFF Control, Negative Remote On/Off logic					
Logic Low (Module On)	Von/off			0.8	V
Logic High (Module Off)	Von/off	3.0		5	V
ON/OFF Control, Positive Remote On/Off logic					
Logic Low (Module Off)	Von/off			0.8	V
Logic High (Module On)	Von/off	3.0		5	V
ON/OFF Current (for both remote on/off logic)	Ion/off at Von/off=0.0V				mA
Leakage Current (for both remote on/off logic)	Logic High, Von/off=5V				
Output Voltage Trim Range(note 2)	Pout ≤ max rated power, Io ≤ Io,max	-20		10	%
Output Voltage Remote Sense Range	Pout ≤ max rated power, Io ≤ Io,max			10	%
Output Over-Voltage Protection	Over full temp range; % of nominal Vout	115		140	%
<b>GENERAL SPECIFICATIONS</b>					
MTBF	Io=80% of Io, max; Ta=25°C, airflow rate=300LFM		7.3		Mhours
Weight	Without heat spreader		24.6		grams
Weight	With heat spreader		33.2		grams
Over-Temperature Shutdown (Without heat spreader)	Refer to Figure 18 for Hot spot 1 location (48Vin, 80% Io, 200LFM, Airflow from Vin+ to Vin-)		132		°C
Over-Temperature Shutdown (With heat spreader)	Refer to Figure 21 for Hot spot 2 location (48Vin, 80% Io, 200LFM, Airflow from Vin+ to Vin-)		120		°C
Over-Temperature Shutdown (NTC resistor)	Refer to Figure 18 for NTC resistor location		130		°C

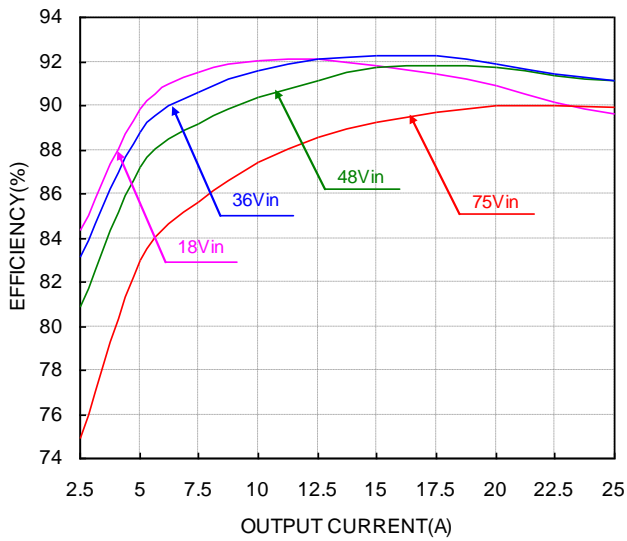
Note: Please attach thermocouple on NTC resistor to test OTP function, the hot spots' temperature is just for reference.

(TA=25°C, airflow rate=100 LFM, Vin=48Vdc, nominal Vout unless otherwise noted.)

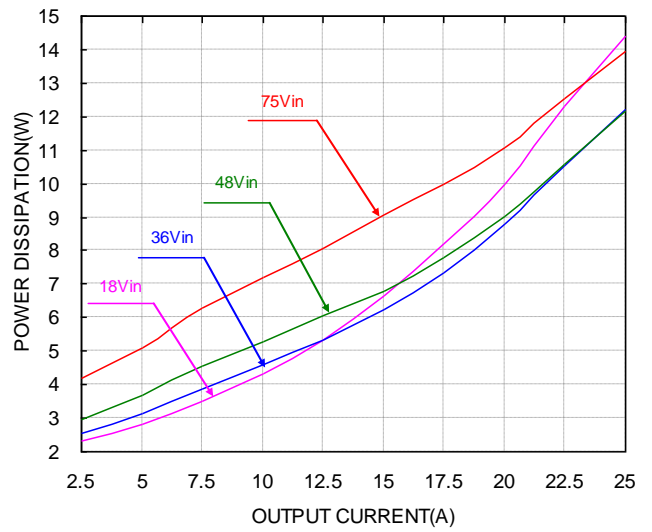
Note1: For applications with higher output capacitive load, please contact Delta.

Note2: Trim down range -20% for 18Vin ~75Vin, Trim up range +10% for 20Vin ~ 75Vin.

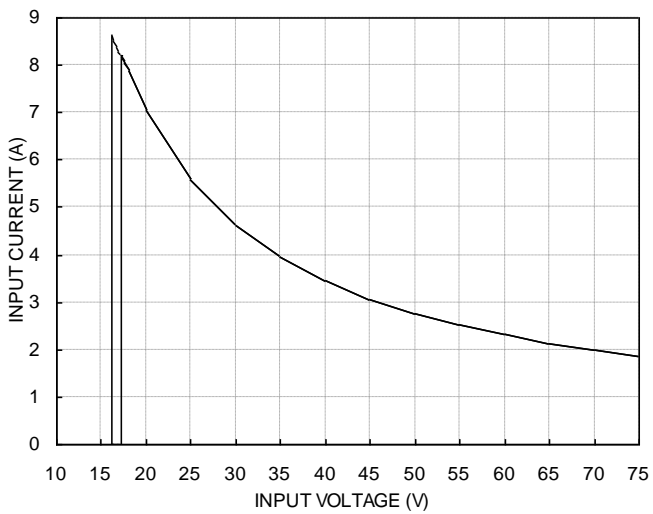
## ELECTRICAL CHARACTERISTICS CURVES



**Figure 1:** Efficiency vs. load current for 18V, 36V, 48V, and 75V input voltage at 25°C.



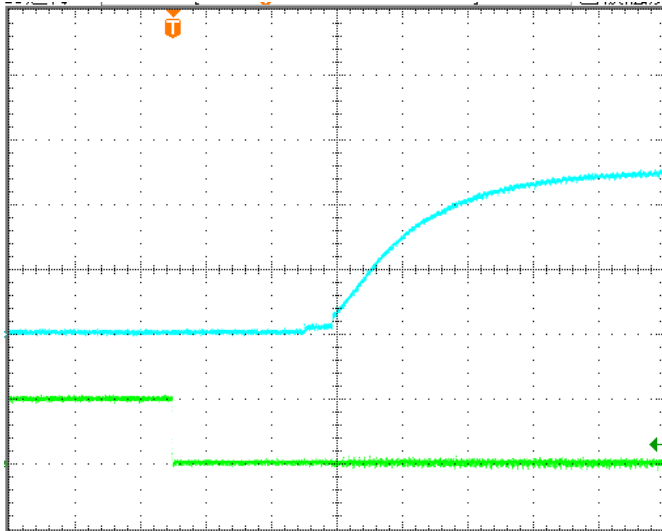
**Figure 2:** Power dissipation vs. load current for 18V, 36V, 48V, and 75V input voltage at 25°C.



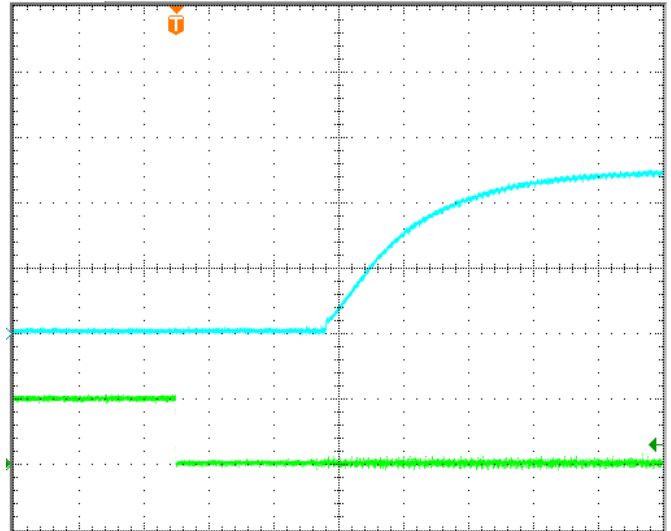
**Figure 3:** Full load input characteristics at room temperature.

## ELECTRICAL CHARACTERISTICS CURVES

### For Negative Remote On/Off Logic

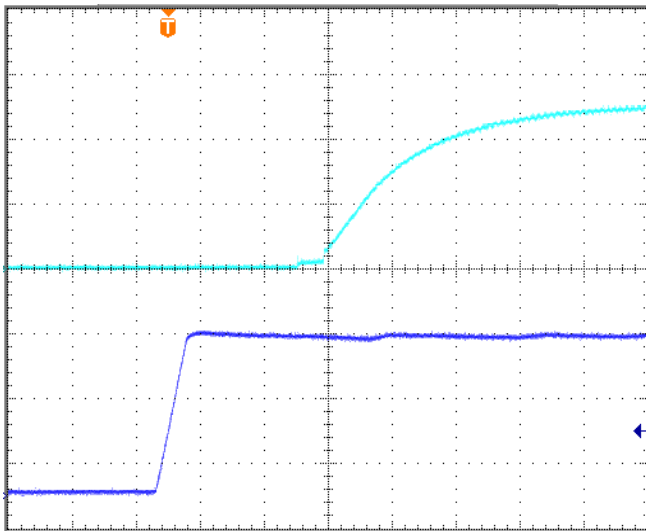


**Figure 4:** Turn-on transient at zero load current (10ms/div).  
 $V_{in}=48V$ . Top Trace:  $V_{out}$ ; 2V/div; Bottom Trace: ON/OFF input: 5V/div.

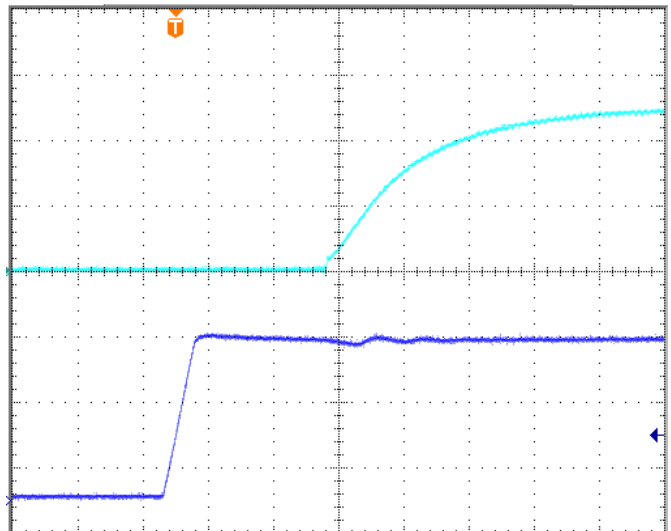


**Figure 5:** Turn-on transient at full load current (10ms/div).  
 $V_{in}=48V$ . Top Trace:  $V_{out}$ ; 2V/div; Bottom Trace: ON/OFF input: 5V/div.

### For Input Voltage Start up

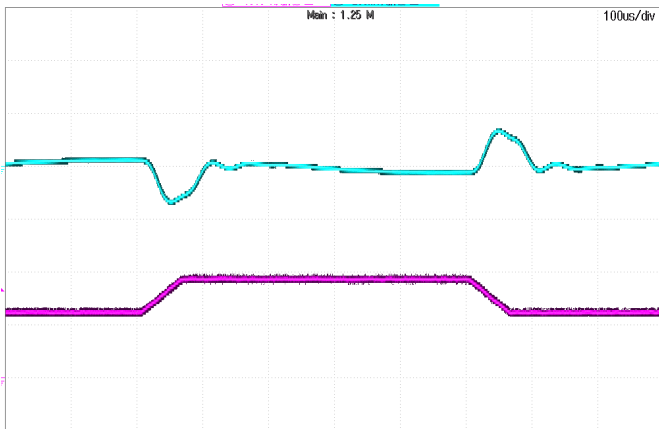


**Figure 6:** Turn-on transient at zero load current (10 ms/div).  
 Top Trace:  $V_{out}$ ; 2V/div; Bottom Trace: input voltage: 20V/div.

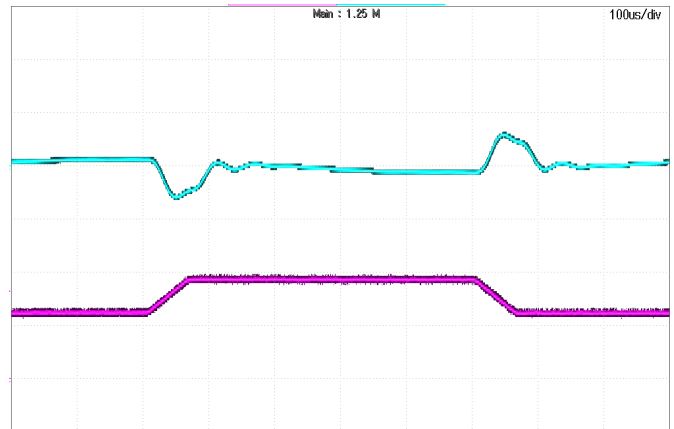


**Figure 7:** Turn-on transient at full load current (10 ms/div).  
 Top Trace:  $V_{out}$ ; 2V/div; Bottom Trace: input voltage: 20V/div.

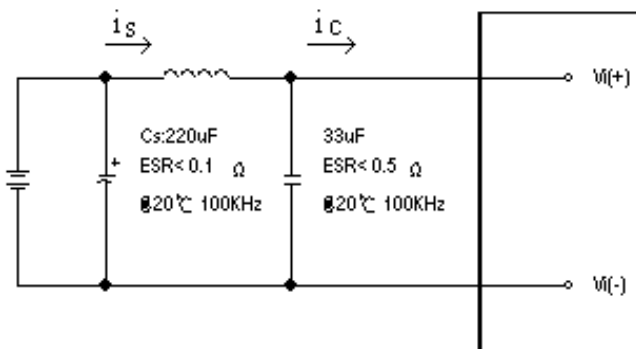
## ELECTRICAL CHARACTERISTICS CURVES



**Figure 8:** Output voltage response to step-change in load current (50%-75%-50% of  $I_o$ , max;  $di/dt = 0.1A/\mu s$ ;  $V_{in}$  is 24V). Load cap:  $10\mu F$  tantalum capacitor and  $1\mu F$  ceramic capacitor. Top Trace:  $V_{out}$  (0.2V/div, 100us/div), Bottom Trace:  $I_{out}$  (10A/div). Scope measurement should be made using a BNC cable (length shorter than 20 inches). Position the load between 51 mm to 76 mm (2 inches to 3 inches) from the module

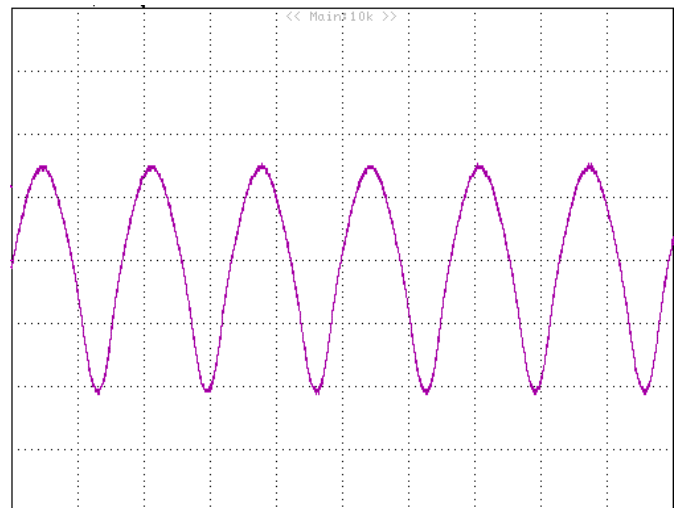


**Figure 9:** Output voltage response to step-change in load current (50%-75%-50% of  $I_o$ , max;  $di/dt = 0.1A/\mu s$ ;  $V_{in}$  is 48V). Load cap:  $10\mu F$  tantalum capacitor and  $1\mu F$  ceramic capacitor. Top Trace:  $V_{out}$  (0.2V/div, 100us/div), Bottom Trace:  $I_{out}$  (10A/div). Scope measurement should be made using a BNC cable (length shorter than 20 inches). Position the load between 51 mm to 76 mm (2 inches to 3 inches) from the module



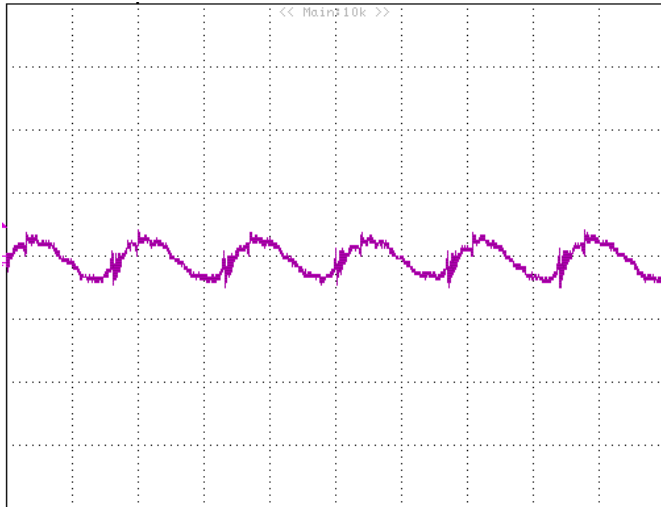
**Figure 10:** Test set-up diagram showing measurement points for Input Terminal Ripple Current and Input Reflected Ripple Current.

Note: Measured input reflected-ripple current with a simulated source Inductance ( $L_{TEST}$ ) of  $12\mu H$ . Capacitor  $C_s$  offset possible battery impedance. Measure current as shown above.

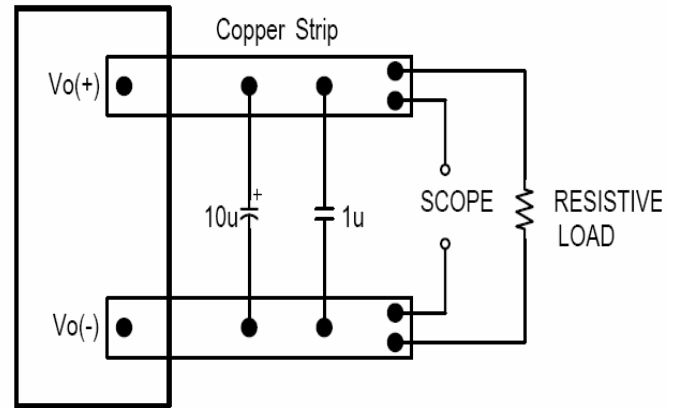


**Figure 11:** Input Terminal Ripple Current,  $i_c$ , at max output current and nominal input voltage with  $12\mu H$  source impedance and  $33\mu F$  electrolytic capacitor (500 mA/div, 2us/div).

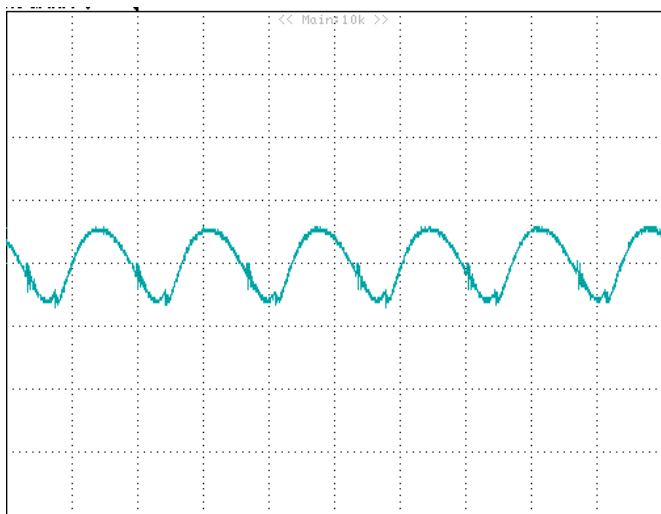
## ELECTRICAL CHARACTERISTICS CURVES



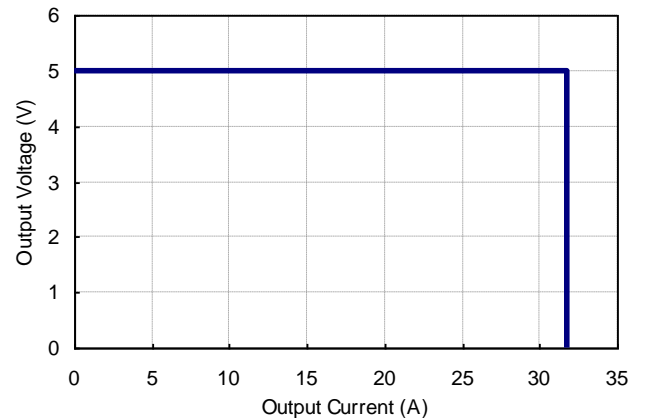
**Figure 12:** Input reflected ripple current,  $i_s$ , through a  $12\mu\text{H}$  source inductor at nominal input voltage and max load current (20 mA/div, 2  $\mu\text{s}$ /div).



**Figure 13:** Output voltage noise and ripple measurement test setup.



**Figure 14:** Output voltage ripple at nominal input voltage and max load current (50 mV/div, 2  $\mu\text{s}$ /div)  
Load capacitance:  $1\mu\text{F}$  ceramic capacitor and  $10\mu\text{F}$  tantalum capacitor. Bandwidth: 20 MHz.



**Figure 15:** Output voltage vs. load current showing typical current limit curves and converter shutdown points.

## DESIGN CONSIDERATIONS

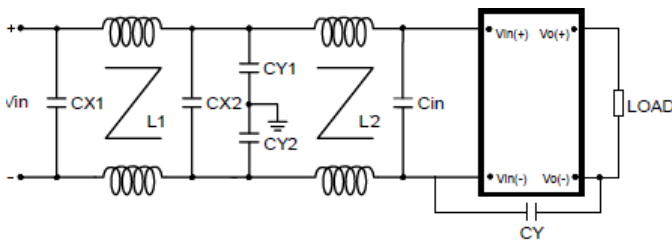
### Input Source Impedance

The impedance of the input source connecting to the DC/DC power modules will interact with the modules and affect the stability. A low ac-impedance input source is recommended. If the source inductance is more than a few  $\mu\text{H}$ , we advise 100 $\mu\text{F}$  electrolytic capacitor (ESR < 0.7  $\Omega$  at 100 kHz) mounted close to the input of the module to improve the stability.

### Layout and EMC Considerations

Delta's DC/DC power modules are designed to operate in a wide variety of systems and applications. For design assistance with EMC compliance and related PWB layout issues, please contact Delta's technical support team. An external input filter module is available for easier EMC compliance design. Below is the reference design for an input filter tested with E36SC05025 to meet class B in CISPR 22.

### Schematic and Components List



Cin is 100 $\mu\text{F}$  low ESR Aluminum cap:

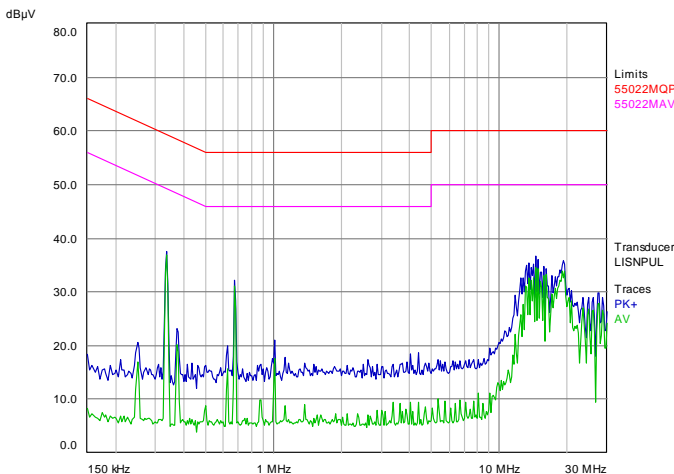
CY is 1nF ceramic cap:

CX1,CX2 are 2.2 $\mu\text{F}$  ceramic cap:

CY1,CY2 are 3.3nF ceramic cap:

L1,L2 are common-mode inductor ,L1=L2=0.63mH:

**Test Result:** Vin=48V, Io=25A,



Blue Line is quasi peak mode; green line is average mode.

### Safety Considerations

The power module must be installed in compliance with the spacing and separation requirements of the end-user's safety agency standard, i.e., UL60950-1, CSA C22.2 NO. 60950-1 2nd and IEC 60950-1 2nd : 2005 and EN 60950-1 2nd: 2006+A11+A1: 2010, if the system in which the power module is to be used must meet safety agency requirements.

Basic insulation based on 75 Vdc input is provided between the input and output of the module for the purpose of applying insulation requirements when the input to this DC-to-DC converter is identified as TNV-2 or SELV. An additional evaluation is needed if the source is other than TNV-2 or SELV.

When the input source is SELV circuit, the power module meets SELV (safety extra-low voltage) requirements. If the input source is a hazardous voltage which is greater than 60 Vdc and less than or equal to 75 Vdc, for the module's output to meet SELV requirements, all of the following must be met:

- The input source must be insulated from the ac mains by reinforced or double insulation.
- The input terminals of the module are not operator accessible.
- A SELV reliability test is conducted on the system where the module is used, in combination with the module, to ensure that under a single fault, hazardous voltage does not appear at the module's output.

When installed into a Class II equipment (without grounding), spacing consideration should be given to the end-use installation, as the spacing between the module and mounting surface have not been evaluated.

The power module has extra-low voltage (ELV) outputs when all inputs are ELV.

This power module is not internally fused. To achieve optimum safety and system protection, an input line fuse is highly recommended. The safety agencies require a normal-blow fuse with 20A maximum rating to be installed in the ungrounded lead. A lower rated fuse can be used based on the maximum inrush transient energy and maximum input current.

### Soldering and Cleaning Considerations

Post solder cleaning is usually the final board assembly process before the board or system undergoes electrical testing. Inadequate cleaning and/or drying may lower the reliability of a power module and severely affect the

reliability of a power module and severely affect the finished circuit board assembly test. Adequate cleaning and/or drying is especially important for un-encapsulated and/or open frame type power modules. For assistance on appropriate soldering and cleaning procedures, please contact Delta's technical support team.

## FEATURES DESCRIPTIONS

### Over-Current Protection

The modules include an internal output over-current protection circuit, which will endure current limiting for an unlimited duration during output overload. If the output current exceeds the OCP set point, the modules will shut down (hiccup mode).

The modules will try to restart after shutdown. If the overload condition still exists, the module will shut down again. This restart trial will continue until the overload condition is corrected.

### Over-Voltage Protection

The modules include an internal output over-voltage protection circuit, which monitors the voltage on the output terminals. If this voltage exceeds the over-voltage set point, the protection circuit will constrain the max duty cycle to limit the output voltage, if the output voltage continuously increases the modules will shut down, and then restart after a hiccup-time (hiccup mode).

### Over-Temperature Protection

The over-temperature protection consists of circuitry that provides protection from thermal damage. If the temperature exceeds the over-temperature threshold the module will shut down. The module will restart after the temperature is within specification.

### Remote On/Off

The remote on/off feature on the module can be either negative or positive logic. Negative logic turns the module on during a logic low and off during a logic high. Positive logic turns the modules on during a logic high and off during a logic low.

Remote on/off can be controlled by an external switch between the on/off terminal and the Vi (-) terminal. The switch can be an open collector or open drain. For negative logic if the remote on/off feature is not used, please short the on/off pin to Vi (-). For positive logic if the remote on/off feature is not used, please leave the on/off pin to floating.

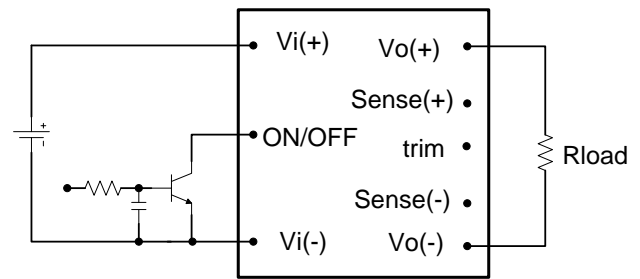


Figure 16: Remote on/off implementation

### Output Voltage Adjustment (TRIM)

To increase or decrease the output voltage set point, connect an external resistor between the TRIM pin and either the SENSE(+) or SENSE(-). The TRIM pin should be left open if this feature is not used.

For trim down, the external resistor value required to obtain a percentage of output voltage change  $\Delta\%$  is defined as:

$$R_{trim-down} = \left[ \frac{511}{\Delta} - 10.22 \right] (K\Omega)$$

Ex. When Trim-down -20% ( $5.0V \times 0.8 = 4.0V$ )

$$R_{trim-down} = \left[ \frac{511}{20} - 10.22 \right] (K\Omega) = 15.33(K\Omega)$$

For trim up, the external resistor value required to obtain a percentage output voltage change  $\Delta\%$  is defined as:

$$R_{trim-up} = \frac{5.11V_o(100+\Delta)}{1.225\Delta} - \frac{511}{\Delta} - 10.22(K\Omega)$$

Ex. When Trim-up +10% ( $5.0V \times 1.1 = 5.5V$ )

$$R_{trim-up} = \frac{5.11 \times 5.0 \times (100+10)}{1.225 \times 10} - \frac{511}{10} - 10.22 = 168(K\Omega)$$

The output voltage can be increased by both the remote sense and the trim, however the maximum increase is the larger of either the remote sense or the trim, not the sum of both.

When using remote sense and trim, the output voltage of the module is usually increased, which increases the power output of the module with the same output current.

Care should be taken to ensure that the maximum output power of the module remains at or below the maximum rated power.



## THERMAL CONSIDERATIONS

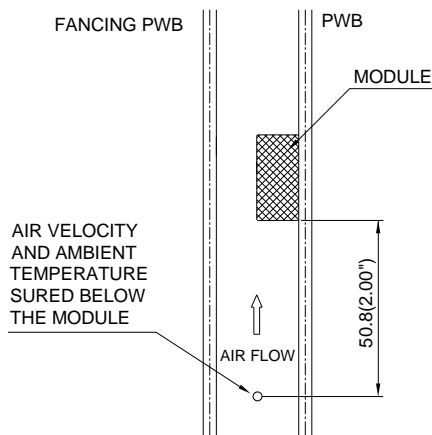
Thermal management is an important part of the system design. To ensure proper, reliable operation, sufficient cooling of the power module is needed over the entire temperature range of the module. Convection cooling is usually the dominant mode of heat transfer.

Hence, the choice of equipment to characterize the thermal performance of the power module is a wind tunnel.

### Thermal Testing Setup

Delta's DC/DC power modules are characterized in heated vertical wind tunnels that simulate the thermal environments encountered in most electronics equipment. This type of equipment commonly uses vertically mounted circuit cards in cabinet racks in which the power modules are mounted.

The following figure shows the wind tunnel characterization setup. The power module is mounted on a test PWB and is vertically positioned within the wind tunnel. The space between the neighboring PWB and the top of the power module is constantly kept at 6.35mm (0.25").



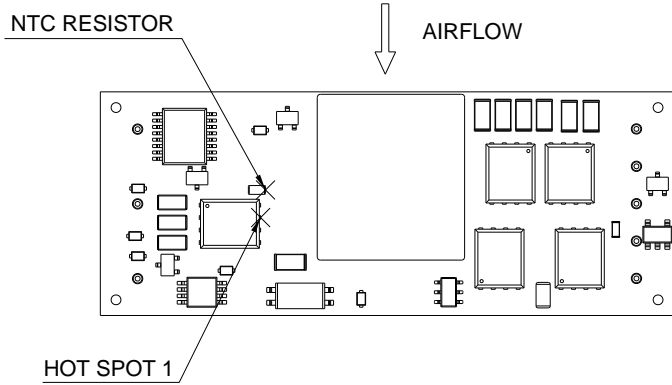
Note: Wind Tunnel Test Setup Figure Dimensions are in millimeters and (Inches)

**Figure 17:** Wind tunnel test setup

### Thermal Derating

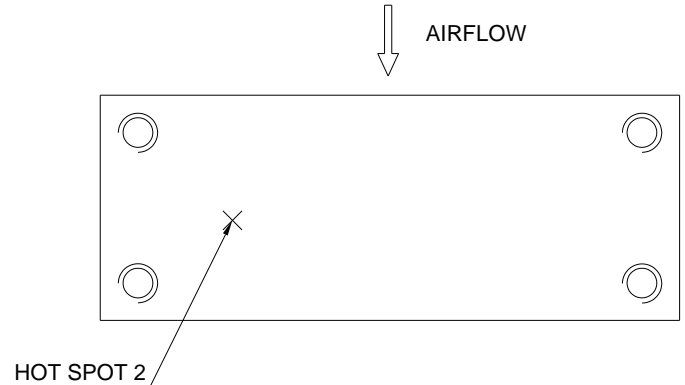
Heat can be removed by increasing airflow over the module. To enhance system reliability, the power module should always be operated below the maximum operating temperature. If the temperature exceeds the maximum module temperature, reliability of the unit may be affected.

## THERMAL CURVES (WITHOUT HEAT SPREADER)

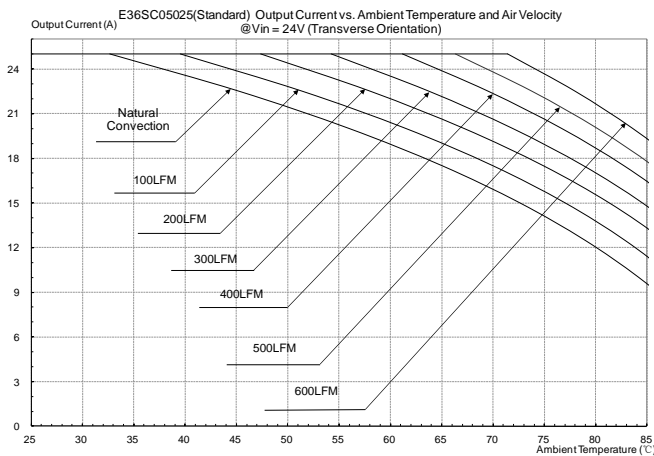


**Figure 18:** \* Hot spot 1 & NTC resistor temperature measured points. The allowed maximum hot spot temperature is defined at 116°C.

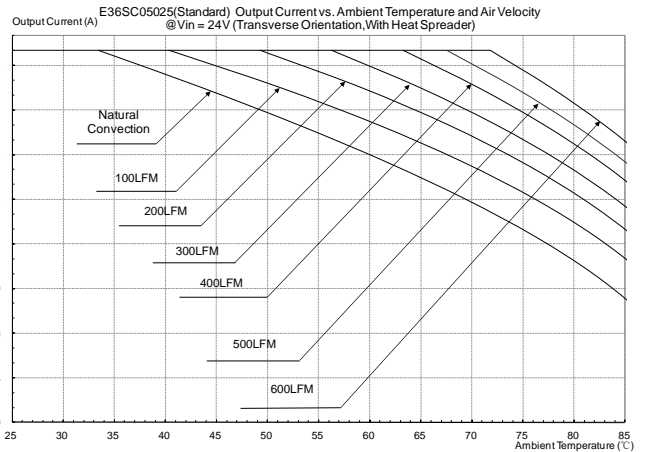
## THERMAL CURVES (WITH HEAT SPREADER)



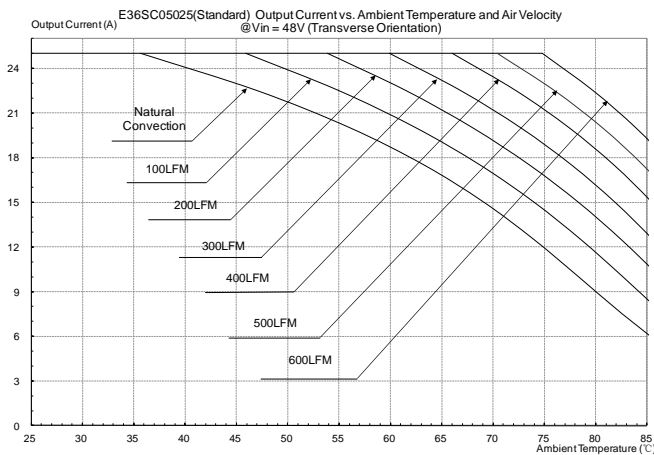
**Figure 21:** \* Hot spot 2 temperature measured point. The allowed maximum hot spot temperature is defined at 105°C.



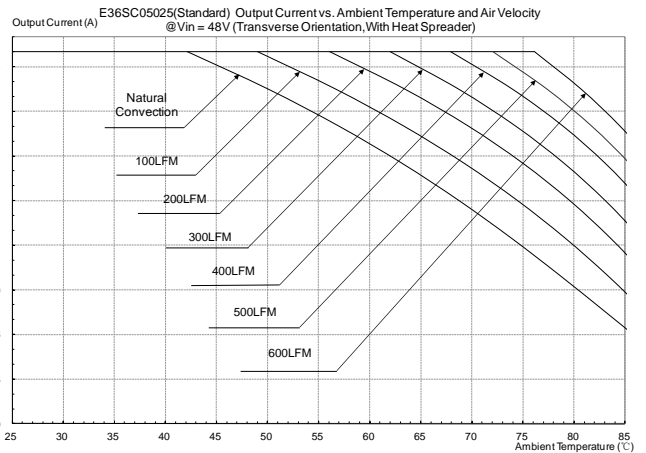
**Figure 19:** Output current vs. ambient temperature and air velocity @Vin=24V(Either Orientation, airflow from Vin+ to Vin-, without heat spreader)



**Figure 22:** Output current vs. ambient temperature and air velocity @Vin=24V(Either Orientation, airflow from Vin+ to Vin-, with heat spreader)

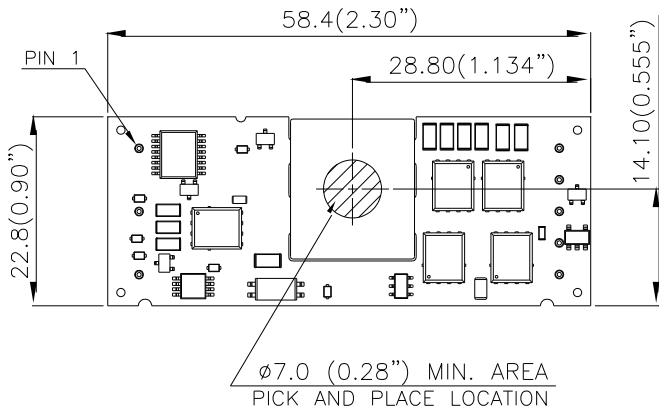


**Figure 20:** Output current vs. ambient temperature and air velocity @Vin=48V(Either Orientation, airflow from Vin+ to Vin-, without heat spreader)



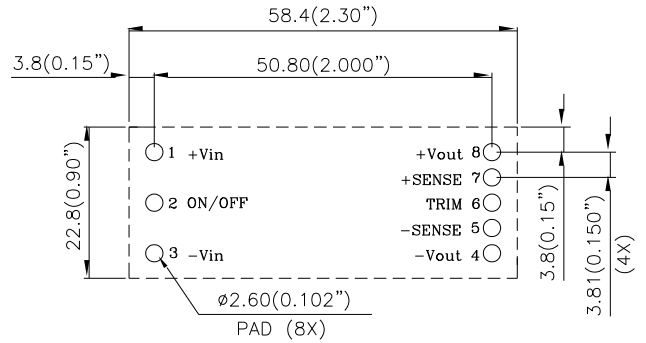
**Figure 23:** Output current vs. ambient temperature and air velocity @Vin=48V(Either Orientation, airflow from Vin+ to Vin-, with heat spreader)

## PICK AND PLACE LOCATION



NOTES:  
 DIMENSIONS ARE IN MILLIMETERS AND (INCHES)  
 TOLERANCES: X.Xmm±0.5mm(X.XX in.±0.02 in.)  
 X.XXmm±0.25mm(X.XXX in.±0.010 in.)

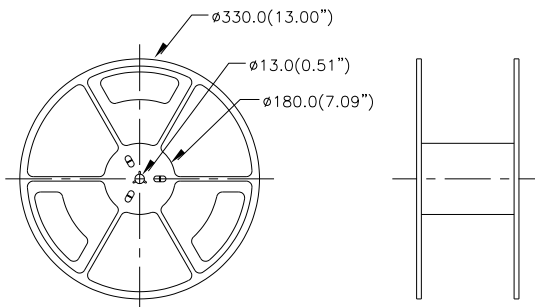
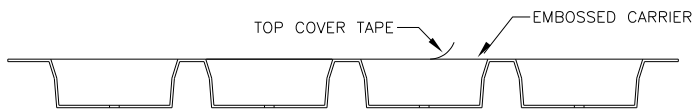
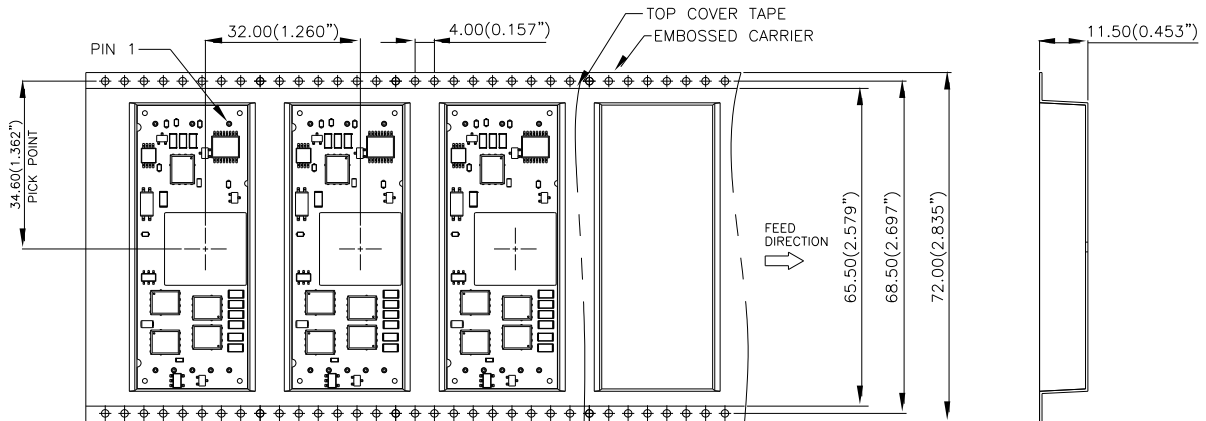
## RECOMMENDED PAD LAYOUT (SMD)



### RECOMENDED P.W.B. PAD LAYOUT

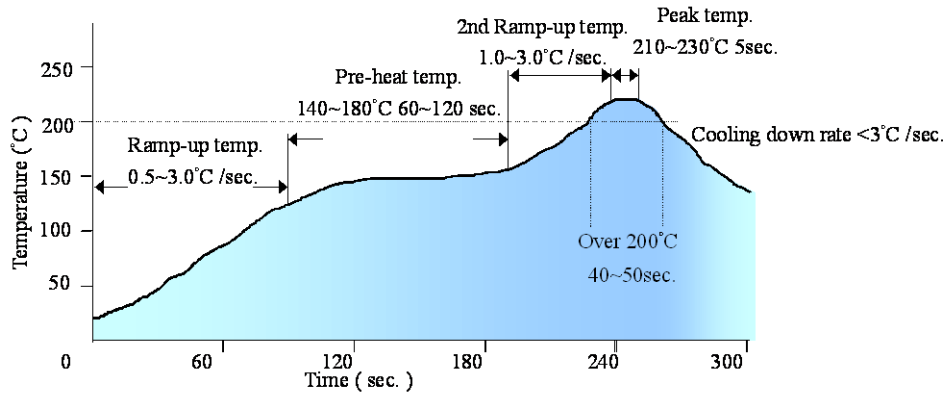
NOTES:  
 DIMENSIONS ARE IN MILLIMETERS AND (INCHES)  
 TOLERANCES: X.Xmm±0.5mm(X.XX in.±0.02 in.)  
 X.XXmm±0.25mm(X.XXX in.±0.010 in.)

## TAPE & REEL PACKAGE FOR SURFACE MOUNT MODELS



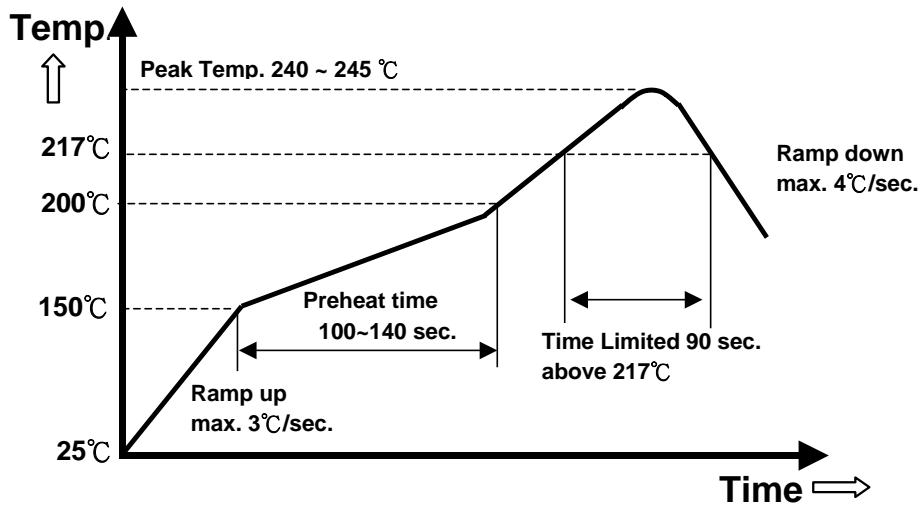
NOTES:  
 CONFORMS TO EIA-481 SATNDARD  
 MODULES ARE SHIPPED IN QUANTITIES OF 100 PER REEL.  
 ALL DIMENSIONS ARE IN MILLIMETERS AND (INCHES)  
 TOLERANCES: X.Xmm±0.5mm(X.XX in.±0.02 in.)  
 X.XXmm±0.25mm(X.XXX in.±0.010 in.)

**LEADED (Sn/Pb) PROCESS RECOMMEND TEMP. PROFILE(for SMD models)**



*Note: The temperature refers to the pin of E36SC, measured on the +Vout pin joint.*

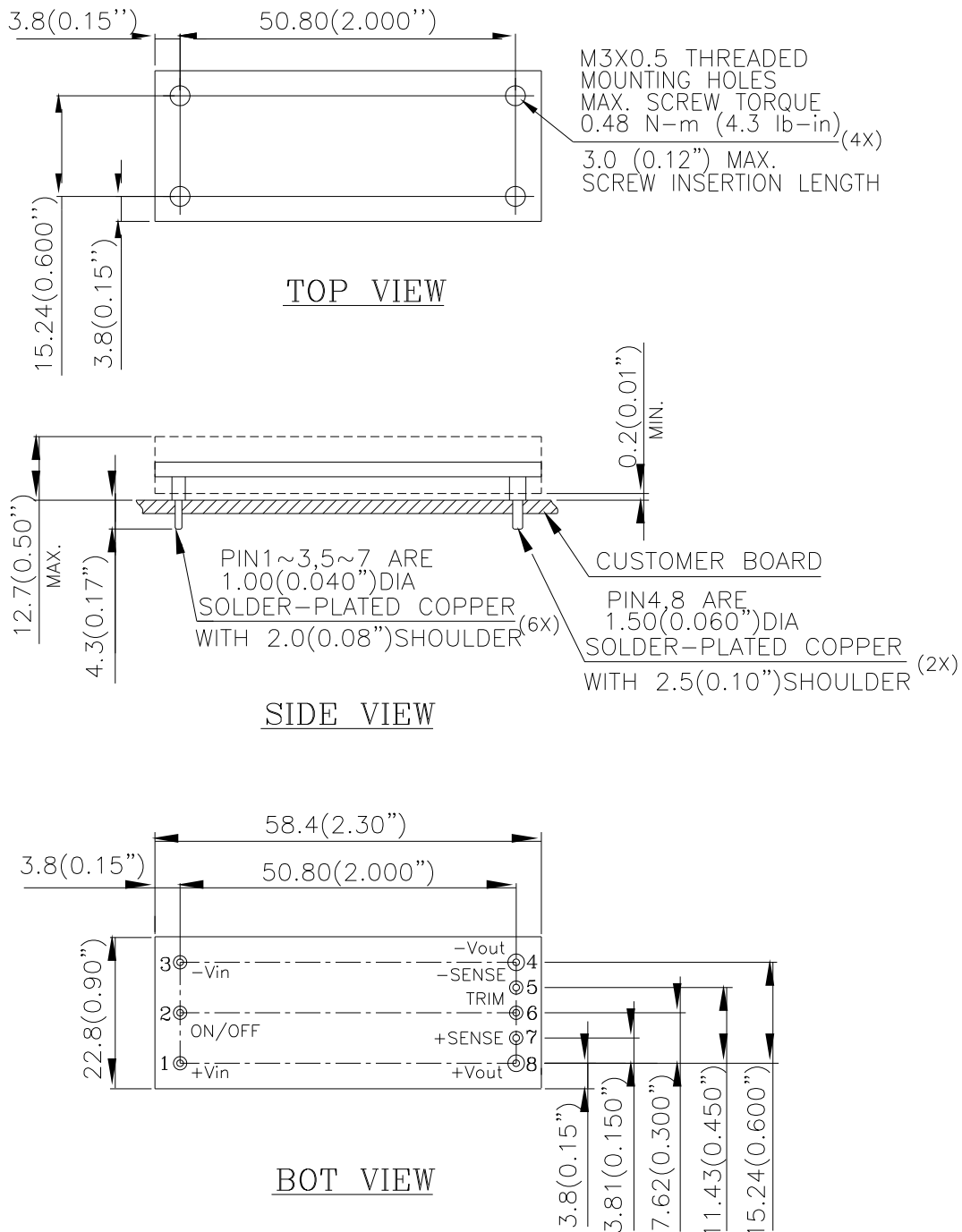
**LEAD FREE (SAC) PROCESS RECOMMEND TEMP. PROFILE(for SMD models)**



*Note: The temperature refers to the pin of E36SC05025, measured on the +Vout pin joint.*

## MECHANICAL DRAWING (WITH HEAT SPREADER)

**For modules with through-hole pins and the optional heatspreader, they are intended for wave soldering assembly onto system boards; please do not subject such modules through reflow temperature profile.**



**NOTES:**

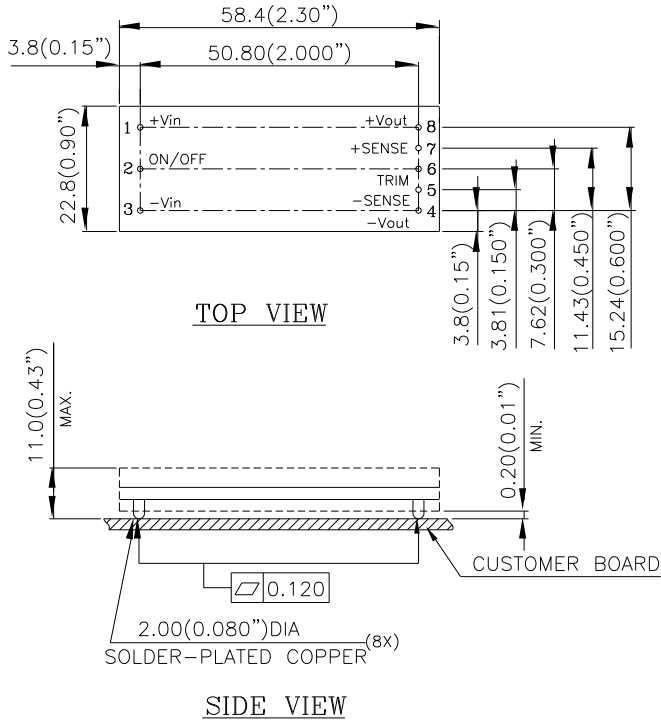
DIMENSIONS ARE IN MILLIMETERS AND (INCHES)

TOLERANCES: X.Xmm±0.5mm(X.XX in.±0.02 in.)

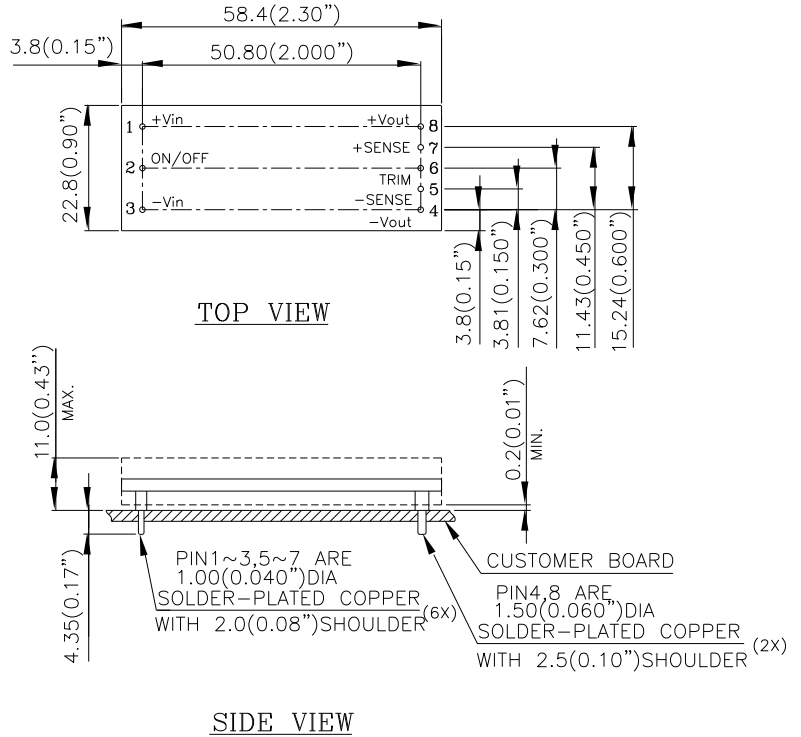
X.XXmm±0.25mm(X.XXX in.±0.010 in.)

## MECHANICAL DRAWING (WITHOUT HEAT SPREADER)

### Surface-mount module



### Through-hole module



NOTES:  
 DIMENSIONS ARE IN MILLIMETERS AND (INCHES)  
 TOLERANCES: X.Xmm±0.5mm(X.XX in.±0.02 in.)  
 X.XXmm±0.25mm(X.XXX in.±0.010 in.)

Pin No.	Name	Function
1	+Vin	Positive input voltage
2	ON/OFF	Remote ON/OFF
3	-Vin	Negative input voltage
4	-Vout	Negative output voltage
5	-SENSE	Negative remote sense
6	TRIM	Output voltage trim
7	+SENSE	Positive remote sense
8	+Vout	Positive output voltage

#### Pin Specification:

Pins 1-3,5-7      1.00mm (0.040") diameter  
 Pins 4 & 8      1.50mm (0.059") diameter

Note: All pins are copper alloy with matte Tin(Pb free) plated over Nickel under plating.



## PART NUMBERING SYSTEM

E	36	S	C	050	25	N	K	F	A
Form Factor	Input Voltage	Number of Outputs	Product Series Number	Output Voltage	Output Current	ON/OFF Logic	Pin Length		Option Code
E - 1/8 Brick	36- 18V~75V	S – Single	C- Series Number	050- 5.0V	25- 25A	N – Negative	K – 0.110” N - 0.145” R - 0.170” M - SMD pin	F - RoHS 6/6 (Lead Free) Space - RoHS5/6	A – Standard Function H– With Heatspreader

## MODEL LIST

MODEL NAME	INPUT	OUTPUT	EFF @ 100% LOAD
E36SC05025NKFA	18V~75V	8.9A	91.0% @ 48Vin

*Default remote on/off logic is negative and pin length is 0.170”*

*For different remote on/off logic and pin length, please refer to part numbering system above or contact your local sales office.*

*For modules with through-hole pins and the optional heatspreader, they are intended for wave soldering assembly onto system boards; please do not subject such modules through reflow temperature profile.*

**CONTACT:** [www.deltaww.com/dcdc](http://www.deltaww.com/dcdc)

### USA:

Telephone:  
East Coast: 978-656-3993  
West Coast: 510-668-5100  
Fax: (978) 656 3964  
Email: [DCDC@delta-corp.com](mailto:DCDC@delta-corp.com)

### Europe:

Phone: +31-20-655-0967  
Fax: +31-20-655-0999  
Email: [DCDC@delta-es.com](mailto:DCDC@delta-es.com)

### Asia & the rest of world:

Telephone: +886 3 4526107  
ext 6220~6224  
Fax: +886 3 4513485  
Email: [DCDC@delta.com.tw](mailto:DCDC@delta.com.tw)

## WARRANTY

Delta offers a two (2) year limited warranty. Complete warranty information is listed on our web site or is available upon request from Delta.

Information furnished by Delta is believed to be accurate and reliable. However, no responsibility is assumed by Delta for its use, nor for any infringements of patents or other rights of third parties, which may result from its use. No license is granted by implication or otherwise under any patent or patent rights of Delta. Delta reserves the right to revise these specifications